

CATALOGO GENERALE

GAZZINI
CERAMICA & DESIGN

COLLECTIONS 2021-2022

**design
materia
qualità**

made in Italy

GAZZINI
CERAMICA & DESIGN

**Since 1965,
a history of design.**

Gazzini is an Italian company that since 1965 is offering porcelain stoneware solutions capable of satisfying all architectural and interior design needs. A brand recognized internationally as a synonym of quality for floors and walls, a symbol of creativity and the best Italian know-how of 50 years.

**Depuis le 1965,
une histoire de design.**

Gazzini est une entreprise italienne qui propose, depuis le 1965, des solutions en grès cérame capables de satisfaire tous les besoins dans les domaines de l'architecture et de la décoration intérieure. Une marque reconnue internationalement comme synonyme de qualité pour les sols et les murs, symbole de créativité et du meilleur savoir-faire italien depuis 50 ans.

**Seit 1965
eine Geschichte für Designs.**

Gazzini ist ein italienisches Unternehmen, das seit 1965 Platten aus Feinsteinzeug anbietet, die alle Anforderungen im Bereich Architektur und Interior Design erfüllen. Eine Marke, die international als Synonym für Qualität für Böden und Wände anerkannt ist, ein Symbol für Kreativität und das beste italienische Know-how seit 50 Jahren.

Dal 1965, una storia di design.

Gazzini è una realtà italiana che dal 1965 propone soluzioni in gres porcellanato capaci di soddisfare tutte le esigenze in ambito architettonico e di interior design.

Un brand riconosciuto a livello internazionale come sinonimo di qualità per pavimenti e rivestimenti, simbolo da 50 anni di creatività e del miglior saper fare italiano.



GAZZINI
CERAMICA & DESIGN

Un partner strategico.

Sappiamo innovare grazie ad un confronto quotidiano con i nostri interlocutori.

Centralità del cliente, ricerca e sostenibilità sono infatti i punti di forza della nostra politica imprenditoriale: valori fondamentali ed imprescindibili che uniti all'attitudine di saper cogliere le evoluzioni dell'abitare, sottolineano l'innovazione ed affidabilità delle proposte Gazzini.

A strategic partner.

Thanks to a daily feedback from our business partners we know how to innovate.

Customer centrality, research and sustainability are in fact the strengths of our company policy: fundamental and essential values which, combined with the attitude of being able to grasp the evolution of living, underline the innovation and reliability of Gazzini's proposals.

Un partenaire stratégique.

Nous savons innover grâce à une discussion quotidienne avec nos interlocuteurs.

Centralité du client, recherche et durabilité, sont en effet les points de force de notre politique entrepreneuriale : des valeurs fondamentales et essentielles qui, combinées à l'attitude de savoir intercepter l'évolution de l'habitat, soulignent l'innovation et la fiabilité des propositions Gazzini.

Ein strategischer Partner.

Dank einer täglichen Diskussion mit unseren Gesprächspartnern wissen wir, wie man innovativ sein kann.

Kundenzentralität, Forschung und Nachhaltigkeit sind eigentlich die Stärken unserer unternehmerischen Politik: grundlegende und wesentliche Werte, die zusammen mit der Einstellung, die Entwicklung des Lebens zu erfassen, die Innovation und Zuverlässigkeit von Gazzini's Vorschlägen unterstreichen.



Stile e cultura del prodotto.

Le nostre collezioni combinano eccellenza tecnologica alla profonda passione per il prodotto: soluzioni versatili e dal gusto contemporaneo, caratterizzate dalla cura di ogni dettaglio e dalla sofisticata purezza estetica.

Un percorso di suggestioni stilistiche in continua evoluzione che delinea nuove prospettive nel panorama del progetto e dell'architettura.

Product style and culture.

Our collections combine technological excellence with a deep passion for the product: versatile solutions with a contemporary taste, characterized by the attention to every detail and by the valuable aesthetic purity. A path of constantly evolving stylistic suggestions, which outlines new perspectives in the landscape of design and architecture.

Style et culture du produit.

Nos collections combinent l'excellence technologique avec une profonde passion pour le produit : des solutions polyvalentes avec un goût contemporain, caractérisées par l'attention portée à chaque détail et par la précieuse pureté esthétique. Un chemin de suggestions stylistiques en constante évolution qui présente des nouvelles perspectives dans le cadre du projet et de l'architecture.

Produktstil und Kultur.

Unsere Kollektionen verbinden technologische Spitzenleistungen mit einer tiefen Leidenschaft für das Produkt: vielseitige Lösungen mit zeitgemäßem Geschmack, die sich durch die Liebe zum Detail und die wertvolle ästhetische Reinheit auszeichnen. Ein Weg sich ständig weiterentwickelnder Stilvorschläge, der neue Perspektiven in der Landschaft von Design und Architektur aufzeigt.





codice
code
code
Kode

descrizione e formato
description and size
description et format
Beschreibung und Format

prezzo
price
prix
Preis

041015
SLIDE BLACK RETTIFICATO 30x30
Cod. **78** □

IMBALLI • PACKAGES • EMBALLAGES • FORMATE

	SCATOLA • BOX • BOITE • KARTON			PALLET • PALLETS • PALETTS • PALETTE		
	<i>pz</i>	<i>mq</i>	<i>kg</i>	<i>box</i>	<i>mq</i>	<i>kg</i>
30x30	11	0,99	23,00	46	45,54	1.058,00

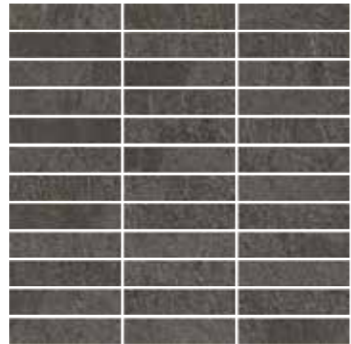

codice
code
code
Kode

descrizione e formato
description and size
description et format
Beschreibung und Format

prezzo
price
prix
Preis

041021
SLIDE BLACK MOSAICO 2,4x10
SU RETE 30x30 Cod. **46** ○

pezzi per scatola
pieces each box
pièces par boîte
Stückzahl je Karton

peso scatola
box weight
poids par boîte
Gewicht je Karton

11
19,60 kg

□ = mq
○ = pz
△ = ml

Dal 1965, una storia di design...	2
Un partner strategico	4
Stile e cultura del prodotto	6
Guida al catalogo	8
Indice analitico	10
Artwork	12
Deco Style	32
Essential	40
Factory	52
Fossil	64
Fusion	68
Glamstone	82
Iconic Blue	94
Landscape	100
Les Bois	108
Look	116
Luxury Grey	128
Marmobianco	134
Marquinia Black	140
Metal Art	146
Met	158
Move	166
New Arabescato	182
Opus Stone	188
Platform	198
Premium Onyx	218
Quarry	224
Quarz	232
Royal Marbles	242
Slide	252
Stage	264
Stat One	274
Stone Selection	282
Stream	296
Stylish Taupe	302
Urban Style	308
Venato Select	314
Vintage	322
White Dolomite	332
White Onyx	340
Woodland	346
Condizioni generali di vendita	354

MADE IN ITALY



ARTWORK	Artwork Grigio.....	14
ARTWORK	Artwork Piombo.....	18
ARTWORK	Artwork Sabbia.....	22
ARTWORK	Artwork Tortora.....	26
DECO STYLE	Deco Style White.....	34
DECO STYLE	Deco Style Beige.....	35
DECO STYLE	Deco Style Grey.....	36
DECO STYLE	Deco Style Charcoal.....	37
ESSENTIAL	Essential Taupe.....	42
ESSENTIAL	Essential Sand.....	44
ESSENTIAL	Essential Mud.....	46
ESSENTIAL	Essential Grey.....	48
FACTORY	Factory White.....	54
FACTORY	Factory Grey.....	56
FACTORY	Factory Smoke.....	58
FACTORY	Factory Black.....	60
FOSSIL	Fossil.....	66
FUSION	Fusion Antracite.....	70
FUSION	Fusion Beige.....	72
FUSION	Fusion Bianco.....	74
FUSION	Fusion Grigio.....	76
FUSION	Fusion Tortora.....	78
GLAMSTONE	Glamstone Namibian Grey.....	84
GLAMSTONE	Glamstone Palissandro White.....	86
GLAMSTONE	Glamstone Breach Cream.....	88
GLAMSTONE	Glamstone Calacatta Ivory.....	90
ICONIC BLUE	Iconic Blue.....	96
LANDSCAPE	Landscape Black.....	102
LANDSCAPE	Landscape Grey.....	103
LANDSCAPE	Landscape Ivory.....	104
LANDSCAPE	Landscape Mud.....	105
LES BOIS	Les Bois St. Tropez.....	110
LES BOIS	Les Bois Antibes.....	111
LES BOIS	Les Bois Biarritz.....	112
LOOK	Look White.....	118
LOOK	Look Gray.....	120
LOOK	Look Dark.....	122
LOOK	Look Mud.....	124
LUXURY GREY	Luxury Grey.....	130
MARMOBIANCO	Marmobianco.....	136
MARQUINIA BLACK	Marquinia Black.....	142

METAL ART	Metal Art Black.....	148
METAL ART	Metal Art Grey.....	150
METAL ART	Metal Art Ivory.....	152
METAL ART	Metal Art Taupe.....	154
MET	Met Antracite.....	160
MET	Met Brown.....	161
MET	Met Grey.....	162
MET	Met Smoke.....	163
MET	Met White.....	164
MOVE	Move Black.....	168
MOVE	Move Beige.....	170
MOVE	Move Grey.....	172
MOVE	Move Ivory.....	174
MOVE	Move Mud.....	176
NEW ARABESCATO	New Arabescato.....	184
OPUS STONE	Opus Stone Avorio.....	190
OPUS STONE	Opus Stone Grigio.....	191
OPUS STONE	Opus Stone Beige.....	192
OPUS STONE	Opus Stone Tortora.....	193
OPUS STONE	Opus Stone Blu.....	194
PLATFORM	Platform Powder.....	200
PLATFORM	Platform Sage.....	204
PLATFORM	Platform Blue.....	208
PLATFORM	Platform Bronze.....	212
PREMIUM ONYX	Premium Onyx.....	220
QUARRY	Quarry Gold.....	226
QUARRY	Quarry Ivory.....	227
QUARRY	Quarry Taupe.....	228
QUARRY	Quarry Grey.....	229
QUARZ	Quarz Antracite.....	234
QUARZ	Quarz Beige.....	235
QUARZ	Quarz Grey.....	236
QUARZ	Quarz Taupe.....	237
ROYAL MARBLES	R.M. Light Bardiglio.....	244
ROYAL MARBLES	R.M. Marfil Select.....	246
ROYAL MARBLES	R.M. Royal Gold.....	248
SLIDE	Slide Black.....	254
SLIDE	Slide Grey.....	256
SLIDE	Slide White.....	258
STAGE	Stage Cozy.....	266
STAGE	Stage Hipster.....	268

STAGE	Stage Shabby Chic.....	270
STAT ONE	Stat One.....	276
STONE SELECTION	S. S. Dark Cloud.....	284
STONE SELECTION	S. S. Dolmen White.....	286
STONE SELECTION	S. S. New Grey.....	288
STONE SELECTION	S. S. Moon Cream.....	290
STREAM	Stream Caramel.....	298
STREAM	Stream Avorio.....	299
STYLISH TAUPE	Stylish Taupe.....	304
URBAN STYLE	Urban Style Grigio.....	310
URBAN STYLE	Urban Style Sabbia.....	311
VENATO SELECT	Venato Select.....	316
VINTAGE	Vintage Terra.....	324
VINTAGE	Vintage Tortora.....	325
VINTAGE	Vintage Cotto.....	326
VINTAGE	Vintage Ecru.....	327
VINTAGE	Vintage Blu.....	328
WHITE DOLOMITE	White Dolomite.....	334
WHITE ONYX	White Onyx.....	342
WOODLAND	Woodland Brown.....	348
WOODLAND	Woodland Honey.....	349
WOODLAND	Woodland Taupe.....	350
WOODLAND	Woodland Vanilla.....	351



Tipologia
Type
Typologie
Typ
Gres porcellanato smaltato
Glazed porcelain
Grès cérame emaille
Feinsteinzeug glasiert

Formati
Sizes
Formats
Formate
120x280
90x90
45x90
60x60
30x60
10x60
10x30
5x20

Spessore
Thickness
Épaisseur
Stärke
6 mm
10 mm

Resistenza scivolosità
Sliding resistance
Resistance au glissement
Rutschfestigkeit
R10 / A+B

Grado di variazione cromatica
Degree of colour change
Degré de variation chromatique
Grad der Farbabweichung
V3



120284
ARTWORK GRIGIO RETTIFICATO 120x280
Cod. 112 □

✕ 6 mm

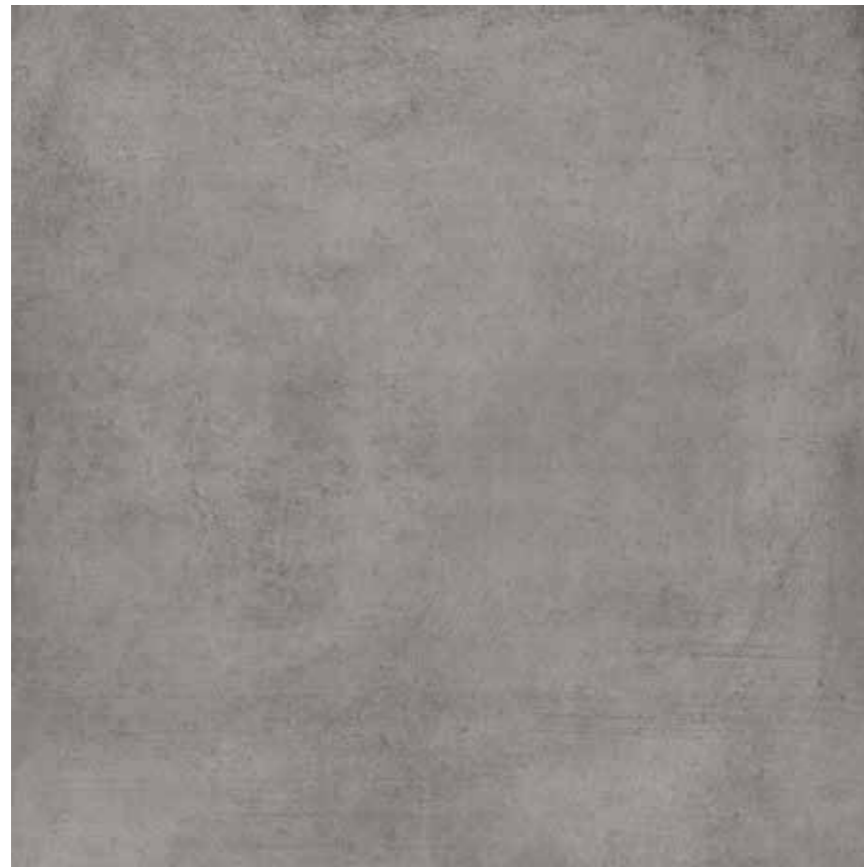

909040
ARTWORK GRIGIO RETTIFICATO 90x90
Cod. **97** □



459031
ARTWORK GRIGIO RETTIFICATO 45x90
Cod. **90** □

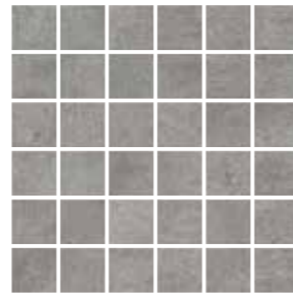

12,30 kg

041201
ARTWORK GRIGIO MOSAICO 5x5
SU RETE 30x30 Cod. **24** ○



12,30 kg

501146
ARTWORK GRIGIO FRAME 2,5x7,5
SU RETE 30x30 Cod. **28** ○

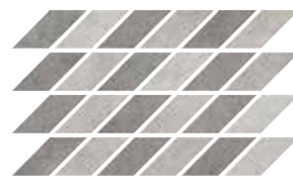

8,20 kg

203001
ARTWORK GRIGIO/SABBIA MOS.
FAIRYTALE SU RETE 20x30 Cod. **43** ○



606214
ARTWORK GRIGIO RETTIFICATO 60x60
Cod. **79** □



490662
ARTWORK GRIGIO RETTIFICATO 30x60
Cod. **76** □



106016
ARTWORK GRIGIO RETTIFICATO 10x60
Cod. **83** □



103121
ARTWORK GRIGIO RETTIFICATO 10x30
Cod. **77** □



7,50 kg

380282
ARTWORK GRIGIO MULTILEVEL SU RETE 19,5x48,8
Cod. **40** ○



050227
ARTWORK GRIGIO RETTIFICATO 5x20
Cod. **93** □

IMBALLI • PACKAGES • EMBALLAGES • FORMATE

	SCATOLA • BOX • BOITE • KARTON			PALLET • PALLETS • PALETTS • PALETTE		
	pz	mq	kg	box	mq	kg
90x90	2	1,62	35,95	20	32,40	745,00
45x90	3	1,22	25,20	32	39,04	830,00
60x60	3	1,08	21,20	40	43,20	875,00
30x60	6	1,08	21,00	40	43,20	865,00
10x60	12	0,72	15,40	60	43,20	950,00
10x30	20	0,60	14,00	60	36,00	850,00
5x20	56	0,56	14,00	60	33,60	850,00

	CASSA • CRATE • CAISSE • HOLZKISTE			CAVALLETTO • A-FRAME • CHEVALET • TRANSPORTGESTELL					
	pz	mq	kg	pz	mq	kg			
120x280	1	3,36	47,04	20	67,20	1.090,00	44	147,84	2.220,00



120285
ARTWORK PIOMBO RETTIFICATO 120x280
Cod. 112 □

6 mm

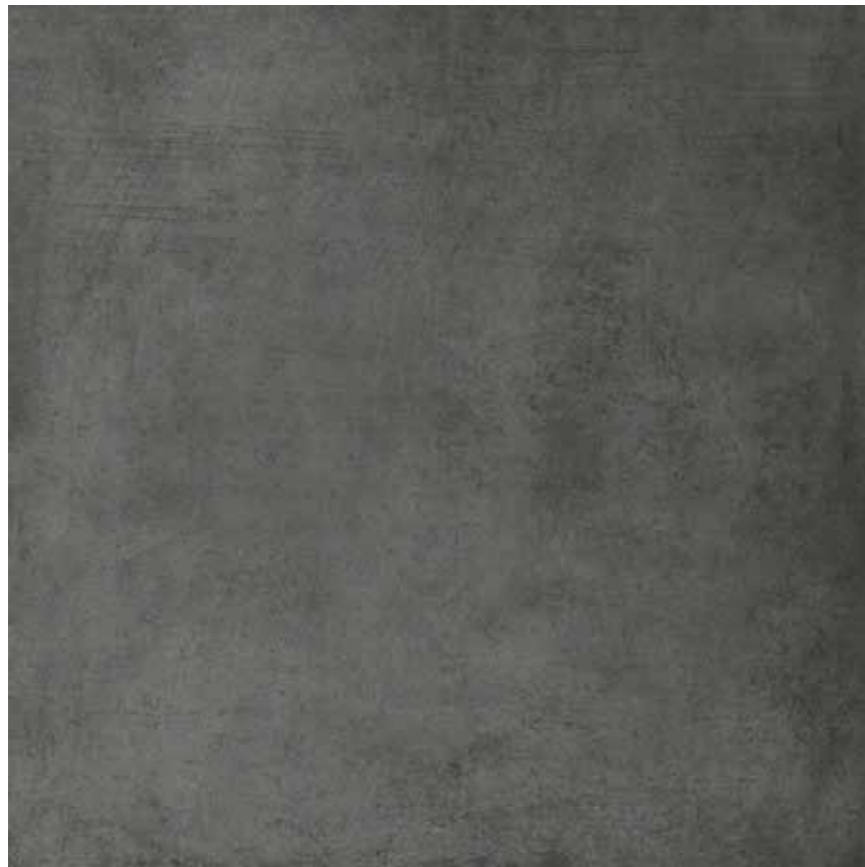

909042
ARTWORK PIOMBO RETTIFICATO 90x90
Cod. **97** □



459032
ARTWORK PIOMBO RETTIFICATO 45x90
Cod. **90** □



041202
ARTWORK PIOMBO MOSAICO 5x5
SU RETE 30x30 Cod. **24** ○



12,30 kg

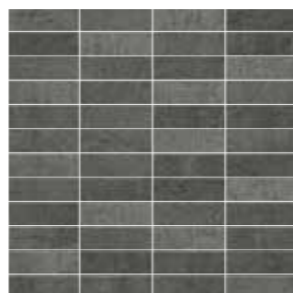

501147
ARTWORK PIOMBO FRAME 2,5x7,5
SU RETE 30x30 Cod. **28** ○



12,30 kg

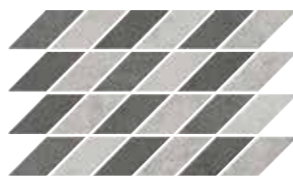

203002
ARTWORK PIOMBO/SABBIA MOS.
FAIRYTALE SU RETE 20x30 Cod. **43** ○



8,20 kg



606215
ARTWORK PIOMBO RETTIFICATO 60x60
Cod. **79** □



490663
ARTWORK PIOMBO RETTIFICATO 30x60
Cod. **76** □



106017
ARTWORK PIOMBO RETTIFICATO 10x60
Cod. **83** □



103122
ARTWORK PIOMBO RETTIFICATO 10x30
Cod. **77** □



380283
ARTWORK PIOMBO MULTILEVEL SU RETE 19,5x48,8
Cod. **40** ○



7,50 kg



050228
ARTWORK PIOMBO RETTIFICATO 5x20
Cod. **93** □

IMBALLI • PACKAGES • EMBALLAGES • FORMATE

	SCATOLA • BOX • BOITE • KARTON			PALLET • PALLETS • PALETTS • PALETTE		
	pz	mq	kg	box	mq	kg
90x90	2	1,62	35,95	20	32,40	745,00
45x90	3	1,22	25,20	32	39,04	830,00
60x60	3	1,08	21,20	40	43,20	875,00
30x60	6	1,08	21,00	40	43,20	865,00
10x60	12	0,72	15,40	60	43,20	950,00
10x30	20	0,60	14,00	60	36,00	850,00
5x20	56	0,56	14,00	60	33,60	850,00

	CASSA • CRATE • CAISSE • HOLZKISTE			CAVALLETTO • A-FRAME • CHEVALET • TRANSPORTGESTELL					
	pz	mq	kg	pz	mq	kg			
120x280	1	3,36	47,04	20	67,20	1.090,00	44	147,84	2.220,00



120286
ARTWORK SABBIA RETTIFICATO 120x280
Cod. 112 □

6 mm

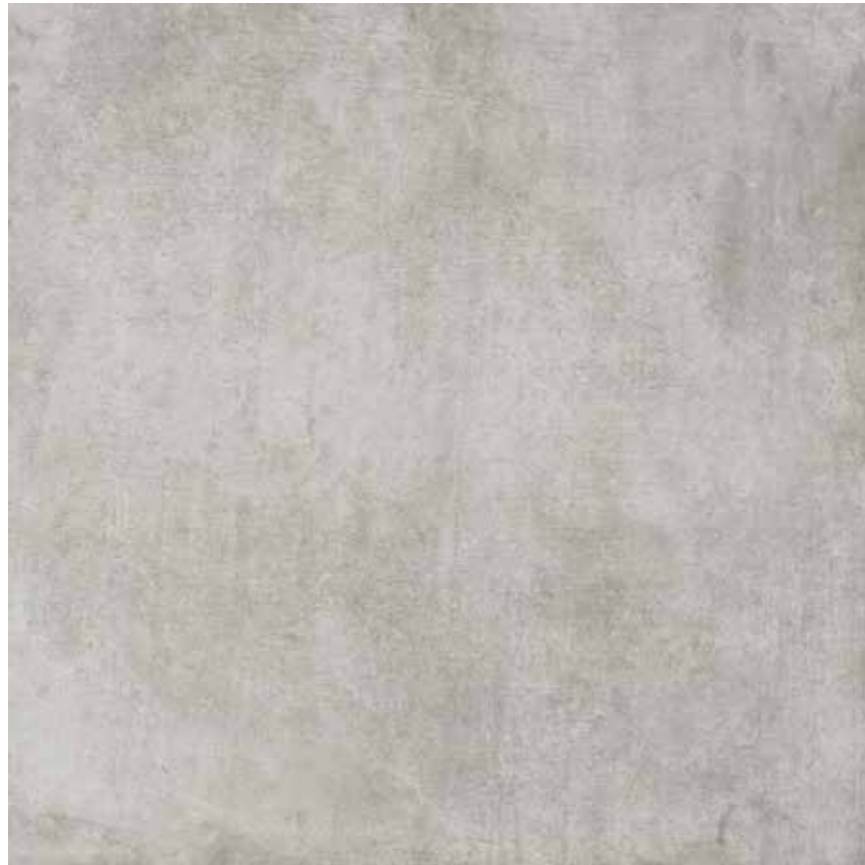

909041
ARTWORK SABBIA RETTIFICATO 90x90
Cod. **97** □



459033
ARTWORK SABBIA RETTIFICATO 45x90
Cod. **90** □



12,30 kg

041203
ARTWORK SABBIA MOSAICO 5x5
SU RETE 30x30 Cod. **24** ○

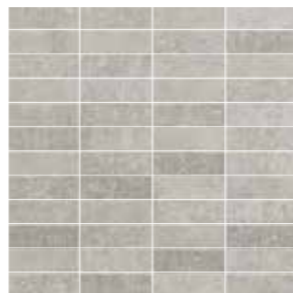

12,30 kg

501148
ARTWORK SABBIA FRAME 2,5x7,5
SU RETE 30x30 Cod. **28** ○

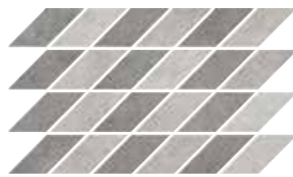

8,20 kg

203001
ARTWORK GRIGIO/SABBIA MOS.
FAIRYTALE SU RETE 20x30 Cod. **43** ○

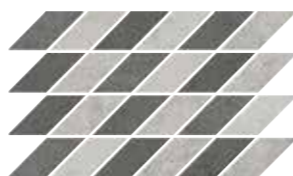

8,20 kg

203002
ARTWORK PIOMBO/SABBIA MOS.
FAIRYTALE SU RETE 20x30 Cod. **43** ○

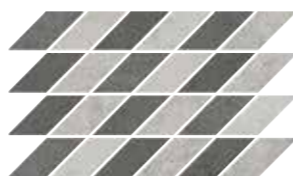

8,20 kg

203003
ARTWORK TORTORA/SABBIA MOS.
FAIRYTALE SU RETE 20x30 Cod. **43** ○



606216
ARTWORK SABBIA RETTIFICATO 60x60
Cod. **79** □



490664
ARTWORK SABBIA RETTIFICATO 30x60
Cod. **76** □



106018
ARTWORK SABBIA RETTIFICATO 10x60
Cod. **83** □



103123
ARTWORK SABBIA RETTIFICATO 10x30
Cod. **77** □



7,50 kg

380284
ARTWORK SABBIA MULTILEVEL
SU RETE 19,5x48,8 Cod. **40** ○



050229
ARTWORK SABBIA RETTIFICATO 5x20
Cod. **93** □

IMBALLI • PACKAGES • EMBALLAGES • FORMATE

	SCATOLA • BOX • BOITE • KARTON			PALLET • PALLETS • PALETTS • PALETTE		
	pz	m ^q	kg	box	m ^q	kg
90x90	2	1,62	35,95	20	32,40	745,00
45x90	3	1,22	25,20	32	39,04	830,00
60x60	3	1,08	21,20	40	43,20	875,00
30x60	6	1,08	21,00	40	43,20	865,00
10x60	12	0,72	15,40	60	43,20	950,00
10x30	20	0,60	14,00	60	36,00	850,00
5x20	56	0,56	14,00	60	33,60	850,00

	CASSA • CRATE • CAISSE • HOLZKISTE			CAVALLETTO • A-FRAME • CHEVALET • TRANSPORTGESTELL					
	pz	m ^q	kg	pz	m ^q	kg			
120x280	1	3,36	47,04	20	67,20	1.090,00	44	147,84	2.220,00



120287
ARTWORK TORTORA RETTIFICATO 120x280
Cod. 112 □

6 mm

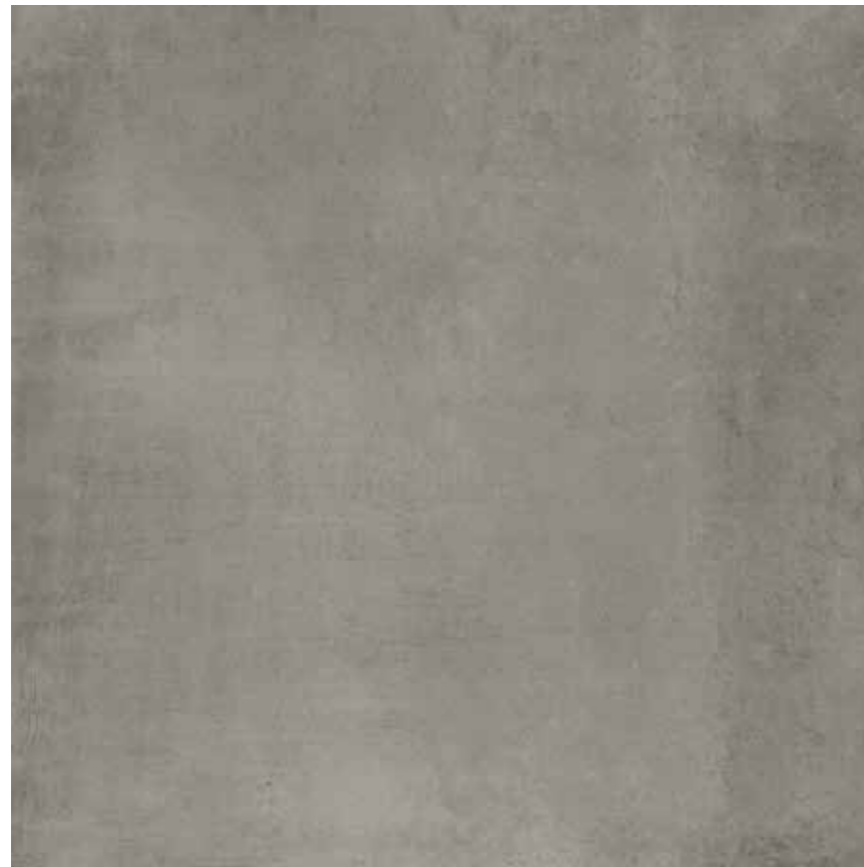

909039
ARTWORK TORTORA RETTIFICATO 90x90
Cod. **97** □



459030
ARTWORK TORTORA RETTIFICATO 45x90
Cod. **90** □

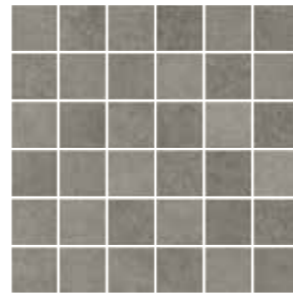

12,30 kg

041200
ARTWORK TORTORA MOSAICO 5x5
SU RETE 30x30 Cod. **24** ○

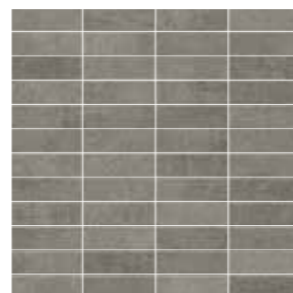

12,30 kg

501145
ARTWORK TORTORA FRAME 2,5x7,5
SU RETE 30x30 Cod. **28** ○

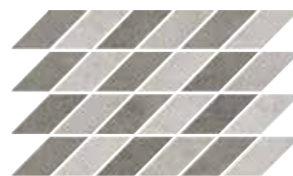

8,20 kg

203003
ARTWORK TORTORA/SABBIA MOS.
FAIRYTALE SU RETE 20x30 Cod. **43** ○



606213
ARTWORK TORTORA RETTIFICATO 60x60
Cod. **79** □



490661
ARTWORK TORTORA RETTIFICATO 30x60
Cod. **76** □



106019
ARTWORK TORTORA RETTIFICATO 10x60
Cod. **83** □

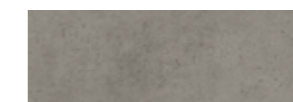

103124
ARTWORK TORTORA RETTIFICATO 10x30
Cod. **77** □



7,50 kg

380281
ARTWORK TORTORA MULTILEVEL SU RETE 19,5x48,8
Cod. **40** ○





050230
ARTWORK TORTORA RETTIFICATO 5x20
Cod. **93** □

IMBALLI • PACKAGES • EMBALLAGES • FORMATE



	SCATOLA • BOX • BOITE • KARTON			PALLET • PALLETS • PALETTS • PALETTE		
	pz	m ^q	kg	box	m ^q	kg
90x90	2	1,62	35,95	20	32,40	745,00
45x90	3	1,22	25,20	32	39,04	830,00
60x60	3	1,08	21,20	40	43,20	875,00
30x60	6	1,08	21,00	40	43,20	865,00
10x60	12	0,72	15,40	60	43,20	950,00
10x30	20	0,60	14,00	60	36,00	850,00
5x20	56	0,56	14,00	60	33,60	850,00

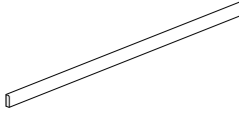
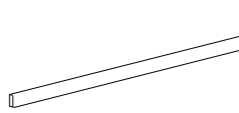





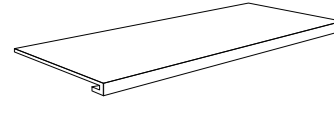



	CASSA • CRATE • CAISSE • HOLZKISTE			CAVALLETTO • A-FRAME • CHEVALET • TRANSPORTGESTELL					
	pz	m ^q	kg	pz	m ^q	kg			
120x280	1	3,36	47,04	20	67,20	1.090,00	44	147,84	2.220,00

Pezzi speciali • Special trims • Pièces spéciales • Formstücke

Battiscopa	20 13,40 kg	14 15,68 kg
	290747 ARTWORK GRIGIO BATTISCOPA 5x60 Cod. 121 △	290751 ARTWORK GRIGIO BATTISCOPA 5x90 Cod. 33 △
	290748 ARTWORK PIOMBO BATTISCOPA 5x60 Cod. 121 △	290752 ARTWORK PIOMBO BATTISCOPA 5x90 Cod. 33 △
	290749 ARTWORK SABBIA BATTISCOPA 5x60 Cod. 121 △	290753 ARTWORK SABBIA BATTISCOPA 5x90 Cod. 33 △
	290746 ARTWORK TORTORA BATTISCOPA 5x60 Cod. 121 △	290750 ARTWORK TORTORA BATTISCOPA 5x90 Cod. 33 △

Gradino	2 10,00 kg	Angolare	2 10,40 kg
	490666 ARTWORK GRIGIO GRADINO 33x60 Cod. 112 ○		490670 ARTWORK GRIGIO ANGOLARE 33x60 Cod. 107 ○
	490667 ARTWORK PIOMBO GRADINO 33x60 Cod. 112 ○		490671 ARTWORK PIOMBO ANGOLARE 33x60 Cod. 107 ○
	490668 ARTWORK SABBIA GRADINO 33x60 Cod. 112 ○		490672 ARTWORK SABBIA ANGOLARE 33x60 Cod. 107 ○
	490665 ARTWORK TORTORA GRADINO 33x60 Cod. 112 ○		490669 ARTWORK TORTORA ANGOLARE 33x60 Cod. 107 ○

Gradino	2 13,50 kg	Angolare	2 14,50 kg
	490674 ARTWORK GRIGIO GRADINO 33x90 Cod. 114 ○		490678 ARTWORK GRIGIO ANGOLARE 33x90 Cod. 110 ○
	490675 ARTWORK PIOMBO GRADINO 33x90 Cod. 114 ○		490679 ARTWORK PIOMBO ANGOLARE 33x90 Cod. 110 ○
	490676 ARTWORK SABBIA GRADINO 33x90 Cod. 114 ○		490680 ARTWORK SABBIA ANGOLARE 33x90 Cod. 110 ○
	490673 ARTWORK TORTORA GRADINO 33x90 Cod. 114 ○		490677 ARTWORK TORTORA ANGOLARE 33x90 Cod. 110 ○

CARATTERISTICHE DI QUALITÀ Quality characteristics Caractéristiques de qualité Qualitätseigenschaften	NORMA Norm Norme Norme	REQUISITO NORMA Required standards Valeur prescrite selon la norme Normvorgabe	RISULTATO Result Résultat Ergebniss
 Assorbimento d'acqua Water absorption of the body Absorption d'eau de support Wasseraufnahme des Scherbens	ISO 10545-3	≤ 0,5	Conforme Conformity Conforme Gemäss
 Resistenza a flessione Breaking strenght Résistance à la flexion Biegefestigkeit	ISO 10545-4	≥ 35 N/mm ²	Conforme Conformity Conforme Gemäss
 Resistenza all'abrasione Abrasion resistance Resistance a l'abrasion Abriebbeständigkeit	ISO 10545-7		PEI V
 Resistenza al gelo Frost resistance Résistance au gel Frostbeständigkeit		Nessun campione deve presentare rotture o alterazioni apprezzabili alla superficie No samples must show ruptures or noticeable surface alteration Aucuns enchantions doit présenter ruptures ou altérations appréciables de la surface Keines der Muster sollte Risse oder sichtbare Fehler der Oberfläche zeigen	Conforme Conformity Conforme Gemäss
 Resistenza all'attacco chimico Chemical resistance Résistance à l'attaque chimique Beständigkeit gegen chemikalien	ISO 10545-13		GA GLA
 Resistenza agli sbalzi termici Thermal shock resistance Resistance aux écarts de température Temperaturwechselbeständigkeit	ISO 10545-5		Conforme Conformity Conforme Gemäss
 Resistenza scivolosità Sliding resistance Resistance au glissement Rutschfestigkeit	DIN 51130 R		R10
 Resistenza scivolosità Sliding resistance Resistance au glissement Rutschfestigkeit	DIN 51097 (A+B+C)		A+B
 Coefficiente d'attrito dinamico Wet dynamic coefficient of friction Coefficient de friction dynamique Reibungskoeffizient Schlupfgrigkeit (in Bewegung)	Bot 3000 E	DCOF ≥ 0,42	> 0,42
 Moderata variazione Moderate variation Variation modérée Mäßige Abweichung			V3

 V1 Aspetto uniforme Uniform appearance Aspect uniforme Einheitliches Aussehen	 V2 Lieve variazione Slight variation Légère variation Geringe Abweichung	 V3 Moderata variazione Moderate variation Variation modérée Mäßige Abweichung	 V4 Forte stonizzazione Substantial variation Effet dénuancé très accentué Akzentuierte Variation
---	--	---	--

PER UNA POSA OTTIMALE DEL PRODOTTO CONSIGLIAMO SEMPRE DI MESCOLARE ALMENO TRE SCATOLE DI MATERIALE.

For the best product laying results, material from at least three boxes should be mixed.

Pour une pose excellente, nous recommandons toujours de mélanger le contenu d'au moins trois boîtes.

Für eine optimale Verlegung des Erzeugnisses empfehlen wir stets, mindestens drei Packungen Material anzumischen.



Tipologia
Type
Typologie
Typ
Gres porcellanato smaltato
Glazed porcelain
Grès cérame emaille
Feinsteinzeug glasiert

Formati
Sizes
Formats
Formate
Esagono 25x22
20x20
5x20

Spessore
Thickness
Épaisseur
Stärke
10 mm

Resistenza scivolosità
Sliding resistance
Resistance au glissement
Rutschfestigkeit
R10

Grado di variazione cromatica
Degree of colour change
Degré de variation chromatique
Grad der Farbabweichung
V2

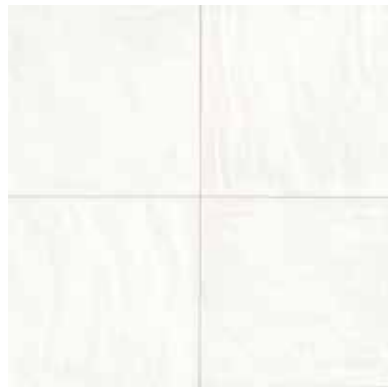

130058
DECO STYLE WHITE GLOSSY RETTIFICATO 20x20
Cod. **81** □



050218
DECO STYLE WHITE GLOSSY RETTIFICATO 5x20
Cod. **103** □



252202
DECO STYLE ESAGONO WHITE GLOSSY NATURALE 25x22
Cod. **85** □



130060
DECO STYLE BEIGE GLOSSY RETTIFICATO 20x20
Cod. **81** □



050220
DECO STYLE BEIGE GLOSSY RETTIFICATO 5x20
Cod. **103** □



252204
DECO STYLE ESAGONO BEIGE GLOSSY NATURALE 25x22
Cod. **85** □

130057
DECO STYLE WHITE MATT RETTIFICATO 20x20
Cod. **81** □

050217
DECO STYLE WHITE MATT RETTIFICATO 5x20
Cod. **103** □

252201
DECO STYLE ESAGONO WHITE MATT NATURALE 25x22
Cod. **85** □

130059
DECO STYLE BEIGE MATT RETTIFICATO 20x20
Cod. **81** □

050219
DECO STYLE BEIGE MATT RETTIFICATO 5x20
Cod. **103** □

252203
DECO STYLE ESAGONO BEIGE MATT NATURALE 25x22
Cod. **85** □

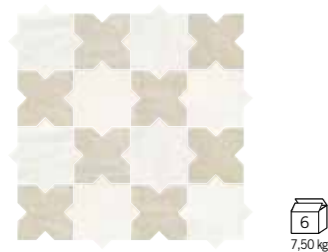

262602
DECO STYLE DECORO HYDRO - MED
WHITE /BEIGE GLOSSY 25,6x25,6
Cod. **69** ○



262601
DECO STYLE DECORO HYDRO - MED
WHITE /GREY GLOSSY 25,6x25,6
Cod. **69** ○



262603
DECO STYLE DECORO HYDRO - MED
WHITE /CHARCOAL GLOSSY 25,6x25,6
Cod. **69** ○



262602
DECO STYLE DECORO HYDRO - MED
WHITE /BEIGE MATT 25,6x25,6
Cod. **69** ○

262605
DECO STYLE DECORO HYDRO - MED
WHITE /BEIGE MATT 25,6x25,6
Cod. **69** ○

262604
DECO STYLE DECORO HYDRO - MED
WHITE /GREY MATT 25,6x25,6
Cod. **69** ○

262606
DECO STYLE DECORO HYDRO - MED
WHITE /CHARCOAL MATT 25,6x25,6
Cod. **69** ○

262605
DECO STYLE DECORO HYDRO - MED
WHITE /BEIGE MATT 25,6x25,6
Cod. **69** ○



041187
DECO STYLE WHITE MOSAICO
GLOSSY 5x5 SU RETE 20x20
Cod. **16** ○



450385
DECO STYLE BULLNOSE
WHITE GLOSSY RETTIFICATO 5x20
Cod. **116** △



380280
DECO STYLE WHITE MATT
LONDON 3x20
Cod. **22** ○

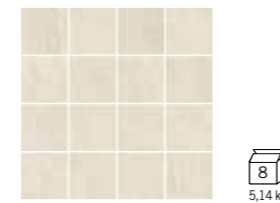

041188
DECO STYLE BEIGE MOSAICO
GLOSSY 5x5 SU RETE 20x20
Cod. **16** ○



450386
DECO STYLE BULLNOSE
BEIGE GLOSSY RETTIFICATO 5x20
Cod. **116** △



380274
DECO STYLE BEIGE MATT
LONDON 3x20
Cod. **22** ○

041191
DECO STYLE WHITE MOSAICO
MATT 5x5 SU RETE 20x20
Cod. **16** ○

450389
DECO STYLE BULLNOSE
WHITE MATT RETTIFICATO 5x20
Cod. **116** △

380279
DECO STYLE WHITE GLOSSY
LONDON 3x20
Cod. **22** ○

041192
DECO STYLE BEIGE MOSAICO
MATT 5x5 SU RETE 20x20
Cod. **16** ○

450390
DECO STYLE BULLNOSE
BEIGE MATT RETTIFICATO 5x20
Cod. **116** △

380273
DECO STYLE BEIGE GLOSSY
LONDON 3x20
Cod. **22** ○

IMBALLI • PACKAGES • EMBALLAGES • FORMATE

	SCATOLA • BOX • BOITE • KARTON			PALLET • PALLETS • PALETTS • PALETTE		
	pz	mq	kg	box	mq	kg
Esagono 25x22	9	0,37	8,50	72	26,64	630,00
20x20	16	0,64	13,70	72	46,08	1.010,00
5x20	56	0,56	12,00	60	33,60	745,00

IMBALLI • PACKAGES • EMBALLAGES • FORMATE

	SCATOLA • BOX • BOITE • KARTON			PALLET • PALLETS • PALETTS • PALETTE		
	pz	mq	kg	box	mq	kg
Esagono 25x22	9	0,37	8,50	72	26,64	630,00
20x20	16	0,64	13,70	72	46,08	1.010,00
5x20	56	0,56	12,00	60	33,60	745,00



130062
DECO STYLE GREY GLOSSY RETTIFICATO 20x20
Cod. **81** □



050222
DECO STYLE GREY GLOSSY RETTIFICATO 5x20
Cod. **103** □



252206
DECO STYLE ESAGONO GREY GLOSSY NATURALE 25x22
Cod. **85** □



130064
DECO STYLE CHARCOAL GLOSSY RETTIFICATO 20x20
Cod. **81** □



050224
DECO STYLE CHARCOAL GLOSSY RETTIFICATO 5x20
Cod. **103** □



252208
DECO STYLE ESAGONO CHARCOAL GLOSSY NATURALE 25x22
Cod. **85** □

130061
DECO STYLE GREY MATT RETTIFICATO 20x20
Cod. **81** □

050221
DECO STYLE GREY MATT RETTIFICATO 5x20
Cod. **103** □

252205
DECO STYLE ESAGONO GREY MATT NATURALE 25x22
Cod. **85** □

130063
DECO STYLE CHARCOAL MATT RETTIFICATO 20x20
Cod. **81** □

050223
DECO STYLE CHARCOAL MATT RETTIFICATO 5x20
Cod. **103** □

252207
DECO STYLE ESAGONO CHARCOAL MATT NATURALE 25x22
Cod. **85** □

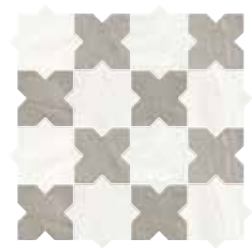

7,50 kg

262601
DECO STYLE DECORO HYDRO - MED
WHITE /GREY GLOSSY 25,6x25,6
Cod. **69** ○

262604
DECO STYLE DECORO HYDRO - MED
WHITE /GREY MATT 25,6x25,6
Cod. **69** ○



7,50 kg

262603
DECO STYLE DECORO HYDRO - MED
WHITE /CHARCOAL GLOSSY 25,6x25,6
Cod. **69** ○

262606
DECO STYLE DECORO HYDRO - MED
WHITE /CHARCOAL MATT 25,6x25,6
Cod. **69** ○

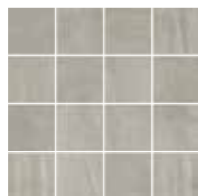

5,14 kg

041189
DECO STYLE GREY MOSAICO
GLOSSY 5x5 SU RETE 20x20
Cod. **16** ○

041193
DECO STYLE GREY MOSAICO
MATT 5x5 SU RETE 20x20
Cod. **16** ○



13,20 kg

450387
DECO STYLE BULLNOSE
GREY GLOSSY RETTIFICATO 5x20
Cod. **116** △

450391
DECO STYLE BULLNOSE
GREY MATT RETTIFICATO 5x20
Cod. **116** △



1,85 kg

380278
DECO STYLE GREY MATT
LONDON 3x20
Cod. **22** ○

380277
DECO STYLE GREY GLOSSY
LONDON 3x20
Cod. **22** ○

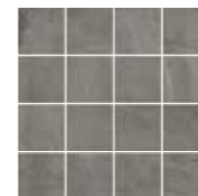

5,14 kg

041190
DECO STYLE CHARCOAL MOSAICO
GLOSSY 5x5 SU RETE 20x20
Cod. **16** ○

041194
DECO STYLE CHARCOAL MOSAICO
MATT 5x5 SU RETE 20x20
Cod. **16** ○



13,20 kg

450388
DECO STYLE BULLNOSE
CHARCOAL GLOSSY RETTIFICATO 5x20
Cod. **116** △

450392
DECO STYLE BULLNOSE
CHARCOAL MATT RETTIFICATO 5x20
Cod. **116** △



1,85 kg

380276
DECO STYLE CHARCOAL MATT
LONDON 3x20
Cod. **22** ○

380275
DECO STYLE CHARCOAL GLOSSY
LONDON 3x20
Cod. **22** ○

IMBALLI • PACKAGES • EMBALLAGES • FORMATE

	SCATOLA • BOX • BOITE • KARTON			PALLET • PALLETS • PALETTS • PALETTE		
	pz	mq	kg	box	mq	kg
Esagono 25x22	9	0,37	8,50	72	26,64	630,00
20x20	16	0,64	13,70	72	46,08	1.010,00
5x20	56	0,56	12,00	60	33,60	745,00

IMBALLI • PACKAGES • EMBALLAGES • FORMATE

	SCATOLA • BOX • BOITE • KARTON			PALLET • PALLETS • PALETTS • PALETTE		
	pz	mq	kg	box	mq	kg
Esagono 25x22	9	0,37	8,50	72	26,64	630,00
20x20	16	0,64	13,70	72	46,08	1.010,00
5x20	56	0,56	12,00	60	33,60	745,00



050226
DECO STYLE BLEND GLOSSY RETTIFICATO 5x20
Cod. **103**  56
12,30 kg

050225
DECO STYLE BLEND MATT RETTIFICATO 5x20
Cod. **103** 



130068
DECO STYLE CEM 1 GLOSSY RETTIFICATO 20x20
Cod. **81**  16
13,50 kg

130065
DECO STYLE CEM 1 MATT RETTIFICATO 20x20
Cod. **81** 



130069
DECO STYLE CEM 2 GLOSSY RETTIFICATO 20x20
Cod. **81**  16
13,50 kg

130066
DECO STYLE CEM 2 MATT RETTIFICATO 20x20
Cod. **81** 













252212
DECO STYLE CEM 3 ESAGONO GLOSSY NATURALE 25x22
Cod. **85**  9
8,50 kg

252209
DECO STYLE CEM 3 ESAGONO MATT NATURALE 25x22
Cod. **85** 





252213
DECO STYLE CEM 4 ESAGONO GLOSSY NATURALE 25x22
Cod. **85**  9
8,50 kg

252210
DECO STYLE CEM 4 ESAGONO MATT NATURALE 25x22
Cod. **85** 

CARATTERISTICHE DI QUALITÀ Quality characteristics Caractéristiques de qualité Qualitätseigenschaften	NORMA Norm Norme Norme	REQUISITO NORMA Required standards Valeur prescrite selon la norme Normvorgabe	RISULTATO Result Résultat Ergebniss
 Assorbimento d'acqua Water absorption of the body Absorption d'eau de support Wasseraufnahme des Scherbens	ISO 10545-3	≤ 0,5	Conforme Conformity Conforme Gemäss
 Resistenza a flessione Breaking strenght Résistance à la flexion Biegefestigkeit	ISO 10545-4	≥ 35 N/mm ²	Conforme Conformity Conforme Gemäss
 Resistenza all'abrasione Abrasion resistance Résistance à l'abrasion Abriebbeständigkeit	ISO 10545-7	Matt	PEI IV
		Glossy	PEI III
 Resistenza al gelo Frost resistance Résistance au gel Frostbeständigkeit	ISO 10545-12	Nessun campione deve presentare rotture o alterazioni apprezzabili alla superficie No samples must show ruptures or noticeable surface alteration Aucuns enchantions doit présenter ruptures ou altérations appréciables de la surface Keines der Muster sollte Risse oder sichtbare Fehler der Oberflaeche zeigen	Conforme Conformity Conforme Gemäss
 Resistenza all'attacco chimico Chemical resistance Résistance à l'attaque chimique Beständigkeit gegen chemikalien	ISO 10545-13		GA GLA
 Resistenza agli sbalzi termici Thermal shock resistance Resistance aux ecarts de température Temperaturwechselbeständigkeit	ISO 10545-5		Conforme Conformity Conforme Gemäss
 Resistenza scivolosità Sliding resistance Resistance au glissement Rutschfestigkeit	DIN 51130 R		R10 Matt
 Coefficiente d'attrito dinamico Wet dynamic coefficient of friction Coefficient de friction dynamique Reibungskoeffizient schlüpfigkeit (in bewegung)	Bot 3000 E	DCOF ≥ 0,42	≥ 0,42 Matt
 Lieve variazione Slight variation Légère variation Geringe Abweichung			V2

V1  Aspetto uniforme
Uniform appearance
Aspect uniforme
Einheitliches Aussehen

V2  Lieve variazione
Slight variation
Légère variation
Geringe Abweichung

V3  Moderata variazione
Moderate variation
Variation modérée
Mäßige Abweichung

V4  Forte stonalizzazione
Substantial variation
Effet dénuancé très accentué
Akzentuierte Variation

PER UNA POSA OTTIMALE DEL PRODOTTO CONSIGLIAMO SEMPRE DI MESCOLARE ALMENO TRE SCATOLE DI MATERIALE.

For the best product laying results, material from at least three boxes should be mixed.

Pour une pose excellente, nous recommandons toujours de mélanger le contenu d'au moins trois boîtes.

Für eine optimale Verlegung des Erzeugnisses empfehlen wir stets, mindestens drei Packungen Material anzumischen.



Tipologia
Type
Typologie
Typ
Gres porcellanato smaltato
Glazed porcelain
Grès cérame emaille
Feinsteinzeug glasiert

Formati
Sizes
Formats
Formate
90x90
45x90
60x60
30x60
30x30
7,5x30
15x15

Spessore
Thickness
Épaisseur
Stärke
10 mm

Resistenza scivolosità
Sliding resistance
Resistance au glissement
Rutschfestigkeit
R10 / A+B+C

Grado di variazione cromatica
Degree of colour change
Degré de variation chromatique
Grad der Farbabweichung
V3



909034
ESSENTIAL TAUPE RETTIFICATO 90x90
Cod. **97** □



459029
ESSENTIAL TAUPE RETTIFICATO 45x90
Cod. **90** □



041069
ESSENTIAL TAUPE
MOSAICO 5x5 SU RETE 30x30
Cod. **24** ○



501139
ESSENTIAL TAUPE MOSAICO
FRAME 2,8x5,8 SU RETE 30x30
Cod. **28** ○



(A)



380257
ESSENTIAL TAUPE LISTELLO
STEEL 7x30
Cod. **25** ○



380261
ESSENTIAL TAUPE
LISTELLO MULTILEVEL 8x30
Cod. **26** ○



310202
ESSENTIAL TAUPE
LONDON 4x30
Cod. **33** ○



606186
ESSENTIAL TAUPE RETTIFICATO 60x60
Cod. **79** □



490581
ESSENTIAL TAUPE RETTIFICATO 30x60
Cod. **76** □



041063
ESSENTIAL TAUPE RETTIFICATO 30x30
Cod. **78** □



753004
ESSENTIAL TAUPE RETTIFICATO 7,5x30
Cod. **81** □



230267
ESSENTIAL TAUPE
RETTIFICATO 15x15
Cod. **80** □

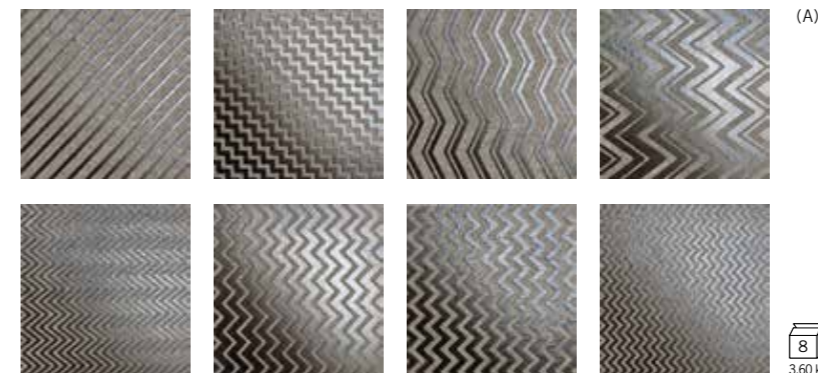

(A)

(A)



230271
ESSENTIAL TAUPE
DECORO STEEL 15x15
Cod. **5** ○

IMBALLI • PACKAGES • EMBALLAGES • FORMATE

	SCATOLA • BOX • BOITE • KARTON			PALLET • PALLETS • PALETTS • PALETTE		
	pz	mq	kg	box	mq	kg
90x90	2	1,62	37,00	20	32,40	760,00
45x90	3	1,22	28,60	20	24,40	590,00
60x60	4	1,44	33,00	30	43,20	1.015,00
30x60	7	1,26	28,00	32	40,32	916,00
30x30	11	0,99	19,00	46	45,54	1.030,00
7,5x30	32	0,72	15,60	68	48,96	1.080,00
15x15	46	1,04	20,20	33	34,16	685,00



909033
ESSENTIAL SAND RETTIFICATO 90x90
Cod. **97** □



459028
ESSENTIAL SAND RETTIFICATO 45x90
Cod. **90** □

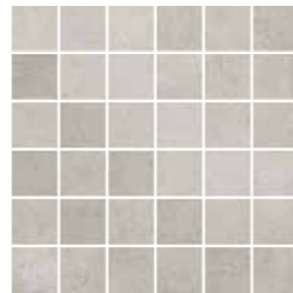

041068
ESSENTIAL SAND
MOSAICO 5x5 SU RETE 30x30
Cod. **24** ○

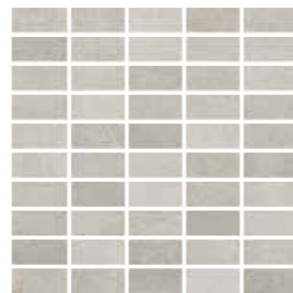

501138
ESSENTIAL SAND MOSAICO
FRAME 2,8x5,8 SU RETE 30x30
Cod. **28** ○



(A)



380256
ESSENTIAL SAND
LISTELLO STEEL 7x30
Cod. **25** ○



380260
ESSENTIAL SAND
LISTELLO MULTILEVEL 8x30
Cod. **26** ○



310201
ESSENTIAL SAND
LONDON 4x30
Cod. **33** ○



606187
ESSENTIAL SAND RETTIFICATO 60x60
Cod. **79** □



490580
ESSENTIAL SAND RETTIFICATO 30x60
Cod. **76** □



041062
ESSENTIAL SAND RETTIFICATO 30x30
Cod. **78** □



753003
ESSENTIAL SAND RETTIFICATO 7,5x30
Cod. **81** □



230266
ESSENTIAL SAND
RETTIFICATO 15x15
Cod. **80** □



(A)



230270
ESSENTIAL SAND
DECORO STEEL 15x15
Cod. **5** ○

IMBALLI • PACKAGES • EMBALLAGES • FORMATE

	SCATOLA • BOX • BOITE • KARTON			PALLET • PALLETS • PALETTS • PALETTE		
	pz	mq	kg	box	mq	kg
90x90	2	1,62	37,00	20	32,40	760,00
45x90	3	1,22	28,60	20	24,40	590,00
60x60	4	1,44	33,00	30	43,20	1.015,00
30x60	7	1,26	28,00	32	40,32	916,00
30x30	11	0,99	19,00	46	45,54	1.030,00
7,5x30	32	0,72	15,60	68	48,96	1.080,00
15x15	46	1,04	20,20	33	34,16	685,00



909032
ESSENTIAL MUD RETTIFICATO 90x90
Cod. **97** □



459027
ESSENTIAL MUD RETTIFICATO 45x90
Cod. **90** □



6
12,30 kg

041067
ESSENTIAL MUD
MOSAICO 5x5 SU RETE 30x30
Cod. **24** ○

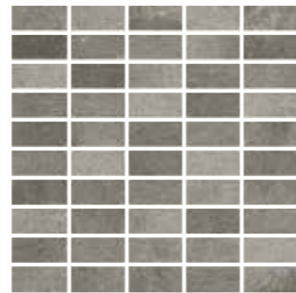

6
12,00 kg

501137
ESSENTIAL MUD MOSAICO
FRAME 2,8x5,8 SU RETE 30x30
Cod. **28** ○



(A)

16
5,70 kg

380255
ESSENTIAL MUD
LISTELLO STEEL 7x30
Cod. **25** ○



10
4,80 kg

380259
ESSENTIAL MUD
LISTELLO MULTILEVEL 8x30
Cod. **26** ○



24
6,48 kg

310200
ESSENTIAL MUD
LONDON 4x30
Cod. **33** ○



606185
ESSENTIAL MUD RETTIFICATO 60x60
Cod. **79** □



490579
ESSENTIAL MUD RETTIFICATO 30x60
Cod. **76** □



041061
ESSENTIAL MUD RETTIFICATO 30x30
Cod. **78** □



753002
ESSENTIAL MUD RETTIFICATO 7,5x30
Cod. **81** □



230265
ESSENTIAL MUD
RETTIFICATO 15x15
Cod. **80** □



(A)

8

3,60 kg

230269
ESSENTIAL MUD
DECORO STEEL 15x15
Cod. **5** ○

IMBALLI • PACKAGES • EMBALLAGES • FORMATE

	SCATOLA • BOX • BOITE • KARTON			PALLET • PALLETS • PALETTS • PALETTE		
	pz	mq	kg	box	mq	kg
90x90	2	1,62	37,00	20	32,40	760,00
45x90	3	1,22	28,60	20	24,40	590,00
60x60	4	1,44	33,00	30	43,20	1.015,00
30x60	7	1,26	28,00	32	40,32	916,00
30x30	11	0,99	19,00	46	45,54	1.030,00
7,5x30	32	0,72	15,60	68	48,96	1.080,00
15x15	46	1,04	20,20	33	34,16	685,00

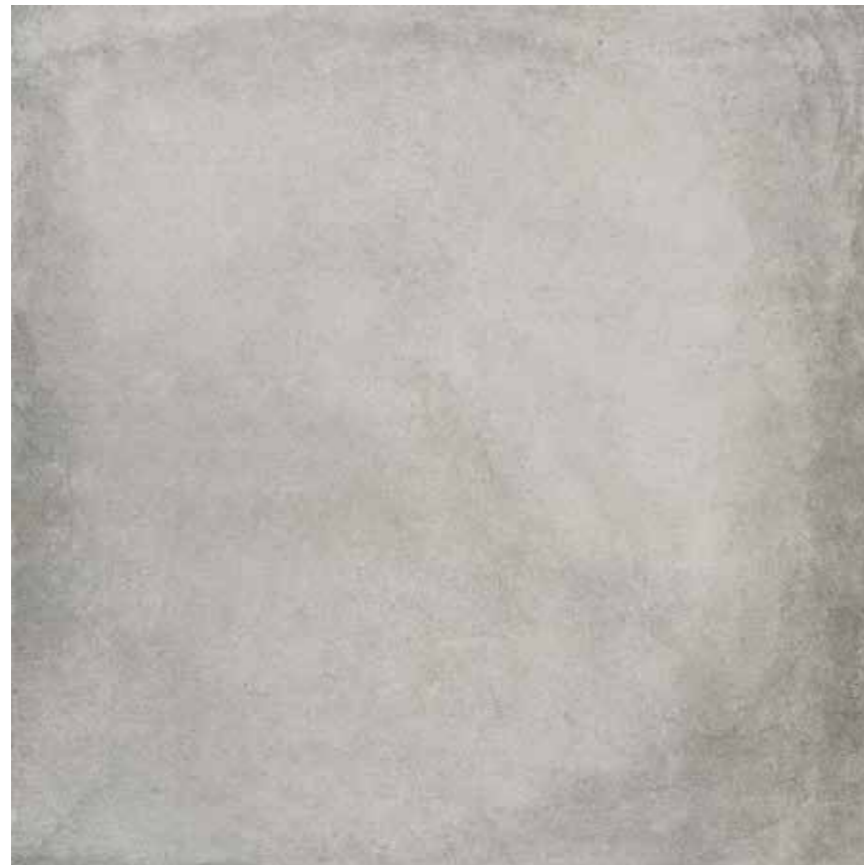

909031
ESSENTIAL GREY RETTIFICATO 90x90
Cod. **97** □



459026
ESSENTIAL GREY RETTIFICATO 45x90
Cod. **90** □



041066
ESSENTIAL GREY
MOSAICO 5x5 SU RETE 30x30
Cod. **24** ○



501136
ESSENTIAL GREY MOSAICO
FRAME 2,8x5,8 SU RETE 30x30
Cod. **28** ○



(A)



380254
ESSENTIAL GREY
LISTELLO STEEL 7x30
Cod. **25** ○



380258
ESSENTIAL GREY
LISTELLO MULTILEVEL 8x30
Cod. **26** ○



310199
ESSENTIAL GREY
LONDON 4x30
Cod. **33** ○



606184
ESSENTIAL GREY RETTIFICATO 60x60
Cod. **79** □



490578
ESSENTIAL GREY RETTIFICATO 30x60
Cod. **76** □



041060
ESSENTIAL GREY RETTIFICATO 30x30
Cod. **78** □



753001
ESSENTIAL GREY RETTIFICATO 7,5x30
Cod. **81** □



(A)

(A)



230268
ESSENTIAL GREY
DECORO STEEL 15x15
Cod. **5** ○

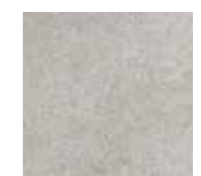

230264
ESSENTIAL GREY
RETTIFICATO 15x15
Cod. **80** □

IMBALLI • PACKAGES • EMBALLAGES • FORMATE

	SCATOLA • BOX • BOITE • KARTON			PALLET • PALLETS • PALETTS • PALETTE		
	pz	m ²	kg	box	m ²	kg
90x90	2	1,62	37,00	20	32,40	760,00
45x90	3	1,22	28,60	20	24,40	590,00
60x60	4	1,44	33,00	30	43,20	1.015,00
30x60	7	1,26	28,00	32	40,32	916,00
30x30	11	0,99	19,00	46	45,54	1.030,00
7,5x30	32	0,72	15,60	68	48,96	1.080,00
15x15	46	1,04	20,20	33	34,16	685,00

Pezzi speciali • Special trims • Pièces spéciales • Formstücke

Battiscopa



11,50 kg



290678
ESSENTIAL TAUPE BATTISCOPA 5x30
Cod. **116** △

290677
ESSENTIAL SAND BATTISCOPA 5x30
Cod. **116** △

290676
ESSENTIAL MUD BATTISCOPA 5x30
Cod. **116** △

290675
ESSENTIAL GREY BATTISCOPA 5x30
Cod. **116** △



13,30 kg

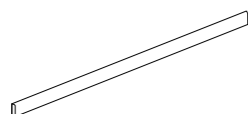

290682
ESSENTIAL TAUPE BATTISCOPA 5x60
Cod. **121** △

290681
ESSENTIAL SAND BATTISCOPA 5x60
Cod. **121** △

290680
ESSENTIAL MUD BATTISCOPA 5x60
Cod. **121** △

290679
ESSENTIAL GREY BATTISCOPA 5x60
Cod. **121** △



15,70 kg

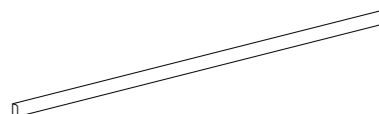

290686
ESSENTIAL TAUPE BATTISCOPA 5x90
Cod. **33** △

290685
ESSENTIAL SAND BATTISCOPA 5x90
Cod. **33** △

290684
ESSENTIAL MUD BATTISCOPA 5x90
Cod. **33** △

290683
ESSENTIAL GREY BATTISCOPA 5x90
Cod. **33** △

Gradino



9,50 kg

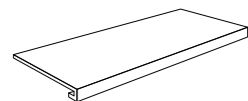

490574
ESSENTIAL TAUPE RETTIFICATO GRADINO 33x60
Cod. **112** ○

490575
ESSENTIAL SAND RETTIFICATO GRADINO 33x60
Cod. **112** ○

490576
ESSENTIAL MUD RETTIFICATO GRADINO 33x60
Cod. **112** ○

490577
ESSENTIAL GREY RETTIFICATO GRADINO 33x60
Cod. **112** ○

Angolare



9,80 kg

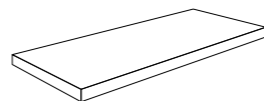

490638
ESSENTIAL TAUPE RETTIFICATO ANGOLARE 33x60
Cod. **107** ○

490639
ESSENTIAL SAND RETTIFICATO ANGOLARE 33x60
Cod. **107** ○

490640
ESSENTIAL MUD RETTIFICATO ANGOLARE 33x60
Cod. **107** ○

490641
ESSENTIAL GREY RETTIFICATO ANGOLARE 33x60
Cod. **107** ○

CARATTERISTICHE DI QUALITÀ Quality characteristics Caractéristiques de qualité Qualitätseigenschaften	NORMA Norm Norme Norme	REQUISITO NORMA Required standards Valeur prescrite selon la norme Normvorgabe	RISULTATO Result Résultat Ergebniss
Assorbimento d'acqua Water absorption of the body Absorption d'eau de support Wasseraufnahme des Scherbens	ISO 10545-3	≤ 0,5	Conforme Conformity Conforme Gemäss
Resistenza a flessione Breaking strenght Résistance à la flexion Biegefestigkeit	ISO 10545-4	≥ 35 N/mm ²	Conforme Conformity Conforme Gemäss
Resistenza all'abrasione Abrasion resistance Résistance a l'abrasion Abriebbeständigkeit	ISO 10545-7	ESSENTIAL DECORO STEEL 15x15	PEI V PEI III
Resistenza al gelo Frost resistance Résistance au gel Frostbeständigkeit		Nessun campione deve presentare rotture o alterazioni apprezzabili alla superficie No samples must show ruptures or noticeable surface alteration Aucuns enchantions doit présenter ruptures ou altérations appréciables de la surface Keines der Muster sollte Risse oder sichtbare Fehler der Oberflaeche zeigen	Conforme Conformity Conforme Gemäss
Resistenza all'attacco chimico Chemical resistance Résistance à l'attaque chimique Beständigkeit gegen chemikalien	ISO 10545-13		GA GLA
Resistenza agli sbalzi termici Thermal shock resistance Résistance aux écarts de température Temperaturwechselbeständigkeit	ISO 10545-5		Conforme Conformity Conforme Gemäss
Resistenza scivolosità Sliding resistance Résistance au glissement Rutschfestigkeit	DIN 51130 R		R10
Resistenza scivolosità Sliding resistance Résistance au glissement Rutschfestigkeit	DIN 51097 (A+B+C)		A+B+C
Coefficiente d'attrito dinamico Wet dynamic coefficient of friction Coefficient de friction dynamique Reibungskoeffizient Schlüpfriqkeit (in Bewegung)	Bot 3000 E	DCOF ≥ 0,42	> 0,42
Moderata variazione Moderate variation Variation modérée Mäßige Abweichung			V3

V1
Aspetto uniforme
Uniform appearance
Aspect uniforme
Einheitliches Aussehen

V2
Lieve variazione
Slight variation
Légère variation
Geringe Abweichung

V3
Moderata variazione
Moderate variation
Variation modérée
Mäßige Abweichung

V4
Forte stonalizzazione
Substantial variation
Effet dénuancé très accentué
Akzentuierte Variation

PER UNA POSA OTTIMALE DEL PRODOTTO CONSIGLIAMO SEMPRE DI MESCOLARE ALMENO TRE SCATOLE DI MATERIALE.

For the best product laying results, material from at least three boxes should be mixed.

Pour une pose excellente, nous recommandons toujours de mélanger le contenu d'au moins trois boîtes.

Für eine optimale Verlegung des Erzeugnisses empfehlen wir stets, mindestens drei Packungen Material anzumischen.

(A)

Il prodotto non è resistente agli acidi. Proteggere la superficie del materiale durante le operazioni di posa. Non usare abrasivi nella pulizia. Utilizzare detergenti neutri. Per nessun motivo saranno accolte contestazioni sul materiale posato.

Le materiel n'est pas résistant à l'attaque chimique. Protéger la surface du material pendant les operations de pose. N'utiliser pas des abrasifs pour nettoyer. Utiliser produits neutrales. On pourra pas accepter réclmations sur le materiel posé.

This product has no chemical resistance. Shelter surface of the material during pose operations. Don't use abrasive products for cleaning. Use only neutral products. For no reasons we'll accept claim on posed material.

Dieser Artikel ist nicht Laugen- und Saeurebestaendig. Die Oberflaeche waehrend der Verlegearbeiten schuetzen. Keine Schleifmittel fuer die Reinigung benutzen. Nur neutrale Reiniger verwenden. Es werden unter keinen Umstaenden Reklamationen NACH der Verlegung akzeptiert.



Tipologia
Type
Typologie
Typ
Gres porcellanato smaltato
Glazed porcelain
Grès cérame emaille
Feinsteinzeug glasiert

Formati
Sizes
Formats
Formate
100x100
60x120
30x120
60x60
30x60
30x30
10x30
20x20

Spessore
Thickness
Épaisseur
Stärke
10 mm

Resistenza scivolosità
Sliding resistance
Resistance au glissement
Rutschfestigkeit
R10 / A+B
R11 / A+B+C

Grado di variazione cromatica
Degree of colour change
Degré de variation chromatique
Grad der Farbabweichung
V2

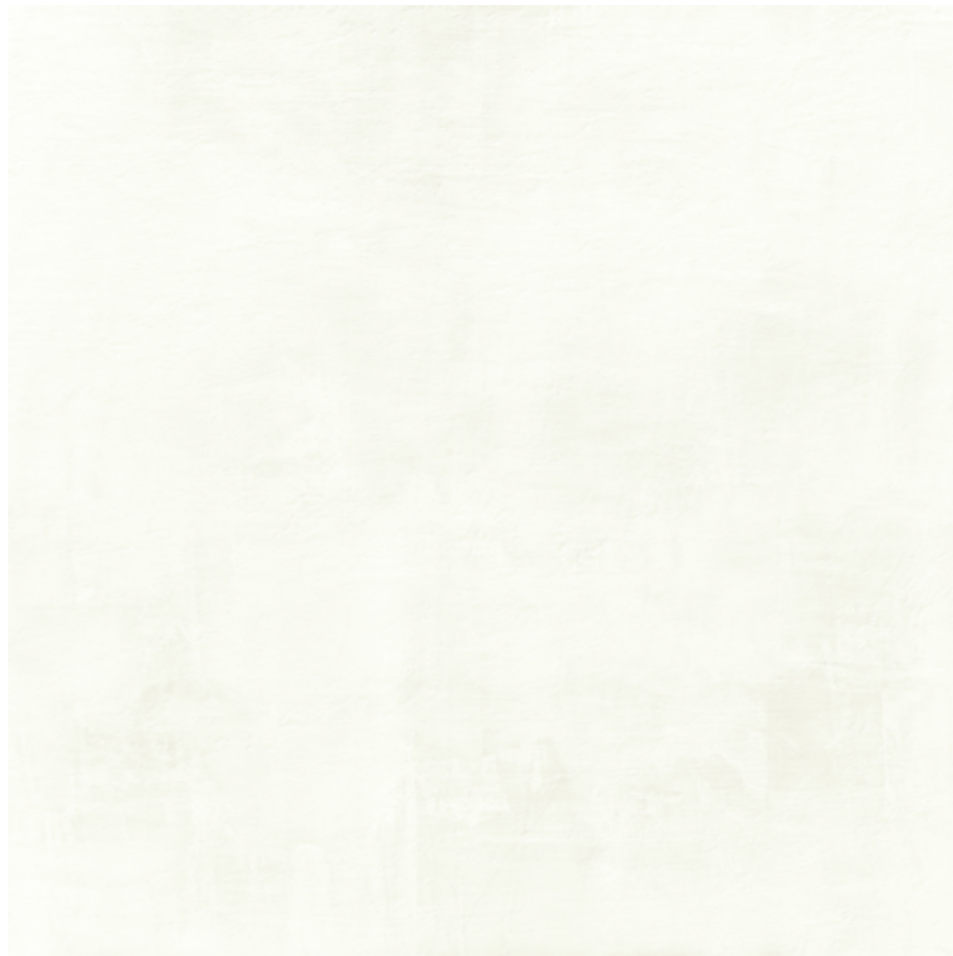

101001
FACTORY WHITE RETTIFICATO 100x100
Cod. **100** □

101008
FACTORY WHITE RETTIFICATO R11 100x100
Cod. **105** □



606197
FACTORY WHITE RETTIFICATO 60x60
Cod. **79** □



490600
FACTORY WHITE RETTIFICATO 30x60
Cod. **76** □

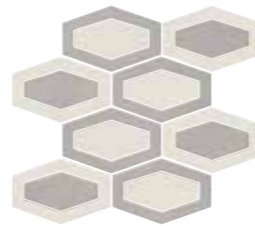

041168
FACTORY WHITE/GREY
MOSAICO CITIZEN 26,1x26,1
Cod. **38** ○

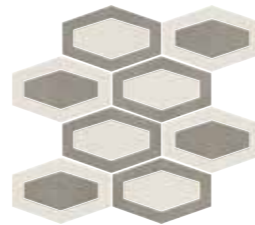

041169
FACTORY WHITE/SMOKE
MOSAICO CITIZEN 26,1x26,1
Cod. **38** ○

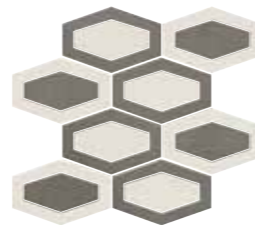

041170
FACTORY WHITE/BLACK
MOSAICO CITIZEN 26,1x26,1
Cod. **38** ○



041107
FACTORY WHITE RETTIFICATO 30x30
Cod. **78** □



130053
FACTORY WHITE RETTIFICATO 20x20
Cod. **120** □



601253
FACTORY WHITE RETTIFICATO 60x120
Cod. **94** □



301248
FACTORY WHITE RETTIFICATO 30x120
Cod. **99** □



103098
FACTORY WHITE RETTIFICATO 10x30 Cod. **77** □

IMBALLI • PACKAGES • EMBALLAGES • FORMATE

	SCATOLA • BOX • BOITE • KARTON			PALLET • PALLETS • PALETTES • PALETTE		
	pz	m ^q	kg	box	m ^q	kg
100x100	1	1,00	23,00	36	36,00	850,00
60x120	2	1,44	32,40	30	43,20	978,00
30x120	3	1,08	26,50	42	45,36	1.133,00
60x60	3	1,08	23,60	40	43,20	965,00
30x60	6	1,08	26,00	40	43,20	960,00
30x30	11	0,99	21,80	46	45,54	1.025,00
10x30	20	0,60	13,00	60	36,00	800,00
20x20	25	1,00	23,00	51	51,00	1.200,00



041115
FACTORY WHITE MOSAICO 5x5
SU RETE 30x30 Cod. **24** ○

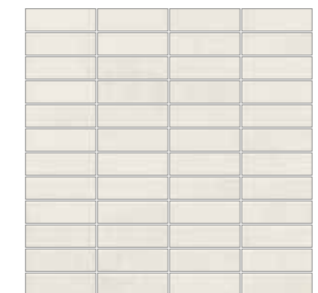

041154
FACTORY WHITE MOSAICO 2,5x7,5
SU RETE 30x30 Cod. **24** ○

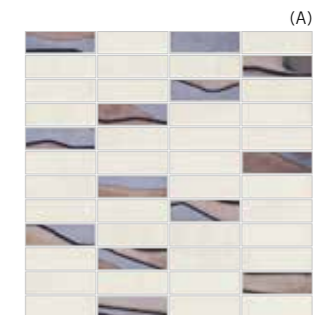

041158
FACTORY WHITE MOSAICO METAL 2,5x7,5
SU RETE 30x30 Cod. **38** ○



380262
FACTORY WHITE LISTELLO METAL 5x30
Cod. **4** ○

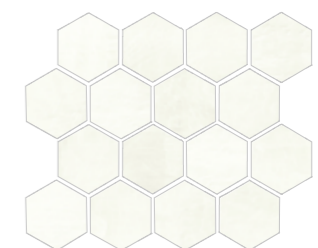

041111
FACTORY WHITE
MOSAICO ESAGONO 26x30
Cod. **128** ○

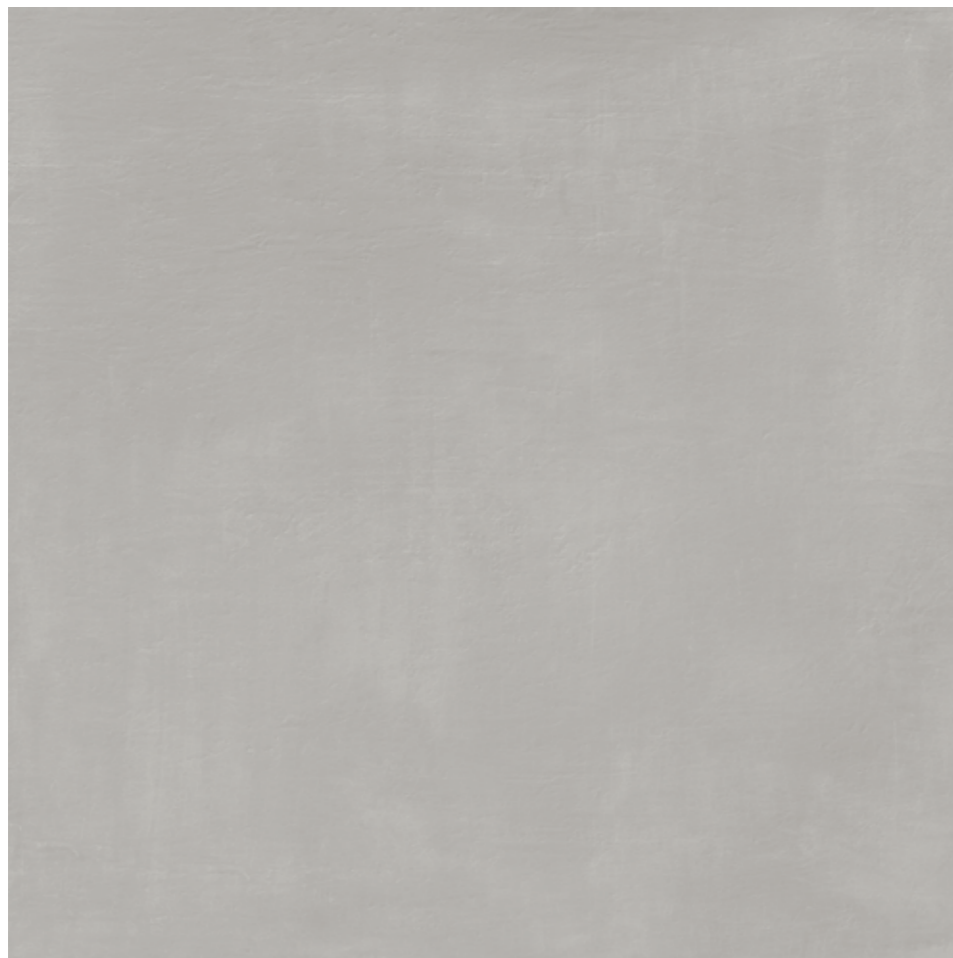

101002
FACTORY GREY RETTIFICATO 100x100
Cod. **100** □

101007
FACTORY GREY RETTIFICATO R11 100x100
Cod. **105** □



606198
FACTORY GREY RETTIFICATO 60x60
Cod. **79** □

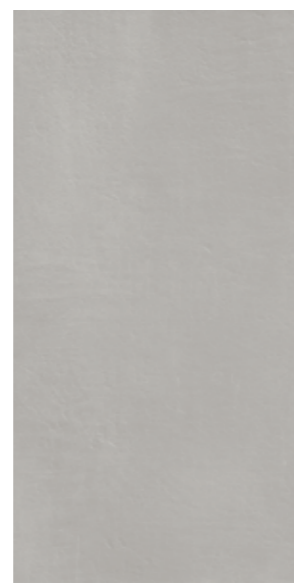

490601
FACTORY GREY RETTIFICATO 30x60
Cod. **76** □

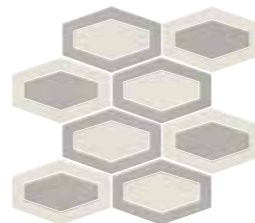

5,20 kg

041168
FACTORY WHITE/GREY
MOSAICO CITIZEN 26,1x26,1
Cod. **38** ○



041108
FACTORY GREY RETTIFICATO 30x30
Cod. **78** □



130054
FACTORY GREY RETTIFICATO 20x20
Cod. **120** □



601254
FACTORY GREY RETTIFICATO 60x120
Cod. **94** □

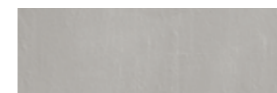

103099
FACTORY GREY RETTIFICATO 10x30 Cod. **77** □



301249
FACTORY GREY RETTIFICATO 30x120
Cod. **99** □

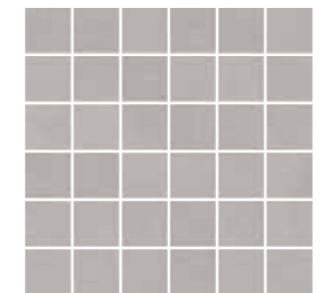

6,40 kg

041116
FACTORY GREY MOSAICO 5x5
SU RETE 30x30 Cod. **24** ○

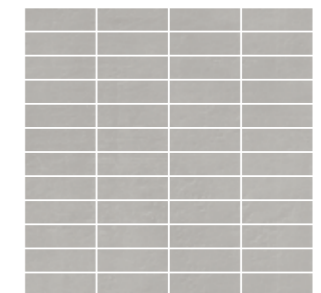

6,40 kg

041155
FACTORY GREY MOSAICO 2,5x7,5
SU RETE 30x30 Cod. **24** ○

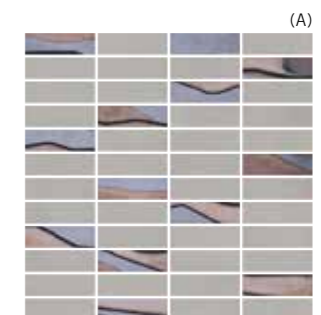

(A)



6,40 kg

041159
FACTORY GREY MOSAICO METAL 2,5x7,5
SU RETE 30x30 Cod. **38** ○



(A)



7,30 kg

380263
FACTORY GREY LISTELLO METAL 5x30
Cod. **4** ○



6,40 kg

041112
FACTORY GREY
MOSAICO ESAGONO 26x30
Cod. **128** ○

IMBALLI • PACKAGES • EMBALLAGES • FORMATE

	SCATOLA • BOX • BOITE • KARTON			PALLET • PALLETS • PALETTS • PALETTE		
	pz	m ^q	kg	box	m ^q	kg
100x100	1	1,00	23,00	36	36,00	850,00
60x120	2	1,44	32,40	30	43,20	978,00
30x120	3	1,08	26,50	42	45,36	1.133,00
60x60	3	1,08	23,60	40	43,20	965,00
30x60	6	1,08	26,00	40	43,20	960,00
30x30	11	0,99	21,80	46	45,54	1.025,00
10x30	20	0,60	13,00	60	36,00	800,00
20x20	25	1,00	23,00	51	51,00	1.200,00

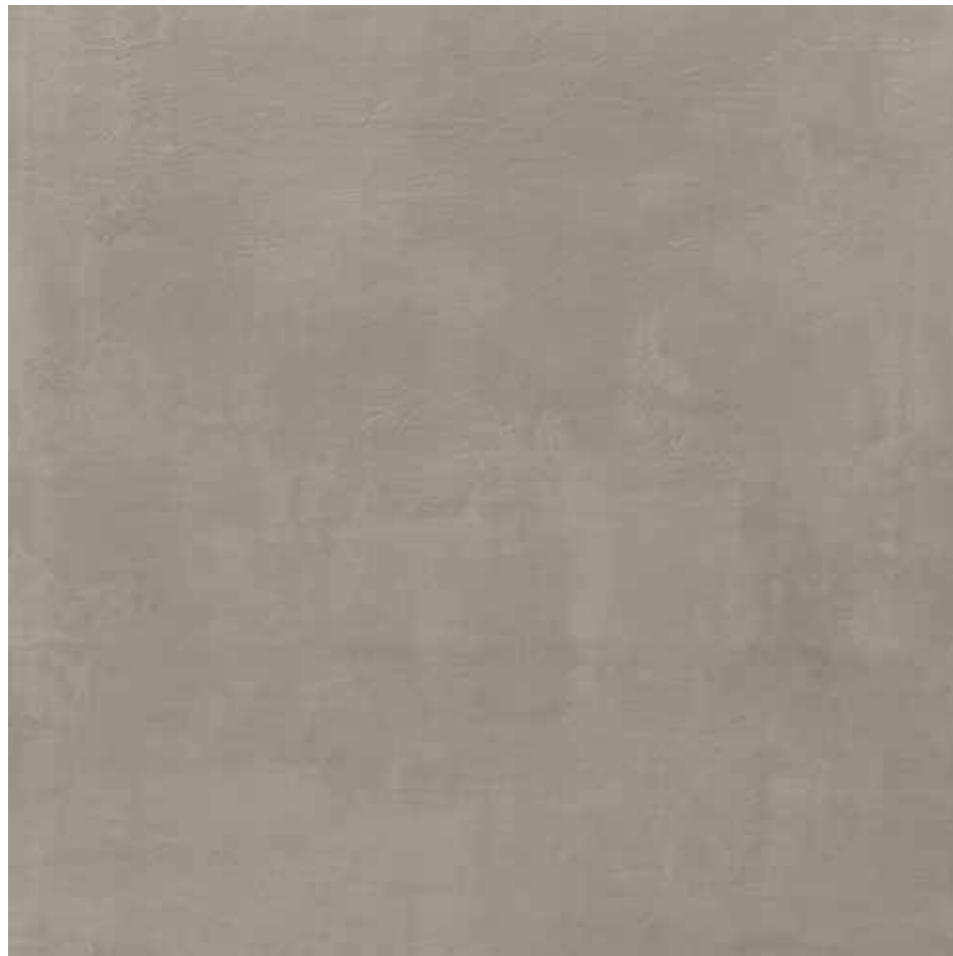

101003
FACTORY SMOKE RETTIFICATO 100x100
Cod. **100** □

101005
FACTORY SMOKE RETTIFICATO **R11** 100x100
Cod. **105** □



606199
FACTORY SMOKE RETTIFICATO 60x60
Cod. **79** □



490602
FACTORY SMOKE RETTIFICATO 30x60
Cod. **76** □

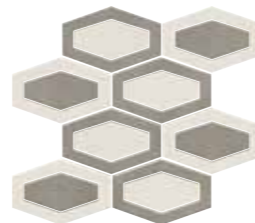

6
5,20 kg

041169
FACTORY WHITE/SMOKE
MOSAICO CITIZEN 26,1x26,1
Cod. **38** ○



041109
FACTORY SMOKE RETTIFICATO 30x30
Cod. **78** □



130055
FACTORY SMOKE RETTIFICATO 20x20
Cod. **120** □



601255
FACTORY SMOKE RETTIFICATO 60x120
Cod. **94** □

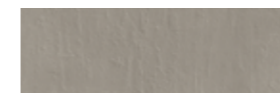

103100
FACTORY SMOKE RETTIFICATO 10x30 Cod. **77** □



301250
FACTORY SMOKE RETTIFICATO 30x120
Cod. **99** □

IMBALLI • PACKAGES • EMBALLAGES • FORMATE

	SCATOLA • BOX • BOITE • KARTON			PALLET • PALLETS • PALETTS • PALETTE		
	pz	m ^q	kg	box	m ^q	kg
100x100	1	1,00	23,00	36	36,00	850,00
60x120	2	1,44	32,40	30	43,20	978,00
30x120	3	1,08	26,50	42	45,36	1.133,00
60x60	3	1,08	23,60	40	43,20	965,00
30x60	6	1,08	26,00	40	43,20	960,00
30x30	11	0,99	21,80	46	45,54	1.025,00
10x30	20	0,60	13,00	60	36,00	800,00
20x20	25	1,00	23,00	51	51,00	1.200,00

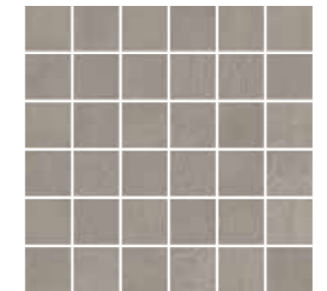

6
6,40 kg

041117
FACTORY SMOKE MOSAICO 5x5
SU RETE 30x30 Cod. **24** ○

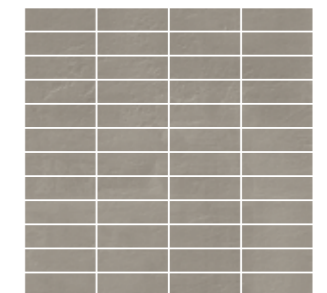

6
6,40 kg

041156
FACTORY SMOKE MOSAICO 2,5x7,5
SU RETE 30x30 Cod. **24** ○

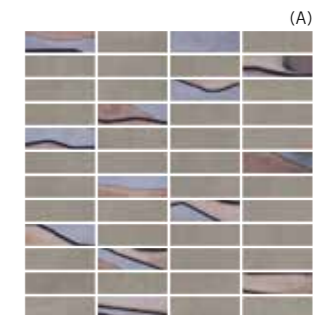

6
6,40 kg

041160
FACTORY SMOKE MOSAICO METAL 2,5x7,5
SU RETE 30x30 Cod. **38** ○



22
7,30 kg

380264
FACTORY SMOKE LISTELLO METAL 5x30
Cod. **4** ○



6
6,40 kg

041113
FACTORY SMOKE
MOSAICO ESAGONO 26x30
Cod. **128** ○

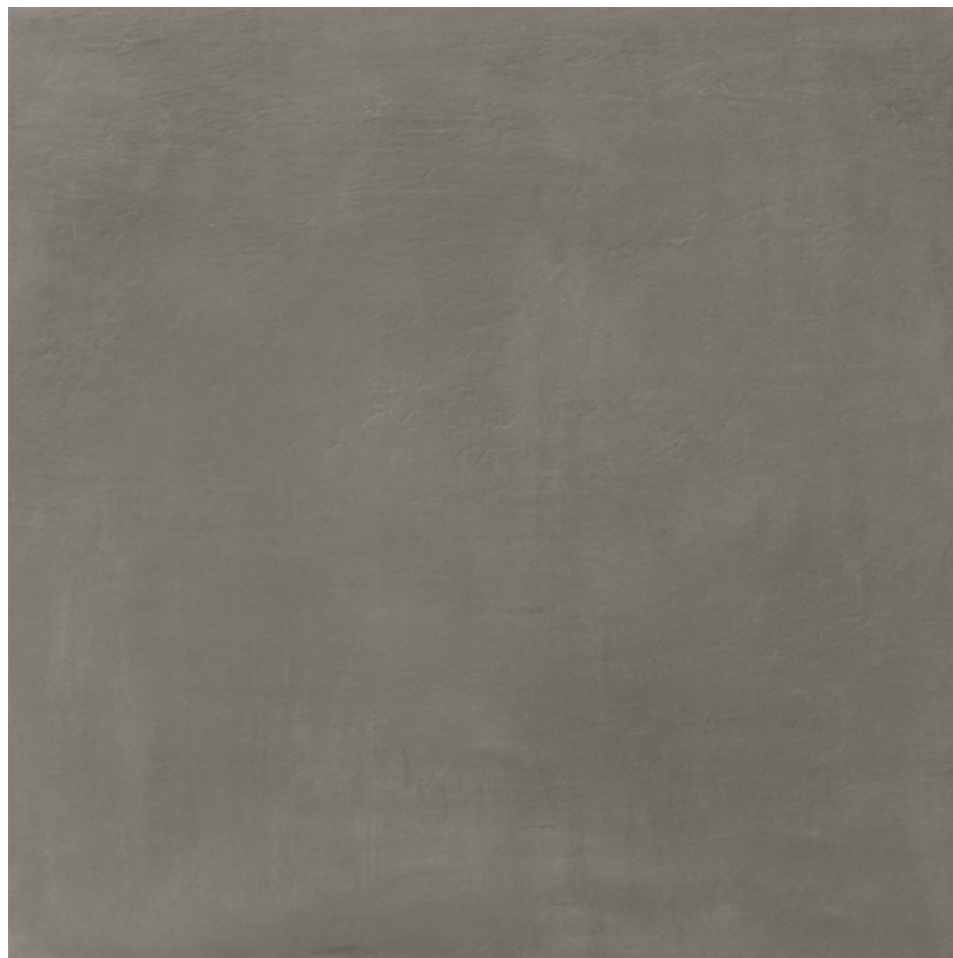

101004
FACTORY BLACK RETTIFICATO 100x100
Cod. **100** □

101006
FACTORY BLACK RETTIFICATO R11 100x100
Cod. **105** □



606200
FACTORY BLACK RETTIFICATO 60x60
Cod. **79** □



490603
FACTORY BLACK RETTIFICATO 30x60
Cod. **76** □

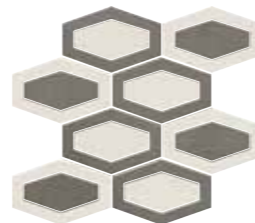

041170
FACTORY WHITE/BLACK
MOSAICO CITIZEN 26,1x26,1
Cod. **38** ○



041110
FACTORY BLACK RETTIFICATO 30x30
Cod. **78** □



130056
FACTORY BLACK RETTIFICATO 20x20
Cod. **120** □



601256
FACTORY BLACK RETTIFICATO 60x120
Cod. **94** □



103101
FACTORY BLACK RETTIFICATO 10x30 Cod. **77** □



301251
FACTORY BLACK RETTIFICATO 30x120
Cod. **99** □

IMBALLI • PACKAGES • EMBALLAGES • FORMATE

	SCATOLA • BOX • BOITE • KARTON			PALLET • PALLETS • PALETTS • PALETTE		
	pz	m ^q	kg	box	m ^q	kg
100x100	1	1,00	23,00	36	36,00	850,00
60x120	2	1,44	32,40	30	43,20	978,00
30x120	3	1,08	26,50	42	45,36	1.133,00
60x60	3	1,08	23,60	40	43,20	965,00
30x60	6	1,08	26,00	40	43,20	960,00
30x30	11	0,99	21,80	46	45,54	1.025,00
10x30	20	0,60	13,00	60	36,00	800,00
20x20	25	1,00	23,00	51	51,00	1.200,00

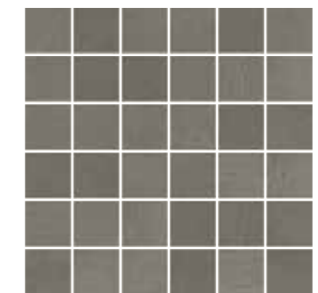

041118
FACTORY BLACK MOSAICO 5x5
SU RETE 30x30 Cod. **24** ○

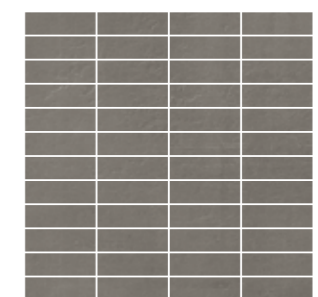

041157
FACTORY BLACK MOSAICO 2,5x7,5
SU RETE 30x30 Cod. **24** ○

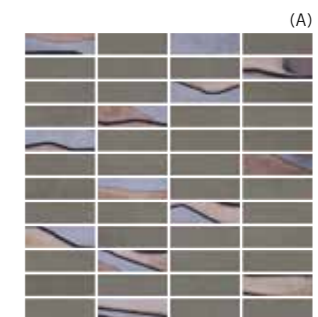

041161
FACTORY BLACK MOSAICO METAL 2,5x7,5
SU RETE 30x30 Cod. **38** ○



380265
FACTORY BLACK LISTELLO METAL 5x30
Cod. **4** ○



041114
FACTORY BLACK
MOSAICO ESAGONO 26x30
Cod. **128** ○

Pezzi speciali • Special trims • Pièces spéciales • Formstücke

Battiscopa



11,60 kg



12,00 kg

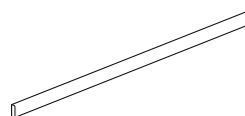

290715
FACTORY WHITE
BATTISCOPA 5x60
Cod. **121** △

290716
FACTORY GREY
BATTISCOPA 5x60
Cod. **121** △

290717
FACTORY SMOKE
BATTISCOPA 5x60
Cod. **121** △

290718
FACTORY BLACK
BATTISCOPA 5x60
Cod. **121** △

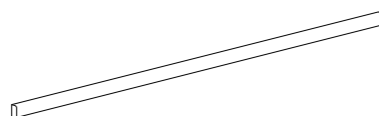

290719
FACTORY WHITE
BATTISCOPA 5x100
Cod. **33** △

290720
FACTORY GREY
BATTISCOPA 5x100
Cod. **33** △

290721
FACTORY SMOKE
BATTISCOPA 5x100
Cod. **33** △

290722
FACTORY BLACK
BATTISCOPA 5x100
Cod. **33** △

Gradino



29,40 kg

Angolare



10,00 kg

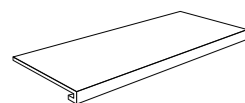

490618
FACTORY WHITE
GRADINO 33x60
Cod. **112** ○

490616
FACTORY GREY
GRADINO 33x60
Cod. **112** ○

490617
FACTORY SMOKE
GRADINO 33x60
Cod. **112** ○

490615
FACTORY BLACK
GRADINO 33x60
Cod. **112** ○

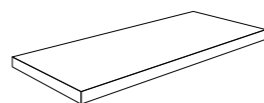

490626
FACTORY WHITE
ANGOLARE 33x60
Cod. **107** ○

490624
FACTORY GREY
ANGOLARE 33x60
Cod. **107** ○

490625
FACTORY SMOKE
ANGOLARE 33x60
Cod. **107** ○

490623
FACTORY BLACK
ANGOLARE 33x60
Cod. **107** ○



17,28 kg



20,00 kg

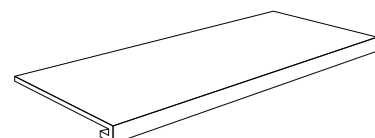

490622
FACTORY WHITE
GRADINO 33x120
Cod. **114** ○

490620
FACTORY GREY
GRADINO 33x120
Cod. **114** ○

490621
FACTORY SMOKE
GRADINO 33x120
Cod. **114** ○

490619
FACTORY BLACK
GRADINO 33x120
Cod. **114** ○

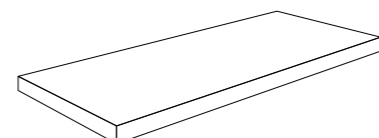

490630
FACTORY WHITE
ANGOLARE 33x120
Cod. **110** ○

490628
FACTORY GREY
ANGOLARE 33x120
Cod. **110** ○

490629
FACTORY SMOKE
ANGOLARE 33x120
Cod. **110** ○

490627
FACTORY BLACK
ANGOLARE 33x120
Cod. **110** ○

CARATTERISTICHE DI QUALITÀ Quality characteristics Caractéristiques de qualité Qualitätseigenschaften	NORMA Norm Norme Norme	REQUISITO NORMA Required standards Valeur prescrite selon la norme Normvorgabe	RISULTATO Result Résultat Ergebniss
Assorbimento d'acqua Water absorption of the body Absorption d'eau de support Wasseraufnahme des Scherbens	ISO 10545-3	≤ 0,5	Conforme Conformity Conforme Gemäss
Resistenza a flessione Breaking strenght Résistance à la flexion Biegefestigkeit	ISO 10545-4	≥ 35 N/mm ²	Conforme Conformity Conforme Gemäss
Resistenza all'abrasione Abrasion resistance Resistance a l'abrasion Abriebbeständigkeit	ISO 10545-7		PEI V
Resistenza al gelo Frost resistance Résistance au gel Frostbeständigkeit	ISO 10545-12	Nessun campione deve presentare rotture o alterazioni apprezzabili alla superficie No samples must show ruptures or noticeable surface alteration Aucuns enchantions doit présenter ruptures ou altérations appréciables de la surface Keines der Muster sollte Risse oder sichtbare Fehler der Oberfläche zeigen	Conforme Conformity Conforme Gemäss
Resistenza all'attacco chimico Chemical resistance Résistance à l'attaque chimique Beständigkeit gegen chemikalien	ISO 10545-13		GA GLA
Resistenza agli sbalzi termici Thermal shock resistance Resistance aux écarts de température Temperaturwechselbeständigkeit	ISO 10545-5		Conforme Conformity Conforme Gemäss
Resistenza scivolosità Sliding resistance Resistance au glissement Rutschfestigkeit	DIN 51130 R	Factory Rettificato	R10
		Factory 100x100 R11	R11
Resistenza scivolosità Sliding resistance Resistance au glissement Rutschfestigkeit	DIN 51097 (A+B+C)	Factory Rettificato	A+B
		Factory 100x100 R11	A+B+C
Coefficiente d'attrito dinamico Wet dynamic coefficient of friction Coefficient de friction dynamique Reibungskoeffizient Schlupfgrigkeit (in Bewegung)	Bot 3000 E	DCOF ≥ 0,42	> 0,42
Lieve variazione Slight variation Légère variation Geringe Abweichung			V2

V1
Aspetto uniforme
Uniform appearance
Aspect uniforme
Einheitliches Aussehen

V2
Lieve variazione
Slight variation
Légère variation
Geringe Abweichung

V3
Moderata variazione
Moderate variation
Variation modérée
Mäßige Abweichung

V4
Forte stonalizzazione
Substantial variation
Effet dénuancé très accentué
Akzentuierte Variation

PER UNA POSA OTTIMALE DEL PRODOTTO CONSIGLIAMO SEMPRE DI MESCOLARE ALMENO TRE SCATOLE DI MATERIALE.

For the best product laying results, material from at least three boxes should be mixed.

Pour une pose excellente, nous recommandons toujours de mélanger le contenu d'au moins trois boîtes.

Für eine optimale Verlegung des Erzeugnisses empfehlen wir stets, mindestens drei Packungen Material anzumischen.

(A)

Il prodotto non è resistente agli acidi. Proteggere la superficie del materiale durante le operazioni di posa.

Non usare abrasivi nella pulizia. Utilizzare detergenti neutri. Per nessun motivo saranno accolte contestazioni sul materiale posato.

Le materiel n'est pas résistant à l'attaque chimique. Protéger la surface du materiel pendant les operations de pose.

N'utiliser pas des abrasifs pour nettoyer. Utiliser produits neutres. On pourra pas accepter réclamations sur le materiel posé.

This product has no chemical resistance. Shelter surface of the material during pose operations.

Don't use abrasive products for cleaning. Use only neutral products. For no reasons we'll accept claim on posed material.

Dieser Artikel ist nicht Laugen- und Säurebeständig. Die Oberfläche während der Verlegearbeiten schuetzen. Keine Schleifmittel fuer die Reinigung benutzen. Nur neutrale Reiniger verwenden. Es werden unter keinen Umstaenden Reklamationen NACH der Verlegung akzeptiert.



Tipologia
Type
Typologie
Typ
Gres porcellanato smaltato
Glazed porcelain
Grès cérame émaillé
Feinsteinzeug glasiert

Formati
Sizes
Formats
Formate
60x60
40x60 + 20x60
30x60

Spessore
Thickness
Épaisseur
Stärke
10 mm

Resistenza scivolosità
Sliding resistance
Resistance au glissement
Rutschfestigkeit
R10 / A+B+C

Grado di variazione cromatica
Degree of colour change
Degré de variation chromatique
Grad der Farbabweichung
V4



606226
FOSSIL RETTIFICATO 60x60
Cod. **79** □



490689
FOSSIL RETTIFICATO 30x60
Cod. **76** □



406052
MIX BOX FOSSIL RETTIFICATO 40x60 + 20x60
Cod. **89** □



041296
FOSSIL MOSAICO 5x5
SU RETE 30x30
Cod. **24** ○

6
11,30 kg

IMBALLI • PACKAGES • EMBALLAGES • FORMATE

	SCATOLA • BOX • BOITE • KARTON			PALLET • PALLETS • PALETTS • PALETTE		
	pz	mq	kg	box	mq	kg
60x60	3	1,08	23,99	40	43,20	960,00
30x60	6	1,08	23,99	40	43,20	960,00
MIX BOX (40x60 + 20x60)	8 (4+4)	1,44	28,00	22	31,68	650,00

Battiscopa  9,00 kg

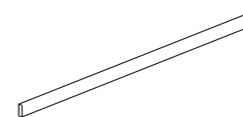

290782
FOSSIL BATTISCOPA 5x60
Cod. **121** △

Gradino  10,00 kg

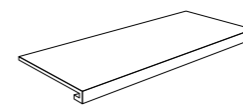





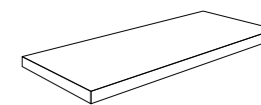





490711
FOSSIL GRADINO 33x60
Cod. **112** ○

Angolare  11,00 kg





490712
FOSSIL ANGOLARE 33x60
Cod. **107** ○

	CARATTERISTICHE DI QUALITÀ Quality characteristics Caractéristiques de qualité Qualitätseigenschaften	NORMA Norm Norme Norme	REQUISITO NORMA Required standards Valeur prescrite selon la norme Normvorgabe	RISULTATO Result Résultat Ergebniss
	Assorbimento d'acqua Water absorption of the body Absorption d'eau de support Wasseraufnahme des Scherbens	ISO 10545-3	≤ 0,5	Conforme Conformity Conforme Gemäss
	Resistenza a flessione Breaking strenght Résistance à la flexion Biegefestigkeit	ISO 10545-4	≥ 35 N/mm ²	Conforme Conformity Conforme Gemäss
	Resistenza all'abrasione Abrasion resistance Résistance à l'abrasion Abriebbeständigkeit	ISO 10545-7		PEI V
	Resistenza al gelo Frost resistance Résistance au gel Frostbeständigkeit	ISO 10545-12	Nessun campione deve presentare rotture o alterazioni apprezzabili alla superficie No samples must show ruptures or noticeable surface alteration Aucuns enchantions doit présenter ruptures ou altérations appréciables de la surface Keines der Muster sollte sehenswerte Aenderungen nach Behandlung mit Chemikalien zeigen	Conforme Conformity Conforme Gemäss
	Resistenza all'attacco chimico Chemical resistance Résistance à l'attaque chimique Beständigkeit gegen chemikalien	ISO 10545-13	Nessun campione deve presentare alterazioni visibili all'attacco chimico No samples must show visible signs of chemical attack Aucuns enchantions doit présenter des altérations visibles à l'attaque chimique Keines der Muster sollte sehenswerte Aenderungen nach Behandlung mit Chemikalien zeigen	Conforme Conformity Conforme Gemäss
	Resistenza agli sbalzi termici Thermal shock resistance Résistance aux écarts de température Temperaturwechselbeständigkeit	ISO 10545-5		Conforme Conformity Conforme Gemäss
	Resistenza scivolosità Sliding resistance Résistance au glissement Rutschfestigkeit	DIN 51130 R		R10
	Resistenza scivolosità Sliding resistance Résistance au glissement Rutschfestigkeit	DIN 51097 (A+B+C)		A+B+C
	Coefficiente d'attrito dinamico Wet dynamic coefficient of friction Coefficient de friction dynamique Reibungskoeffizient Schlüpfirigkeit (in Bewegung)	Bot 3000 E	DCOF ≥ 0,42	> 0,42
	Forte stonalizzazione Substantial variation Effet dénuancé très accentué Akzentuierte Variation			V4

 **V1**
Aspetto uniforme
Uniform appearance
Aspect uniforme
Einheitliches Aussehen

 **V2**
Lieve variazione
Slight variation
Légère variation
Geringe Abweichung

 **V3**
Moderata variazione
Moderate variation
Variation modérée
Mäßige Abweichung

 **V4**
Forte stonalizzazione
Substantial variation
Effet dénuancé très accentué
Akzentuierte Variation

PER UNA POSA OTTIMALE DEL PRODOTTO CONSIGLIAMO SEMPRE DI MESCOLARE ALMENO TRE SCATOLE DI MATERIALE.
For the best product laying results, material from at least three boxes should be mixed.

Pour une pose excellente, nous recommandons toujours de mélanger le contenu d'au moins trois boîtes.

Für eine optimale Verlegung des Erzeugnisses empfehlen wir stets, mindestens drei Packungen Material anzumischen.



Tipologia
Type
Typologie
Typ
Gres porcellanato smaltato
Glazed porcelain
Grès cérame émaillé
Feinsteinzeug glasiert

Formati
Sizes
Formats
Formate
90x90
45x90
60x60
30x60
30x30
10x30

Spessore
Thickness
Épaisseur
Stärke
10 mm

Resistenza scivolosità
Sliding resistance
Resistance au glissement
Rutschfestigkeit
R10 / A+B

Grado di variazione cromatica
Degree of colour change
Degré de variation chromatique
Grad der Farbabweichung
V3



909016
FUSION ANTRACITE RETTIFICATO 90x90
Cod. **97** □



459021
FUSION ANTRACITE RETTIFICATO 45x90
Cod. **90** □

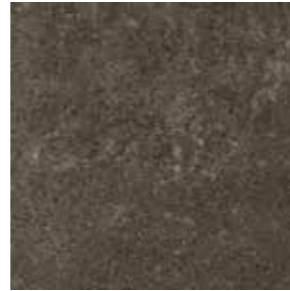

040941
FUSION ANTRACITE RETTIFICATO 30x30
Cod. **78** □



103073
FUSION ANTRACITE RETTIFICATO 10x30
Cod. **77** □



040958
FUSION MOSAICO ARABESQUE BLEND 20x31
Cod. **38** ○

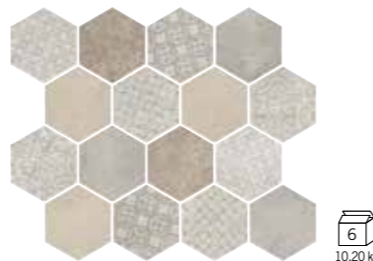

040957
FUSION DECO ESAGONO BLEND 26x30
Cod. **53** ○



606148
FUSION ANTRACITE RETTIFICATO 60x60
Cod. **79** □



490449
FUSION ANTRACITE RETTIFICATO 30x60
Cod. **76** □

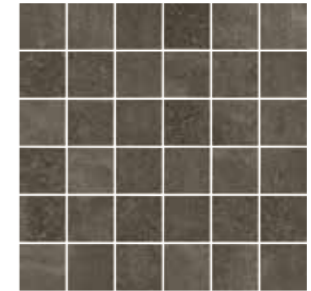

040946
FUSION ANTRACITE MOSAICO
5x5 SU RETE 30x30
Cod. **24** ○



12,30 kg



040951
FUSION ANTRACITE FRAME
2,8x5,8 SU RETE 30x30
Cod. **28** ○



12,00 kg

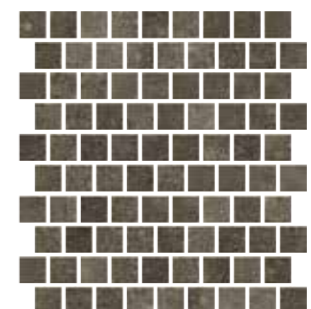

040959
FUSION ANTRACITE MOSAICO
MURETTO 3x3 SU RETE 30x33
Cod. **132** ○



18,50 kg



040956
FUSION ANTRACITE MULTILEVEL
7,5x7,5 SU RETE 30x30
Cod. **43** ○



11,20 kg

IMBALLI • PACKAGES • EMBALLAGES • FORMATE

	SCATOLA • BOX • BOITE • KARTON			PALLET • PALLETS • PALETTS • PALETTE		
	pz	m ^q	kg	box	m ^q	kg
90x90	2	1,62	37,00	18	29,16	690,00
45x90	3	1,22	28,00	32	39,04	894,00
60x60	3	1,08	23,99	40	43,20	960,00
30x60	6	1,08	23,99	40	43,20	960,00
30x30	11	0,99	23,20	46	45,54	1.090,00
10x30	20	0,60	14,00	60	36,00	870,00



909017
FUSION BEIGE RETTIFICATO 90x90
Cod. **97** □



459019
FUSION BEIGE RETTIFICATO 45x90
Cod. **90** □



040939
FUSION BEIGE RETTIFICATO 30x30
Cod. **78** □

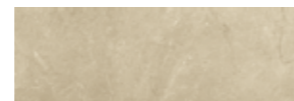

103071
FUSION BEIGE RETTIFICATO 10x30
Cod. **77** □



040958
FUSION MOSAICO ARABESQUE BLEND 20x31
Cod. **38** ○

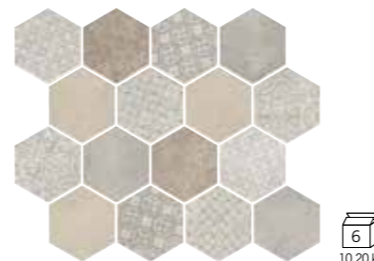

040957
FUSION DECO ESAGONO BLEND 26x30
Cod. **53** ○



380212
FUSION BEIGE LONDON 5X30
Cod. **33** ○



606149
FUSION BEIGE RETTIFICATO 60x60
Cod. **79** □



490450
FUSION BEIGE RETTIFICATO 30x60
Cod. **76** □



040944
FUSION BEIGE MOSAICO
5x5 SU RETE 30x30
Cod. **24** ○



12,30 kg



040949
FUSION BEIGE FRAME
2,8x5,8 SU RETE 30x30
Cod. **28** ○



12,00 kg

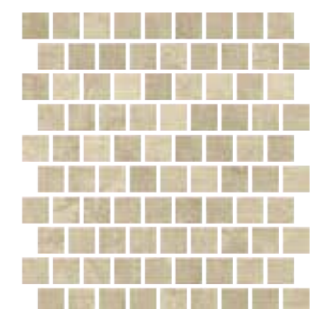

040960
FUSION BEIGE MOSAICO
MURETTO 3x3 SU RETE 30x33
Cod. **132** ○



18,50 kg



040954
FUSION BEIGE MULTILEVEL
7,5x7,5 SU RETE 30x30
Cod. **43** ○



11,20 kg

IMBALLI • PACKAGES • EMBALLAGES • FORMATE

	SCATOLA • BOX • BOITE • KARTON			PALLET • PALLETS • PALETTS • PALETTE		
	pz	mq	kg	box	mq	kg
90x90	2	1,62	37,00	18	29,16	690,00
45x90	3	1,22	28,00	32	39,04	894,00
60x60	3	1,08	23,99	40	43,20	960,00
30x60	6	1,08	23,99	40	43,20	960,00
30x30	11	0,99	23,20	46	45,54	1.090,00
10x30	20	0,60	14,00	60	36,00	870,00



909018
FUSION BIANCO RETTIFICATO 90x90
Cod. **97** □



459020
FUSION BIANCO RETTIFICATO 45x90
Cod. **90** □



040940
FUSION BIANCO RETTIFICATO 30x30
Cod. **78** □



103072
FUSION BIANCO RETTIFICATO 10x30
Cod. **77** □



040958
FUSION MOSAICO ARABESQUE BLEND 20x31
Cod. **38** ○

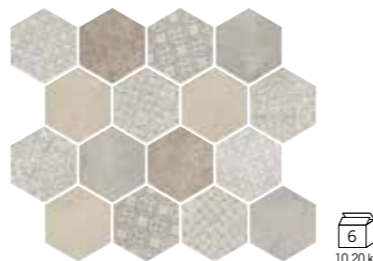

040957
FUSION DECO ESAGONO BLEND 26x30
Cod. **53** ○



380213
FUSION BIANCO LONDON 5X30
Cod. **33** ○



606152
FUSION BIANCO RETTIFICATO 60x60
Cod. **79** □



490457
FUSION BIANCO RETTIFICATO 30x60
Cod. **76** □



040945
FUSION BIANCO MOSAICO
5x5 SU RETE 30x30
Cod. **24** ○



040950
FUSION BIANCO FRAME
2,8x5,8 SU RETE 30x30
Cod. **28** ○



040961
FUSION BIANCO MOSAICO
MURETTO 3x3 SU RETE 30x33
Cod. **132** ○



040955
FUSION BIANCO MULTILEVEL
7,5x7,5 SU RETE 30x30
Cod. **43** ○

IMBALLI • PACKAGES • EMBALLAGES • FORMATE

	SCATOLA • BOX • BOITE • KARTON			PALLET • PALLETS • PALETTS • PALETTE		
	pz	m ^q	kg	box	m ^q	kg
90x90	2	1,62	37,00	18	29,16	690,00
45x90	3	1,22	28,00	32	39,04	894,00
60x60	3	1,08	23,99	40	43,20	960,00
30x60	6	1,08	23,99	40	43,20	960,00
30x30	11	0,99	23,20	46	45,54	1.090,00
10x30	20	0,60	14,00	60	36,00	870,00



909019
FUSION GRIGIO RETTIFICATO 90x90
Cod. **97** □



459018
FUSION GRIGIO RETTIFICATO 45x90
Cod. **90** □



040938
FUSION GRIGIO RETTIFICATO 30x30
Cod. **78** □



103070
FUSION GRIGIO RETTIFICATO 10x30
Cod. **77** □



040958
FUSION MOSAICO ARABESQUE BLEND 20x31
Cod. **38** ○

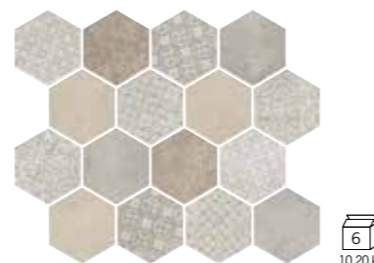

040957
FUSION DECO ESAGONO BLEND 26x30
Cod. **53** ○



380211
FUSION GRIGIO LONDON 5X30
Cod. **33** ○



606150
FUSION GRIGIO RETTIFICATO 60x60
Cod. **79** □



490451
FUSION GRIGIO RETTIFICATO 30x60
Cod. **76** □



040943
FUSION GRIGIO MOSAICO
5x5 SU RETE 30x30
Cod. **24** ○



12,30 kg

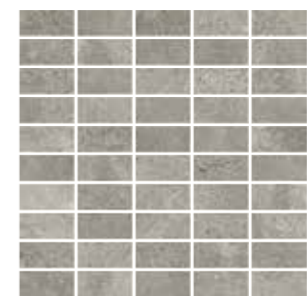

040948
FUSION GRIGIO FRAME
2,8x5,8 SU RETE 30x30
Cod. **28** ○



12,00 kg

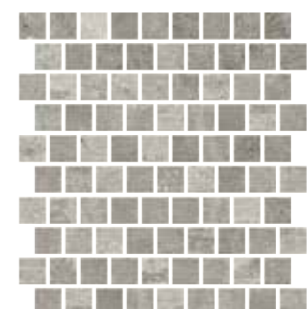

040962
FUSION GRIGIO MOSAICO
MURETTO 3x3 SU RETE 30x33
Cod. **132** ○



18,50 kg



040953
FUSION GRIGIO MULTILEVEL
7,5x7,5 SU RETE 30x30
Cod. **43** ○



11,20 kg

IMBALLI • PACKAGES • EMBALLAGES • FORMATE

	SCATOLA • BOX • BOITE • KARTON			PALLET • PALLETS • PALETTS • PALETTE		
	pz	m ^q	kg	box	m ^q	kg
90x90	2	1,62	37,00	18	29,16	690,00
45x90	3	1,22	28,00	32	39,04	894,00
60x60	3	1,08	23,99	40	43,20	960,00
30x60	6	1,08	23,99	40	43,20	960,00
30x30	11	0,99	23,20	46	45,54	1.090,00
10x30	20	0,60	14,00	60	36,00	870,00

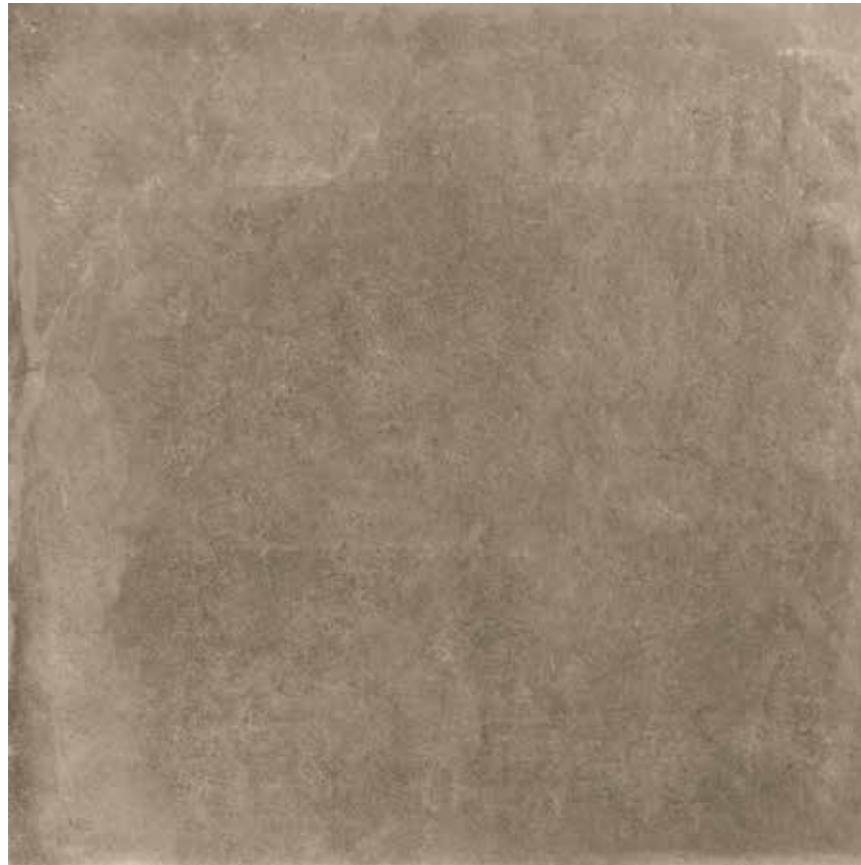

909020
FUSION TORTORA RETTIFICATO 90x90
Cod. **97** □



459017
FUSION TORTORA RETTIFICATO 45x90
Cod. **90** □



040937
FUSION TORTORA RETTIFICATO 30x30
Cod. **78** □



103069
FUSION TORTORA RETTIFICATO 10x30
Cod. **77** □



040958
FUSION MOSAICO ARABESQUE BLEND 20x31
Cod. **38** ○

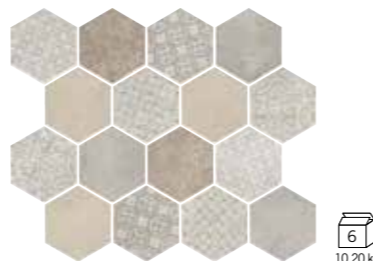

040957
FUSION DECO ESAGONO BLEND 26x30
Cod. **53** ○



380210
FUSION TORTORA LONDON 5x30
Cod. **33** ○



606151
FUSION TORTORA RETTIFICATO 60x60
Cod. **79** □



490452
FUSION TORTORA RETTIFICATO 30x60
Cod. **76** □



040942
FUSION TORTORA MOSAICO
5x5 SU RETE 30x30
Cod. **24** ○

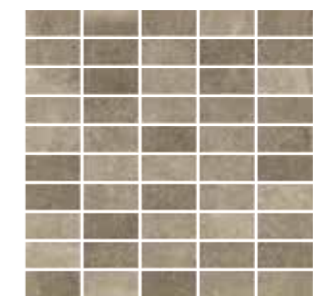

040947
FUSION TORTORA FRAME
2,8x5,8 SU RETE 30x30
Cod. **28** ○

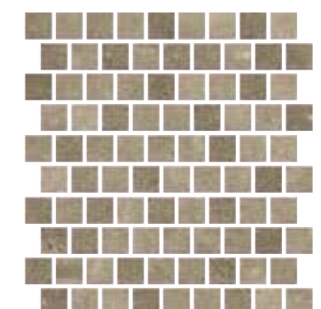

040963
FUSION TORTORA MOSAICO
MURETTO 3x3 SU RETE 30x33
Cod. **132** ○



040952
FUSION TORTORA MULTILEVEL
7,5x7,5 SU RETE 30x30
Cod. **43** ○

IMBALLI • PACKAGES • EMBALLAGES • FORMATE

	SCATOLA • BOX • BOITE • KARTON			PALLET • PALLETS • PALETTS • PALETTE		
	pz	m ^q	kg	box	m ^q	kg
90x90	2	1,62	37,00	18	29,16	690,00
45x90	3	1,22	28,00	32	39,04	894,00
60x60	3	1,08	23,99	40	43,20	960,00
30x60	6	1,08	23,99	40	43,20	960,00
30x30	11	0,99	23,20	46	45,54	1.090,00
10x30	20	0,60	14,00	60	36,00	870,00

Pezzi speciali • Special trims • Pièces spéciales • Formstücke

Battiscopa



290609
FUSION TORTORA BATTISCOPA 5x30
Cod. **116** △

290613
FUSION ANTRACITE BATTISCOPA 5x30
Cod. **116** △

290612
FUSION BIANCO BATTISCOPA 5x30
Cod. **116** △

290611
FUSION BEIGE BATTISCOPA 5x30
Cod. **116** △

290610
FUSION GRIGIO BATTISCOPA 5x30
Cod. **116** △

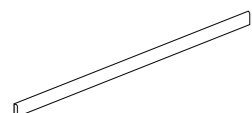

290614
FUSION TORTORA BATTISCOPA 5x60
Cod. **121** △

290618
FUSION ANTRACITE BATTISCOPA 5x60
Cod. **121** △

290617
FUSION BIANCO BATTISCOPA 5x60
Cod. **121** △

290616
FUSION BEIGE BATTISCOPA 5x60
Cod. **121** △

290615
FUSION GRIGIO BATTISCOPA 5x60
Cod. **121** △

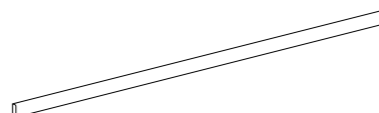

290623
FUSION TORTORA BATTISCOPA 5x90
Cod. **33** △

290619
FUSION ANTRACITE BATTISCOPA 5x90
Cod. **33** △

290621
FUSION BIANCO BATTISCOPA 5x90
Cod. **33** △

290620
FUSION BEIGE BATTISCOPA 5x90
Cod. **33** △

290622
FUSION GRIGIO BATTISCOPA 5x90
Cod. **33** △

Gradino

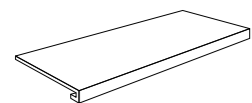

490462
FUSION TORTORA GRADINO 33x60
Cod. **112** ○

490458
FUSION ANTRACITE GRADINO 33x60
Cod. **112** ○

490460
FUSION BIANCO GRADINO 33x60
Cod. **112** ○

490459
FUSION BEIGE GRADINO 33x60
Cod. **112** ○

490461
FUSION GRIGIO GRADINO 33x60
Cod. **112** ○

Angolare

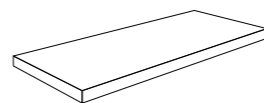

490467
FUSION TORTORA ANGOLARE 33x60
Cod. **107** ○

490463
FUSION ANTRACITE ANGOLARE 33x60
Cod. **107** ○

490465
FUSION BIANCO ANGOLARE 33x60
Cod. **107** ○

490464
FUSION BEIGE ANGOLARE 33x60
Cod. **107** ○

490466
FUSION GRIGIO ANGOLARE 33x60
Cod. **107** ○

Gradino

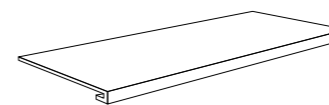

490472
FUSION TORTORA GRADINO 33x90
Cod. **114** ○

490468
FUSION ANTRACITE GRADINO 33x90
Cod. **114** ○

490470
FUSION BIANCO GRADINO 33x90
Cod. **114** ○

490469
FUSION BEIGE GRADINO 33x90
Cod. **114** ○

490471
FUSION GRIGIO GRADINO 33x90
Cod. **114** ○

Angolare

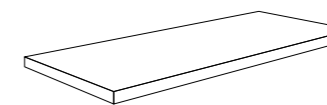

490477
FUSION TORTORA ANGOLARE 33x90
Cod. **110** ○

490473
FUSION ANTRACITE ANGOLARE 33x90
Cod. **110** ○

490475
FUSION BIANCO ANGOLARE 33x90
Cod. **110** ○

490474
FUSION BEIGE ANGOLARE 33x90
Cod. **110** ○

490476
FUSION GRIGIO ANGOLARE 33x90
Cod. **110** ○

CARATTERISTICHE DI QUALITÀ
Quality characteristics
Caractéristiques de qualité
Qualitätseigenschaften

NORMA
Norm
Norme
Norme

REQUISITO NORMA
Required standards
Valeur prescrite selon la norme
Normvorgabe

RISULTATO
Result
Résultat
Ergebniss

	Assorbimento d'acqua Water absorption of the body Absorption d'eau de support Wasseraufnahme des Scherbens	ISO 10545-3	≤ 0,5	Conforme Conformity Conforme Gemäss
	Resistenza a flessione Breaking strenght Résistance à la flexion Biegefestigkeit	ISO 10545-4	≥ 35 N/mm ²	Conforme Conformity Conforme Gemäss
	Resistenza all'abrasione Abrasion resistance Résistance à l'abrasion Abriebbeständigkeit	ISO 10545-7		PEI V
	Resistenza al gelo Frost resistance Résistance au gel Frostbeständigkeit	ISO 10545-12	Nessun campione deve presentare rotture o alterazioni apprezzabili alla superficie No samples must show ruptures or noticeable surface alteration Aucuns enchantions doit présenter ruptures ou altérations appréciables de la surface Keines der Muster sollte Risse oder sichtbare Fehler der Oberflaeche zeigen	Conforme Conformity Conforme Gemäss
	Resistenza all'attacco chimico Chemical resistance Résistance à l'attaque chimique Beständigkeit gegen chemikalien	ISO 10545-13		GA GLA
	Resistenza agli sbalzi termici Thermal shock resistance Résistance aux écarts de température Temperaturwechselbeständigkeit	ISO 10545-5		Conforme Conformity Conforme Gemäss
	Resistenza scivolosità Sliding resistance Résistance au glissement Rutschfestigkeit	DIN 51130 R		R10
	Resistenza scivolosità Sliding resistance Résistance au glissement Rutschfestigkeit	DIN 51097 (A+B+C)		A+B
	Coefficiente d'attrito dinamico Wet dynamic coefficient of friction Coefficient de friction dynamique Reibungskoeffizient Schlupfgrigkeit (in Bewegung)	Bot 3000 E	DCOF ≥ 0,42	> 0,42
	Moderata variazione Moderate variation Variation modérée Mäßige Abweichung			V3

V1
Aspetto uniforme
Uniform appearance
Aspect uniforme
Einheitliches Aussehen

V2
Lieve variazione
Slight variation
Légère variation
Geringe Abweichung

V3
Moderata variazione
Moderate variation
Variation modérée
Mäßige Abweichung

V4
Forte stonalizzazione
Substantial variation
Effet dénuancé très accentué
Akzentuierte Variation

PER UNA POSA OTTIMALE DEL PRODOTTO CONSIGLIAMO SEMPRE DI MESCOLARE ALMENO TRE SCATOLE DI MATERIALE.
For the best product laying results, material from at least three boxes should be mixed.

Pour une pose excellente, nous recommandons toujours de mélanger le contenu d'au moins trois boîtes.

Für eine optimale Verlegung des Erzeugnisses empfehlen wir stets, mindestens drei Packungen Material anzumischen.



Tipologia
Type
Typologie
Typ
Gres porcellanato smaltato
Glazed porcelain
Grès cérame emaille
Feinsteinzeug glasiert

Formati
Sizes
Formats
Formate
30x60
15x60
30x30
10x30
15x15
7,5x15
10x10

Spessore
Thickness
Épaisseur
Stärke
10 mm

Resistenza scivolosità
Sliding resistance
Resistance au glissement
Rutschfestigkeit
R9

Grado di variazione cromatica
Degree of colour change
Degré de variation chromatique
Grad der Farbabweichung
V3



490358
GLAMSTONE NAMIBIAN GREY
RETTIFICATO 30x60
Cod. **76** □



550096
GLAMSTONE NAMIBIAN GREY RETTIFICATO 15x60
Cod. **76** □



040822
GLAMSTONE NAMIBIAN GREY SFUSO 7,5x15
Cod. **95** □



040818
GLAMSTONE NAMIBIAN GREY
RETTIFICATO 30x30
Cod. **78** □



103046
GLAMSTONE NAMIBIAN GREY
RETTIFICATO 10x30
Cod. **77** □



230232
GLAMSTONE NAMIBIAN GREY
RETTIFICATO 15x15
Cod. **78** □



450350
GLAMSTONE NAMIBIAN GREY
RETTIFICATO 10x10
Cod. **90** □



040826
GLAMSTONE NAMIBIAN GREY MOSAICO
5x5 SU RETE 30x30
Cod. **24** ○



12,00 kg

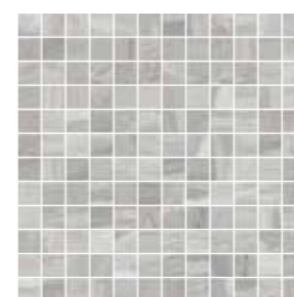

501128
GLAMSTONE NAMIBIAN GREY MOSAICO
2,4x2,4 SU RETE 30x30
Cod. **132** ○



12,00 kg



380162
GLAMSTONE LISTELLO MIX 7x30
Cod. **128** ○



4,50 kg



040830
GLAMSTONE NAMIBIAN GREY MOSAICO
MURETTO 2,4x10 SU RETE 30x30
Cod. **46** ○



18,80 kg



380168
GLAMSTONE NAMIBIAN GREY
LONDON 5x30
Cod. **33** ○



5,36 kg

IMBALLI • PACKAGES • EMBALLAGES • FORMATE

	SCATOLA • BOX • BOITE • KARTON			PALLET • PALLETS • PALETTS • PALETTE		
	pz	mq	kg	box	mq	kg
30x60	6	1,08	24,48	40	43,20	979,00
15x60	10	0,90	19,60	48	43,20	940,80
30x30	11	0,99	23,20	46	45,54	1.067,00
10x30	20	0,60	15,00	60	36,00	910,00
15x15	46	1,035	20,20	33	34,15	666,60
10x10	50	0,50	8,70	36	18,00	313,00
7,5x15	50	0,56	11,30	76	42,56	859,00



490356
GLAMSTONE PALISSANDRO WHITE
RETTIFICATO 30x60
Cod. **76** □



040816
GLAMSTONE PALISSANDRO WHITE
RETTIFICATO 30x30
Cod. **78** □

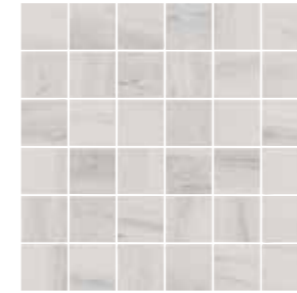

040824
GLAMSTONE PALISSANDRO WHITE MOSAICO
5x5 SU RETE 30x30
Cod. **24** ○

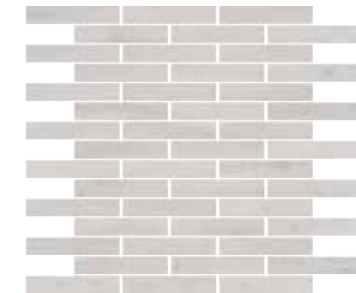

040828
GLAMSTONE PALISSANDRO WHITE MOSAICO
MURETTO 2,4x10 SU RETE 30x30
Cod. **46** ○



550096
GLAMSTONE PALISSANDRO WHITE RETTIFICATO 15x60
Cod. **76** □



103044
GLAMSTONE PALISSANDRO WHITE
RETTIFICATO 10x30
Cod. **77** □

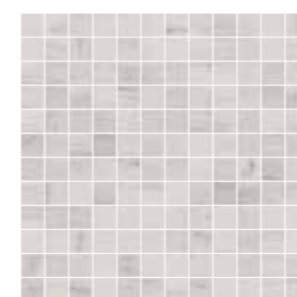

501126
GLAMSTONE PALISSANDRO WHITE MOSAICO
2,4x2,4 SU RETE 30x30
Cod. **132** ○



380166
GLAMSTONE PALISSANDRO WHITE
LONDON 5x30
Cod. **33** ○



040820
GLAMSTONE PALISSANDRO WHITE SFUSO 7,5x15
Cod. **95** □



230230
GLAMSTONE PALISSANDRO WHITE
RETTIFICATO 15x15
Cod. **78** □



380162
GLAMSTONE LISTELLO MIX 7x30
Cod. **128** ○



450348
GLAMSTONE PALISSANDRO WHITE
RETTIFICATO 10x10
Cod. **90** □

IMBALLI • PACKAGES • EMBALLAGES • FORMATE

	SCATOLA • BOX • BOITE • KARTON			PALLET • PALLETS • PALETTS • PALETTE		
	pz	m ^q	kg	box	m ^q	kg
30x60	6	1,08	24,48	40	43,20	979,00
15x60	10	0,90	19,60	48	43,20	940,80
30x30	11	0,99	23,20	46	45,54	1.067,00
10x30	20	0,60	15,00	60	36,00	910,00
15x15	46	1,035	20,20	33	34,15	666,60
10x10	50	0,50	8,70	36	18,00	313,00
7,5x15	50	0,56	11,30	76	42,56	859,00



490359
GLAMSTONE BREACH CREAM
RETTIFICATO 30x60
Cod. **76** □

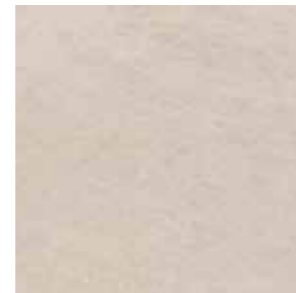

040819
GLAMSTONE BREACH CREAM
RETTIFICATO 30x30
Cod. **78** □



040827
GLAMSTONE BREACH CREAM MOSAICO
5x5 SU RETE 30x30
Cod. **24** ○



12,00 kg

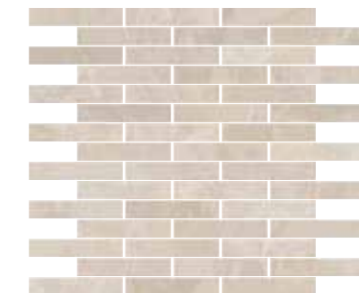

040831
GLAMSTONE BREACH CREAM MOSAICO
MURETTO 2,4x10 SU RETE 30x30
Cod. **46** ○



18,80 kg



550097
GLAMSTONE BREACH CREAM RETTIFICATO 15x60
Cod. **76** □



103047
GLAMSTONE BREACH CREAM
RETTIFICATO 10x30
Cod. **77** □



040823
GLAMSTONE BREACH CREAM SFUSO 7,5x15
Cod. **95** □



230233
GLAMSTONE BREACH CREAM
RETTIFICATO 15x15
Cod. **78** □



12,00 kg

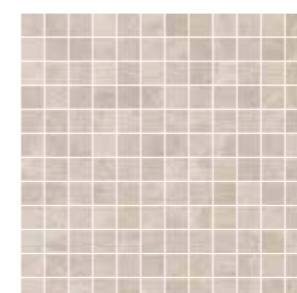

501129
GLAMSTONE BREACH CREAM MOSAICO
2,4x2,4 SU RETE 30x30
Cod. **132** ○



380169
GLAMSTONE BREACH CREAM
LONDON 5x30
Cod. **33** ○



5,36 kg



450351
GLAMSTONE BREACH CREAM
RETTIFICATO 10x10
Cod. **90** □



4,50 kg



380162
GLAMSTONE LISTELLO MIX 7x30
Cod. **128** ○

IMBALLI • PACKAGES • EMBALLAGES • FORMATE

	SCATOLA • BOX • BOITE • KARTON			PALLET • PALLETS • PALETTS • PALETTE		
	pz	mq	kg	box	mq	kg
30x60	6	1,08	24,48	40	43,20	979,00
15x60	10	0,90	19,60	48	43,20	940,80
30x30	11	0,99	23,20	46	45,54	1.067,00
10x30	20	0,60	15,00	60	36,00	910,00
15x15	46	1,035	20,20	33	34,15	666,60
10x10	50	0,50	8,70	36	18,00	313,00
7,5x15	50	0,56	11,30	76	42,56	859,00



490357
GLAMSTONE CALACATTA IVORY
RETTIFICATO 30x60
Cod. **76** □



550095
GLAMSTONE CALACATTA IVORY RETTIFICATO 15x60
Cod. **76** □



040821
GLAMSTONE CALACATTA IVORY SFUSO 7,5x15
Cod. **95** □



040817
GLAMSTONE CALACATTA IVORY
RETTIFICATO 30x30
Cod. **78** □



103045
GLAMSTONE CALACATTA IVORY
RETTIFICATO 10x30
Cod. **77** □



230231
GLAMSTONE CALACATTA IVORY
RETTIFICATO 15x15
Cod. **78** □



450349
GLAMSTONE CALACATTA IVORY
RETTIFICATO 10x10
Cod. **90** □



040825
GLAMSTONE CALACATTA IVORY
MOSAICO 5x5 SU RETE 30x30
Cod. **24** ○



12,00 kg

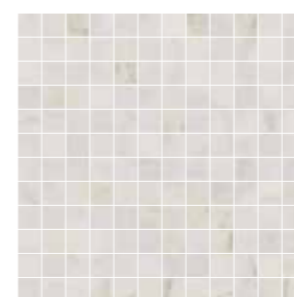

501127
GLAMSTONE CALACATTA IVORY MOSAICO
2,4x2,4 SU RETE 30x30
Cod. **132** ○



12,00 kg



380162
GLAMSTONE LISTELLO MIX 7x30
Cod. **128** ○



4,50 kg



040829
GLAMSTONE CALACATTA IVORY MOSAICO
MURETTO 2,4x10 SU RETE 30x30
Cod. **46** ○



18,80 kg



380167
GLAMSTONE CALACATTA IVORY
LONDON 5x30
Cod. **33** ○



5,36 kg

IMBALLI • PACKAGES • EMBALLAGES • FORMATE

	SCATOLA • BOX • BOITE • KARTON			PALLET • PALLETS • PALETTS • PALETTE		
	pz	mq	kg	box	mq	kg
30x60	6	1,08	24,48	40	43,20	979,00
15x60	10	0,90	19,60	48	43,20	940,80
30x30	11	0,99	23,20	46	45,54	1.067,00
10x30	20	0,60	15,00	60	36,00	910,00
15x15	46	1,035	20,20	33	34,15	666,60
10x10	50	0,50	8,70	36	18,00	313,00
7,5x15	50	0,56	11,30	76	42,56	859,00



Pezzi speciali • Special trims • Pièces spéciales • Formstücke

Battiscopa  23,60 kg

 23,60 kg

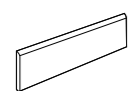



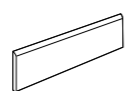









290555
GLAMSTONE NAMIBIAN GREY
BATTISCOPA 7x30
Cod. **116** △



290554
GLAMSTONE CALACATTA IVORY
BATTISCOPA 7x30
Cod. **116** △

290553
GLAMSTONE PALISSANDRO WHITE
BATTISCOPA 7x30
Cod. **116** △

290556
GLAMSTONE BREACH CREAM
BATTISCOPA 7x30
Cod. **116** △

CARATTERISTICHE DI QUALITÀ Quality characteristics Caractéristiques de qualité Qualitätseigenschaften	NORMA Norm Norme Norme	REQUISITO NORMA Required standards Valeur prescrite selon la norme Normvorgabe	RISULTATO Result Résultat Ergebniss
 Assorbimento d'acqua Water absorption of the body Absorption d'eau de support Wasseraufnahme des Scherbens	ISO 10545-3	≤ 0,5	Conforme Conformity Conforme Gemäss
 Resistenza a flessione Breaking strenght Résistance à la flexion Biegefestigkeit	ISO 10545-4	≥ 35 N/mm ²	Conforme Conformity Conforme Gemäss
 Resistenza all'abrasione Abrasion resistance Resistance a l'abrasion Abriebbeständigkeit	ISO 10545-7		PEI IV
 Resistenza al gelo Frost resistance Résistance au gel Frostbeständigkeit	ISO 10545-12	Nessun campione deve presentare rotture o alterazioni apprezzabili alla superficie No samples must show ruptures or noticeable surface alteration Aucuns enchantions doit présenter ruptures ou altérations appréciables de la surface Keines der Muster sollte Risse oder sichtbare Fehler der Oberfläche zeigen	Conforme Conformity Conforme Gemäss
 Resistenza all'attacco chimico Chemical resistance Résistance à l'attaque chimique Beständigkeit gegen chemikalien	ISO 10545-13		GA GLA
 Resistenza agli sbalzi termici Thermal shock resistance Resistance aux ecarts de température Temperaturwechselbeständigkeit	ISO 10545-5		Conforme Conformity Conforme Gemäss
 Resistenza scivolosità Sliding resistance Resistance au glissement Rutschfestigkeit	DIN 51130 R		R9
 Moderata variazione Moderate variation Variation modérée Mäßige Abweichung			V3
 Aspetto uniforme Uniform appearance Aspect uniforme Einheitliches Aussehen			V1
 Lieve variazione Slight variation Légère variation Geringe Abweichung			V2
 Moderata variazione Moderate variation Variation modérée Mäßige Abweichung			V3
 Forte stonalizzazione Substantial variation Effet dénuancé très accentué Akzentuierte Variation			V4

L'USO DEL PAVIMENTO È CONSIGLIATO SOLO PER USO RESIDENZIALE.

The use of floortiles it's recommended for residential only.
On conseille la pose des carreaux au sol seulement pour utilisation résidentielles.
Diese Bodenfliese darf ausschliesslich im privaten Wohnbereich verlegt werden.

PER UNA POSA OTTIMALE DEL PRODOTTO CONSIGLIAMO SEMPRE DI MESCOLARE ALMENO TRE SCATOLE DI MATERIALE.

For the best product laying results, material from at least three boxes should be mixed.
Pour une pose excellente, nous recommandons toujours de mélanger le contenu d'au moins trois boîtes.
Für eine optimale Verlegung des Erzeugnisses empfehlen wir stets, mindestens drei Packungen Material anzumischen.



Tipologia
Type
Typologie
Typ
Gres porcellanato smaltato
Glazed porcelain
Grès cérame emaille
Feinsteinzeug glasiert

Formati
Sizes
Formats
Formate
60x120
60x60
30x60
30x30
10x30

Spessore
Thickness
Épaisseur
Stärke
10 mm

Resistenza scivolosità
Sliding resistance
Resistance au glissement
Rutschfestigkeit
R9

Grado di variazione cromatica
Degree of colour change
Degré de variation chromatique
Grad der Farbabweichung
V3



601272
ICONIC BLUE NATURALE
RETTIFICATO 60x120
Cod. **94** □

601273
ICONIC BLUE LAPPATO
RETTIFICATO 60x120
Cod. **103** □



606217
ICONIC BLUE NATURALE
RETTIFICATO 60x60
Cod. **79** □

606218
ICONIC BLUE LAPPATO
RETTIFICATO 60x60
Cod. **93** □



490683
ICONIC BLUE NATURALE
RETTIFICATO 30x60
Cod. **76** □

490684
ICONIC BLUE LAPPATO
RETTIFICATO 30x60
Cod. **85** □



041140
ICONIC BLUE NATURALE RETTIFICATO 30x30
Cod. **78** □

041141
ICONIC BLUE LAPPATO RETTIFICATO 30x30
Cod. **90** □



103115
ICONIC BLUE NATURALE
RETTIFICATO 10x30
Cod. **77** □

103116
ICONIC BLUE LAPPATO
RETTIFICATO 10x30
Cod. **93** □



11,40 kg

041230
ICONIC BLUE NATURALE
MOSAICO 5x5 SU RETE 30x30
Cod. **24** ○

041231
ICONIC BLUE LAPPATO
MOSAICO 5x5 SU RETE 30x30
Cod. **31** ○



10,30 kg

041232
ICONIC BLUE NATURALE
ESAGONO 27x28
Cod. **136** ○

041233
ICONIC BLUE LAPPATO
ESAGONO 27x28
Cod. **49** ○



13,20 kg

041224
ICONIC BLUE NATURALE
MOSAICO HB 28x32
Cod. **45** ○

041225
ICONIC BLUE LAPPATO
MOSAICO HB 28x32
Cod. **48** ○



10,30 kg

041210
ICONIC BLUE NATURALE
ESAGONO INTARSIO 20,7x27
Cod. **57** ○

041211
ICONIC BLUE LAPPATO
ESAGONO INTARSIO 20,7x27
Cod. **72** ○



4,5 kg

380295
ICONIC BLUE NATURALE
BORDURA MURETTO 7x30
Cod. **28** ○

380296
ICONIC BLUE LAPPATO
BORDURA MURETTO 7x30
Cod. **28** ○



6,44 kg

380289
ICONIC BLUE NATURALE
LONDON 5x30
Cod. **33** ○

380290
ICONIC BLUE LUCIDO
LONDON 5x30
Cod. **33** ○

IMBALLI • PACKAGES • EMBALLAGES • FORMATE

	SCATOLA • BOX • BOITE • KARTON			PALLET • PALLETS • PALETTS • PALETTE		
	pz	mq	kg	box	mq	kg
60x120	2	1,44	33,00	30	43,20	1.010,00
60x60	3	1,08	24,10	40	43,20	980,00
30x60	6	1,08	24,48	40	43,20	980,00
30x30	11	0,99	23,20	46	45,54	1.070,00
10x30	20	0,60	15,00	60	36,00	920,00



iconic blue RETT. LAPPATO

La finitura lappata è consigliata per uso rivestimento o per pavimenti da bagno in ambito residenziale. Nello specifico il tipo di pavimentazione deve essere non soggetta ad eccessive sollecitazioni e mai a diretto contatto con aree esterne. Come si verifica comunemente nelle pietre naturali l'eventuale presenza di puntini sulla superficie o di qualche disuniformità della lucentezza sono da considerare caratteristiche del prodotto derivanti dalla lavorazione a cui viene sottoposto.

The polished finish is recommended for wall coverings or for the floors of residential bathrooms. Specifically, floor coverings in this material must not be subjected to excessively heavy traffic and must never be in direct contact with outdoor areas. As is often the case with natural stones, any spots on the surface or any unevenness in shine are typical characteristics of the product, deriving from the process used.

La finitura polie est recommandée pour le revêtement sol et mur des salles de bains résidentielles. Notamment, ce type de carreau au sol ne doit pas être exposé à des contraintes excessives, et il ne doit jamais être en contact direct avec des zones extérieures. Comme cela est souvent le cas pour les pierres naturelles, les micro trous éventuellement présents à la surface du produit ou l'hétérogénéité de son éclat forment des caractéristiques propres au façonnage.

Die polierte Oberfläche wird für Wandverkleidungen und Bodenbeläge in Privatbädern empfohlen. Der Bodenbelag darf keinen starken Beanspruchungen ausgesetzt sein und keinen direkten Kontakt zu Außenbereichen haben. Wie bei Natursteinen üblich, kann die Oberfläche Körnungen oder einen unregelmäßigen Glanz aufweisen. Diese Merkmale sind typische, beabsichtigte Produkteigenschaften, die durch das Bearbeitungsverfahren hervorgerufen werden.

Pezzi speciali • Special trims • Pièces spéciales • Formstücke

Battiscopa

44
23,60 kg

18
18,00 kg

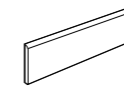

290758
ICONIC BLUE NATURALE
BATTISCOPA 7x30
Cod. **116** △

290759
ICONIC BLUE LAPPATO
BATTISCOPA 7x30
Cod. **22** △

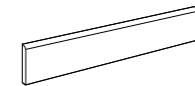

290764
ICONIC BLUE NATURALE
BATTISCOPA 7x60
Cod. **121** △

290765
ICONIC BLUE LAPPATO
BATTISCOPA 7x60
Cod. **26** △

CARATTERISTICHE DI QUALITÀ Quality characteristics Caractéristiques de qualité Qualitätseigenschaften	NORMA Norm Norme Norme	REQUISITO NORMA Required standards Valeur prescrite selon la norme Normvorgabe	RISULTATO Result Résultat Ergebniss
Assorbimento d'acqua Water absorption of the body Absorption d'eau de support Wasseraufnahme des Scherbens	ISO 10545-3	≤ 0,5	Conforme Conformity Conforme Gemäss
Resistenza a flessione Breaking strenght Résistance à la flexion Biegefestigkeit	ISO 10545-4	≥ 35 N/mm ²	Conforme Conformity Conforme Gemäss
Resistenza all'abrasione Abrasion resistance Résistance à l'abrasion Abriebbeständigkeit	ISO 10545-7	Iconic Blue Rettificato	PEI IV
Resistenza al gelo Frost resistance Résistance au gel Frostbeständigkeit	ISO 10545-12	Nessun campione deve presentare rotture o alterazioni apprezzabili alla superficie No samples must show ruptures or noticeable surface alteration Aucuns enchantions doit présenter ruptures ou altérations appréciables de la surface Keines der Muster sollte Risse oder sichtbare Fehler der Oberflaeche zeigen	Conforme Conformity Conforme Gemäss
Resistenza all'attacco chimico Chemical resistance Résistance à l'attaque chimique Beständigkeit gegen chemikalien	ISO 10545-13	Iconic Blue Naturale Iconic Blue Lappato	GA GLA GA GLB
Resistenza agli sbalzi termici Thermal shock resistance Résistance aux écarts de température Temperaturwechselbeständigkeit	ISO 10545-5		Conforme Conformity Conforme Gemäss
Resistenza scivolosità Sliding resistance Résistance au glissement Rutschfestigkeit	DIN 51130 R		R9
Moderata variazione Moderate variation Variation modérée Mäßige Abweichung		Iconic Blue Rettificato	V3

Aspetto uniforme
Uniform appearance
Aspect uniforme
Einheitliches Aussehen
V1

Lieve variazione
Slight variation
Légère variation
Geringe Abweichung
V2

Moderata variazione
Moderate variation
Variation modérée
Mäßige Abweichung
V3

Forte stonalizzazione
Substantial variation
Effet dénuancé très accentué
Akzentuierte Variation
V4

PER UNA POSA OTTIMALE DEL PRODOTTO CONSIGLIAMO SEMPRE DI MESCOLARE ALMENO TRE SCATOLE DI MATERIALE.

For the best product laying results, material from at least three boxes should be mixed.

Pour une pose excellente, nous recommandons toujours de mélanger le contenu d'au moins trois boîtes.

Für eine optimale Verlegung des Erzeugnisses empfehlen wir stets, mindestens drei Packungen Material anzumischen.



Tipologia
Type
Typologie
Typ
Gres porcellanato smaltato
Glazed porcelain
Grès cérame emaille
Feinsteinzeug glasiert

Formati
Sizes
Formats
Formate
30x60
30x30
10x30
5x20

Spessore
Thickness
Épaisseur
Stärke
10 mm

Resistenza scivolosità
Sliding resistance
Resistance au glissement
Rutschfestigkeit
R10 / A+B

Grado di variazione cromatica
Degree of colour change
Degré de variation chromatique
Grad der Farbabweichung
V2



490431
LANDSCAPE BLACK
RETTIFICATO 30x60
Cod. **76** □



040928
LANDSCAPE BLACK
RETTIFICATO 30x30
Cod. **78** □



103068
LANDSCAPE BLACK
RETTIFICATO 10x30
Cod. **77** □



050208
LANDSCAPE BLACK
RETTIFICATO 5x20 (SFUSO)
Cod. **93** □



310195
LANDSCAPE BLACK
LONDON 4x30
Cod. **33** ○  6,48 kg



490429
LANDSCAPE GREY
RETTIFICATO 30x60
Cod. **76** □



040926
LANDSCAPE GREY
RETTIFICATO 30x30
Cod. **78** □



103066
LANDSCAPE GREY
RETTIFICATO 10x30
Cod. **77** □



050206
LANDSCAPE GREY
RETTIFICATO 5x20 (SFUSO)
Cod. **93** □



310193
LANDSCAPE GREY
LONDON 4x30
Cod. **33** ○  6,48 kg

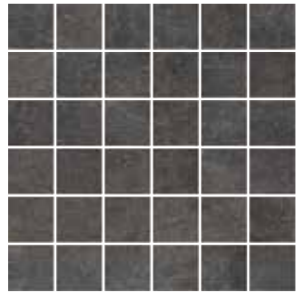

040932
LANDSCAPE BLACK MOSAICO 5x5
SU RETE 30x30
Cod. **24** ○  12,00 kg

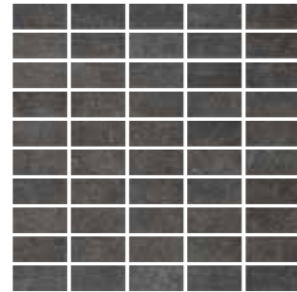

040936
LANDSCAPE BLACK FRAME
2,8x5,8 SU RETE 30x30
Cod. **31** ○  12,00 kg



380205
LANDSCAPE BLACK BORDURA
MULTILEVEL 7,5x29
Cod. **123** ○  3,12 kg



040930
LANDSCAPE GREY MOSAICO
5x5 SU RETE 30x30
Cod. **24** ○  12,00 kg

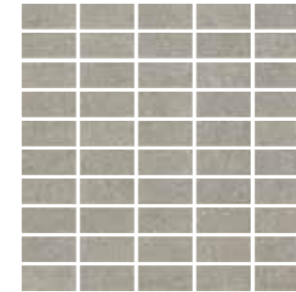

040934
LANDSCAPE GREY FRAME
2,8x5,8 SU RETE 30x30
Cod. **31** ○  12,00 kg



380203
LANDSCAPE GREY BORDURA
MULTILEVEL 7,5x29
Cod. **123** ○  3,12 kg



490456
LANDSCAPE BLACK WALL SU RETE 15x60
Cod. **70** ○  5,80 kg



490454
LANDSCAPE GREY WALL SU RETE 15x60
Cod. **70** ○  5,80 kg

IMBALLI • PACKAGES • EMBALLAGES • FORMATE

	SCATOLA • BOX • BOITE • KARTON			PALLET • PALLETS • PALETTS • PALETTE		
	pz	m ^q	kg	box	m ^q	kg
30x60	6	1,08	25,30	40	43,20	1.030,00
30x30	11	0,99	23,00	46	45,54	1.058,00
10x30	20	0,60	14,00	60	36,00	920,00
5x20	56	0,56	12,30	60	33,60	760,00

IMBALLI • PACKAGES • EMBALLAGES • FORMATE

	SCATOLA • BOX • BOITE • KARTON			PALLET • PALLETS • PALETTS • PALETTE		
	pz	m ^q	kg	box	m ^q	kg
30x60	6	1,08	25,30	40	43,20	1.030,00
30x30	11	0,99	23,00	46	45,54	1.058,00
10x30	20	0,60	14,00	60	36,00	920,00
5x20	56	0,56	12,30	60	33,60	760,00



490428
LANDSCAPE IVORY
RETTIFICATO 30x60
Cod. **76** □



040925
LANDSCAPE IVORY
RETTIFICATO 30x30
Cod. **78** □

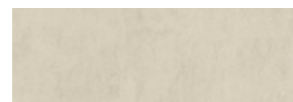

103065
LANDSCAPE IVORY
RETTIFICATO 10x30
Cod. **77** □

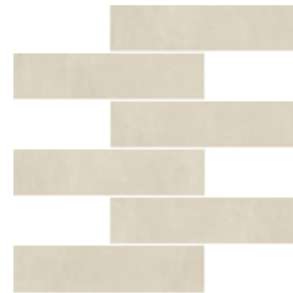

050205
LANDSCAPE IVORY
RETTIFICATO 5x20 (SFUSO)
Cod. **93** □



310192
LANDSCAPE IVORY
LONDON 4X30
Cod. **33** ○



6,48 kg

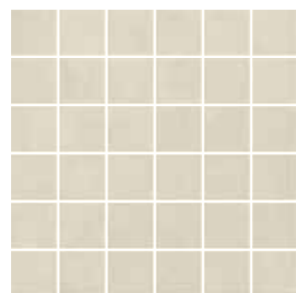

040929
LANDSCAPE IVORY MOSAICO
5x5 SU RETE 30x30
Cod. **24** □



12,00 kg

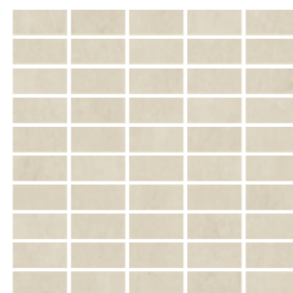

040933
LANDSCAPE IVORY FRAME
2,8x5,8 SU RETE 30x30
Cod. **31** ○



12,00 kg



380202
LANDSCAPE IVORY BORDURA
MULTILEVEL 7,5x29
Cod. **123** ○



3,12 kg



5,80 kg

490453
LANDSCAPE IVORY WALL SU RETE 15x60
Cod. **70** ○

IMBALLI • PACKAGES • EMBALLAGES • FORMATE

	SCATOLA • BOX • BOITE • KARTON			PALLET • PALLETS • PALETTS • PALETTE		
	pz	mq	kg	box	mq	kg
30x60	6	1,08	25,30	40	43,20	1.030,00
30x30	11	0,99	23,00	46	45,54	1.058,00
10x30	20	0,60	14,00	60	36,00	920,00
5x20	56	0,56	12,30	60	33,60	760,00



490430
LANDSCAPE MUD
RETTIFICATO 30x60
Cod. **76** □



040927
LANDSCAPE MUD
RETTIFICATO 30x30
Cod. **78** □



103067
LANDSCAPE MUD
RETTIFICATO 10x30
Cod. **77** □

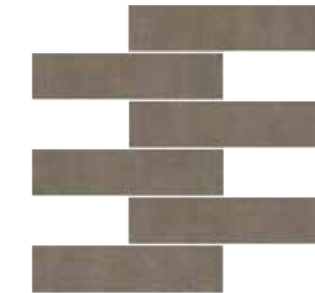

050207
LANDSCAPE MUD
RETTIFICATO 5x20 (SFUSO)
Cod. **93** □



310194
LANDSCAPE MUD
LONDON 4X30
Cod. **33** ○



6,48 kg

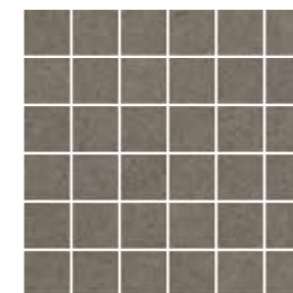

040931
LANDSCAPE MUD MOSAICO
5x5 SU RETE 30x30
Cod. **24** □



12,00 kg

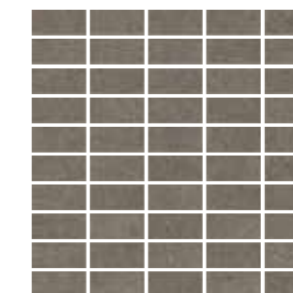

040935
LANDSCAPE MUD FRAME
2,8x5,8 SU RETE 30x30
Cod. **31** ○



12,00 kg



380204
LANDSCAPE MUD BORDURA
MULTILEVEL 7,5x29
Cod. **123** ○



3,12 kg



5,80 kg

490455
LANDSCAPE MUD WALL SU RETE 15x60
Cod. **70** ○

IMBALLI • PACKAGES • EMBALLAGES • FORMATE

	SCATOLA • BOX • BOITE • KARTON			PALLET • PALLETS • PALETTS • PALETTE		
	pz	mq	kg	box	mq	kg
30x60	6	1,08	25,30	40	43,20	1.030,00
30x30	11	0,99	23,00	46	45,54	1.058,00
10x30	20	0,60	14,00	60	36,00	920,00
5x20	56	0,56	12,30	60	33,60	760,00

Pezzi speciali • Special trims • Pièces spéciales • Formstücke

Battiscopa

40
13,30 kg



290601
LANDSCAPE BLACK BATTISCOPA
5x30 Cod. **116** △

290602
LANDSCAPE GREY BATTISCOPA
5x30 Cod. **116** △

290603
LANDSCAPE IVORY BATTISCOPA
5x30 Cod. **116** △

290604
LANDSCAPE MUD BATTISCOPA
5x30 Cod. **116** △

20
13,40 kg

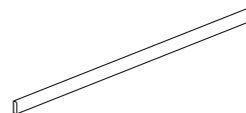

290605
LANDSCAPE BLACK BATTISCOPA
5x60 Cod. **121** △

290606
LANDSCAPE GREY BATTISCOPA
5x60 Cod. **121** △

290607
LANDSCAPE IVORY BATTISCOPA
5x60 Cod. **121** △

290608
LANDSCAPE MUD BATTISCOPA
5x60 Cod. **121** △

Gradino

2
10,00 kg

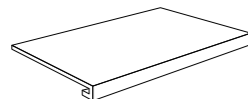

490523
LANDSCAPE BLACK GRADINO
33x60 Cod. **112** ○

490524
LANDSCAPE GREY GRADINO
33x60 Cod. **112** ○

490525
LANDSCAPE IVORY GRADINO
33x60 Cod. **112** ○

490526
LANDSCAPE MUD GRADINO
33x60 Cod. **112** ○

Angolare

2
10,00 kg

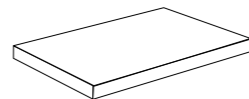

490541
LANDSCAPE BLACK ANGOLARE
33x60 Cod. **107** ○

490542
LANDSCAPE GREY ANGOLARE
33x60 Cod. **107** ○

490543
LANDSCAPE IVORY ANGOLARE
33x60 Cod. **107** ○

490544
LANDSCAPE MUD ANGOLARE
33x60 Cod. **107** ○

CARATTERISTICHE DI QUALITÀ Quality characteristics Caractéristiques de qualité Qualitätseigenschaften	NORMA Norm Norme Norme	REQUISITO NORMA Required standards Valeur prescrite selon la norme Normvorgabe	RISULTATO Result Résultat Ergebniss
Assorbimento d'acqua Water absorption of the body Absorption d'eau de support Wasseraufnahme des Scherbens	ISO 10545-3	≤ 0,5	Conforme Conformity Conforme Gemäss
Resistenza a flessione Breaking strenght Résistance à la flexion Biegefestigkeit	ISO 10545-4	≥ 35 N/mm ²	Conforme Conformity Conforme Gemäss
Resistenza all'abrasione Abrasion resistance Resistance a l'abrasion Abriebbeständigkeit	ISO 10545-7		PEI V
Resistenza al gelo Frost resistance Résistance au gel Frostbeständigkeit	ISO 10545-12	Nessun campione deve presentare rotture o alterazioni apprezzabili alla superficie No samples must show ruptures or noticeable surface alteration Aucuns enchantions doit présenter ruptures ou altérations appréciables de la surface Keines der Muster sollte Risse oder sichtbare Fehler der Oberflaeche zeigen	Conforme Conformity Conforme Gemäss
Resistenza all'attacco chimico Chemical resistance Résistance à l'attaque chimique Beständigkeit gegen chemikalien	ISO 10545-13		GA GLA
Resistenza agli sbalzi termici Thermal shock resistance Resistance aux ecart de température Temperaturwechselbeständigkeit	ISO 10545-5		Conforme Conformity Conforme Gemäss
Resistenza scivolosità Sliding resistance Resistance au glissement Rutschfestigkeit	DIN 51130 R		R10
Resistenza scivolosità Sliding resistance Resistance au glissement Rutschfestigkeit	DIN 51097 (A+B+C)		A+B
Coefficiente d'attrito dinamico Wet dynamic coefficient of friction Coefficient de friction dynamique Reibungskoeffizient Schlipfrigkeit (in Bewegung)	Bot 3000 E	DCOF ≥ 0,42	> 0,42
Lieve variazione Slight variation Légère variation Geringe Abweichung			V2

V1
Aspetto uniforme
Uniform appearance
Aspect uniforme
Einheitliches Aussehen

V2
Lieve variazione
Slight variation
Légère variation
Geringe Abweichung

V3
Moderata variazione
Moderate variation
Variation modérée
Mäßige Abweichung

V4
Forte stonalizzazione
Substantial variation
Effet dénuancé très accentué
Akzentuierte Variation

PER UNA POSA OTTIMALE DEL PRODOTTO CONSIGLIAMO SEMPRE DI MESCOLARE ALMENO TRE SCATOLE DI MATERIALE.

For the best product laying results, material from at least three boxes should be mixed.

Pour une pose excellente, nous recommandons toujours de mélanger le contenu d'au moins trois boîtes.

Für eine optimale Verlegung des Erzeugnisses empfehlen wir stets, mindestens drei Packungen Material anzumischen.

(A)

Il prodotto non è resistente agli acidi. Proteggere la superficie del materiale durante le operazioni di posa.

Non usare abrasivi nella pulizia. Utilizzare detergenti neutri. Per nessun motivo saranno accolte contestazioni sul materiale posato.

Le materiel n'est pas résistant à l'attaque chimique. Protéger la surface du material pendant les operations de pose.

N'utiliser pas des abrasifs pour nettoyer. Utiliser produits neutrales. On pourra pas accepter réclamations sur le materiel posé.

This product has no chemical resistance. Shelter surface of the material during pose operations.

Don't use abrasive products for cleaning. Use only neutral products. For no reasons we'll accept claim on posed material.

Dieser Artikel ist nicht Laugen- und Saeurebestaendig. Die Oberflaeche waehrend der Verlegearbeiten schuetzen. Keine Schleifmittel fuer die Reinigung benutzen. Nur neutrale Reiniger verwenden. Es werden unter keinen Umstaenden Reklamationen NACH der Verlegung akzeptiert.



Tipologia
Type
Typologie
Typ
Gres porcellanato smaltato
Glazed porcelain
Grès cérame emaille
Feinsteinzeug glasiert

Formati
Sizes
Formats
Formate
26,5x180
30x120
20x120
10x60
10x53,7

Spessore
Thickness
Épaisseur
Stärke
10 mm
20 mm

Resistenza scivolosità
Sliding resistance
Resistance au glissement
Rutschfestigkeit
R10 / A+B
R11 / A+B+C

Grado di variazione cromatica
Degree of colour change
Degré de variation chromatique
Grad der Farbabweichung
V2



201225
ST. TROPEZ RETTIFICATO 26,5x180
Cod. 111 □



301257
ST. TROPEZ RETTIFICATO 30x120
Cod. 92 □



201228
ST. TROPEZ RETTIFICATO 20x120
Cod. 92 □

201231
ST. TROPEZ RETTIFICATO R11 20x120
Cod. 95 □



106037
ST. TROPEZ RETTIFICATO 10x60
Cod. 83 □



490734
ST. TROPEZ MOSAICO MURETTO
2x10 SU RETE 20x40
Cod. 125 ○



106030
ST. TROPEZ CHEVRON
RETTIFICATO 10x53,7
Cod. 112 □



201226
ANTIBES RETTIFICATO 26,5x180
Cod. 111 □



301258
ANTIBES RETTIFICATO 30x120
Cod. 92 □



201229
ANTIBES RETTIFICATO 20x120
Cod. 92 □

201232
ANTIBES RETTIFICATO R11 20x120
Cod. 95 □



106038
ANTIBES RETTIFICATO 10x60
Cod. 83 □



490735
ANTIBES MOSAICO MURETTO
2x10 SU RETE 20x40
Cod. 125 ○



106031
ANTIBES CHEVRON
RETTIFICATO 10x53,7
Cod. 112 □

IMBALLI • PACKAGES • EMBALLAGES • FORMATE

	SCATOLA • BOX • BOITE • KARTON			PALLET • PALLETS • PALETTS • PALETTE		
	pz	mq	kg	box	mq	kg
26,5x180	3	1,43	33,30	36	51,48	1.200,00
30x120	4	1,44	31,50	24	34,56	775,00
20x120	4	0,96	21,10	48	46,08	1.030,00
10x60	12	0,72	16,00	60	43,20	985,00
10x53,7	12	0,65	14,80	60	39,00	910,00

IMBALLI • PACKAGES • EMBALLAGES • FORMATE

	SCATOLA • BOX • BOITE • KARTON			PALLET • PALLETS • PALETTS • PALETTE		
	pz	mq	kg	box	mq	kg
26,5x180	3	1,43	33,30	36	51,48	1.200,00
30x120	4	1,44	31,50	24	34,56	775,00
20x120	4	0,96	21,10	48	46,08	1.030,00
10x60	12	0,72	16,00	60	43,20	985,00
10x53,7	12	0,65	14,80	60	39,00	910,00



201224
BIARRITZ RETTIFICATO 26,5x180
Cod. **111** □



301256
BIARRITZ RETTIFICATO 30x120
Cod. **92** □



201227
BIARRITZ RETTIFICATO 20x120
Cod. **92** □

201230
BIARRITZ RETTIFICATO R11 20x120
Cod. **95** □



106036
BIARRITZ RETTIFICATO 10x60
Cod. **83** □



490733
BIARRITZ MOSAICO MURETTO
2x10 SU RETE 20x40
Cod. **125** ○



10,20 kg



106029
BIARRITZ CHEVRON
RETTIFICATO 10x53,7
Cod. **112** □

IMBALLI • PACKAGES • EMBALLAGES • FORMATE

	SCATOLA • BOX • BOITE • KARTON			PALLET • PALLETS • PALETTS • PALETTE		
	<i>pz</i>	<i>mq</i>	<i>kg</i>	<i>box</i>	<i>mq</i>	<i>kg</i>
26,5x180	3	1,43	33,30	36	51,48	1.200,00
30x120	4	1,44	31,50	24	34,56	775,00
20x120	4	0,96	21,10	48	46,08	1.030,00
10x60	12	0,72	16,00	60	43,20	985,00
10x53,7	12	0,65	14,80	60	39,00	910,00



301260
ST. TROPEZ 2CM RETTIFICATO 30x120
Cod. **139** □

20 mm



301261
ANTIBES 2CM RETTIFICATO 30x120
Cod. **139** □

20 mm



301259
BIARRITZ 2CM RETTIFICATO 30x120
Cod. **139** □

20 mm

IMBALLI • PACKAGES • EMBALLAGES • FORMATE

	SCATOLA • BOX • BOITE • KARTON			PALLET • PALLETS • PALETTS • PALETTE		
	<i>pz</i>	<i>mq</i>	<i>kg</i>	<i>box</i>	<i>mq</i>	<i>kg</i>
30x120 (20mm)	2	0,72	31,50	24	17,28	775,00

Pezzi speciali • Special trims • Pièces spéciales • Formstücke

Battiscopa

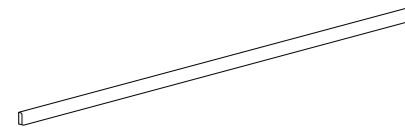

290789
ST. TROPEZ BATTISCOPA RETTIFICATO
5x120
Cod. **33** △

290790
ANTIBES BATTISCOPA RETTIFICATO
5x120
Cod. **33** △

290788
BIARRITZ BATTISCOPA RETTIFICATO
5x120
Cod. **33** △

Gradino

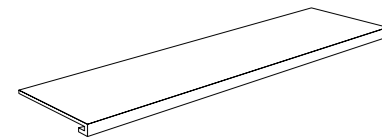

490737
ST. TROPEZ GRADINO
RETTIFICATO 30x120
Cod. **114** ○

490738
ANTIBES GRADINO
RETTIFICATO 30x120
Cod. **114** ○

490736
BIARRITZ GRADINO
RETTIFICATO 30x120
Cod. **114** ○

Angolare

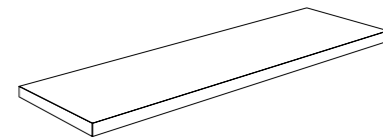

490740
ST. TROPEZ ANGOLARE
RETTIFICATO 30x120
Cod. **110** ○

490741
ANTIBES ANGOLARE
RETTIFICATO 30x120
Cod. **110** ○

490739
BIARRITZ ANGOLARE
RETTIFICATO 30x120
Cod. **110** ○

CARATTERISTICHE DI QUALITÀ Quality characteristics Caractéristiques de qualité Qualitätseigenschaften	NORMA Norm Norme Norme	REQUISITO NORMA Required standards Valeur prescrite selon la norme Normvorgabe	RISULTATO Result Résultat Ergebniss
Assorbimento d'acqua Water absorption of the body Absorption d'eau de support Wasseraufnahme des Scherbens	ISO 10545-3	≤ 0,5	Conforme Conformity Conforme Gemäss
Resistenza a flessione Breaking strenght Résistance à la flexion Biegefestigkeit	ISO 10545-4	≥ 35 N/mm ²	Conforme Conformity Conforme Gemäss
Resistenza all'abrasione Abrasion resistance Resistance a l'abrasion Abriebbeständigkeit	EN ISO 10545-7		PEI IV
Resistenza al gelo Frost resistance Résistance au gel Frostbeständigkeit	ISO 10545-12	Nessun campione deve presentare rotture o alterazioni apprezzabili alla superficie No samples must show ruptures or noticeable surface alteration Aucuns enchantions doit présenter ruptures ou altérations appréciables de la surface Keines der Muster sollte Risse oder sichtbare Fehler der Oberfläche zeigen	Conforme Conformity Conforme Gemäss
Resistenza all'attacco chimico Chemical resistance Résistance à l'attaque chimique Beständigkeit gegen chemikalien	ISO 10545-13	Nessun campione deve presentare alterazioni visibili all'attacco chimico No samples must show visible signs of chemical attack Aucuns enchantions doit présenter des altérations visibles à l'attaque chimique Keines der Muster sollte sehenswerte Aenderungen nach Behandlung mit Chemikalien zeigen	Conforme Conformity Conforme Gemäss
Resistenza agli sbalzi termici Thermal shock resistance Resistance aux ecarts de température Temperaturwechselbeständigkeit	ISO 10545-5		Conforme Conformity Conforme Gemäss
Resistenza scivolosità Sliding resistance Resistance au glissement Rutschfestigkeit	DIN 51130 R	Versione 10 mm 30x120cm 20mm 20x120cm 10mm R11	R10 R11
Resistenza scivolosità Sliding resistance Resistance au glissement Rutschfestigkeit	DIN 51097 (A+B+C)	Versione 10 mm 30x120cm 20mm 20x120cm 10mm R11	A+B A+B+C
Coefficiente d'attrito dinamico Wet dynamic coefficient of friction Coefficient de friction dynamique Reibungskoeffizient Schlupfgrigkeit (in Bewegung)	Bot 3000 E	DCOF ≥ 0,42	> 0,42
Lieve variazione Slight variation Légère variation Geringe Abweichung			V2

V1
Aspetto uniforme
Uniform appearance
Aspect uniforme
Einheitliches Aussehen

V2
Lieve variazione
Slight variation
Légère variation
Geringe Abweichung

V3
Moderata variazione
Moderate variation
Variation modérée
Mäßige Abweichung

V4
Forte stonizzazione
Substantial variation
Effet dénuancé très accentué
Akzentuierte Variation



Tipologia
Type
Typologie
Typ
Gres porcellanato tutta massa
Through-body porcelain
Grès cérame dans la masse
Vollmassiges Feinsteinzeug

Formati
Sizes
Formats
Formate
60x120
30x120
60x60
30x60
30x30
10x30
7,5x15

Spessore
Thickness
Épaisseur
Stärke
10 mm

Resistenza scivolosità
Sliding resistance
Resistance au glissement
Rutschfestigkeit
R10 / A+B

Grado di variazione cromatica
Degree of colour change
Degré de variation chromatique
Grad der Farbabweichung
V2



601227
LOOK WHITE
RETTIFICATO 60x120
Cod. **99** □



490272
LOOK WHITE
RETTIFICATO 30x60
Cod. **80** □



606076
LOOK WHITE
RETTIFICATO 60x60
Cod. **88** □



301201
LOOK WHITE
RETTIFICATO 30x120
Cod. **111** □

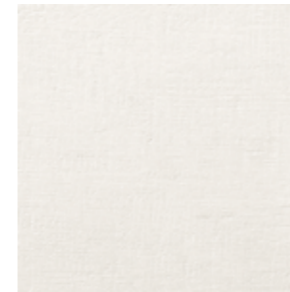

040731
LOOK WHITE
RETTIFICATO 30x30
Cod. **89** □

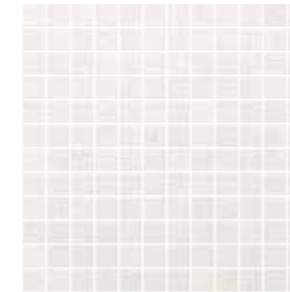

501101
LOOK WHITE MOSAICO
2,4x2,4 SU RETE 30x30
Cod. **132** ○



19,60 kg



501097
LOOK WHITE FRAME
2,8x5,8 SU RETE 30x30
Cod. **31** ○



19,60 kg

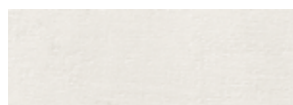

103017
LOOK WHITE
RETTIFICATO 10x30
Cod. **77** □



310175
LOOK WHITE
LONDON 4x30
Cod. **33** ○



6,48 kg



040735
LOOK WHITE SFUSO 7,5x15
Cod. **95** □



490284
LOOK WHITE MOSAICO SLIDE 29x60
Cod. **81** ○



15,27 kg



040755
LOOK WHITE 5x5 SU RETE 30x30
Cod. **24** ○



18,81 kg

IMBALLI • PACKAGES • EMBALLAGES • FORMATE

	SCATOLA • BOX • BOITE • KARTON			PALLET • PALLETS • PALETTS • PALETTE		
	pz	mq	kg	box	mq	kg
60x120	2	1,44	35,30	30	43,20	1.030,00
30x120	3	1,08	26,50	42	45,36	1.015,00
60x60	3	1,08	24,00	40	43,20	960,00
30x60	6	1,08	25,30	40	43,20	1.012,00
30x30	11	0,99	23,00	46	45,54	1.058,00
10x30	20	0,60	14,00	60	36,00	920,00
7,5x15	50	0,56	11,30	60	33,60	678,00



601224
LOOK GRAY
RETTIFICATO 60x120
Cod. **99** □



490273
LOOK GRAY
RETTIFICATO 30x60
Cod. **80** □

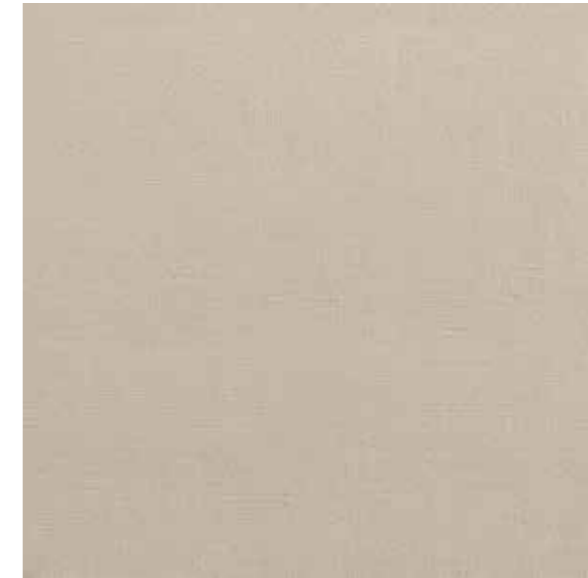

606077
LOOK GRAY
RETTIFICATO 60x60
Cod. **88** □



301202
LOOK GRAY
RETTIFICATO 30x120
Cod. **111** □



040732
LOOK GRAY
RETTIFICATO 30x30
Cod. **89** □

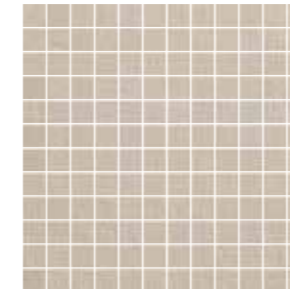

501102
LOOK GRAY MOSAICO
2,4x2,4 SU RETE 30x30
Cod. **132** ○



19,60 kg

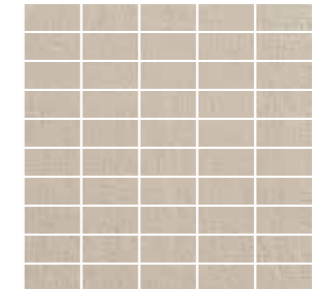

501098
LOOK GRAY FRAME
2,8x5,8 SU RETE 30x30
Cod. **31** ○



19,60 kg

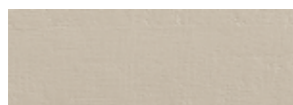

103018
LOOK GRAY
RETTIFICATO 10x30
Cod. **77** □



310176
LOOK GRAY
LONDON 4x30
Cod. **33** ○



6,48 kg



040736
LOOK GRAY SFUSO 7,5x15
Cod. **95** ○

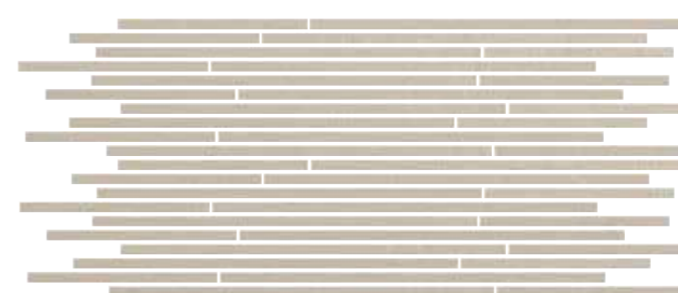

490285
LOOK GRAY MOSAICO SLIDE 29x60
Cod. **81** ○



15,27 kg

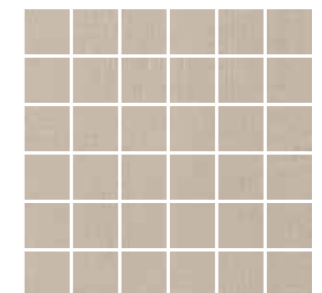

040753
LOOK GRAY 5x5 SU RETE 30x30
Cod. **24** ○



18,81 kg

IMBALLI • PACKAGES • EMBALLAGES • FORMATE

	SCATOLA • BOX • BOITE • KARTON			PALLET • PALLETS • PALETTS • PALETTE		
	pz	mq	kg	box	mq	kg
60x120	2	1,44	35,30	30	43,20	1.030,00
30x120	3	1,08	26,50	42	45,36	1.015,00
60x60	3	1,08	24,00	40	43,20	960,00
30x60	6	1,08	25,30	40	43,20	1.012,00
30x30	11	0,99	23,00	46	45,54	1.058,00
10x30	20	0,60	14,00	60	36,00	920,00
7,5x15	50	0,56	11,30	60	33,60	678,00

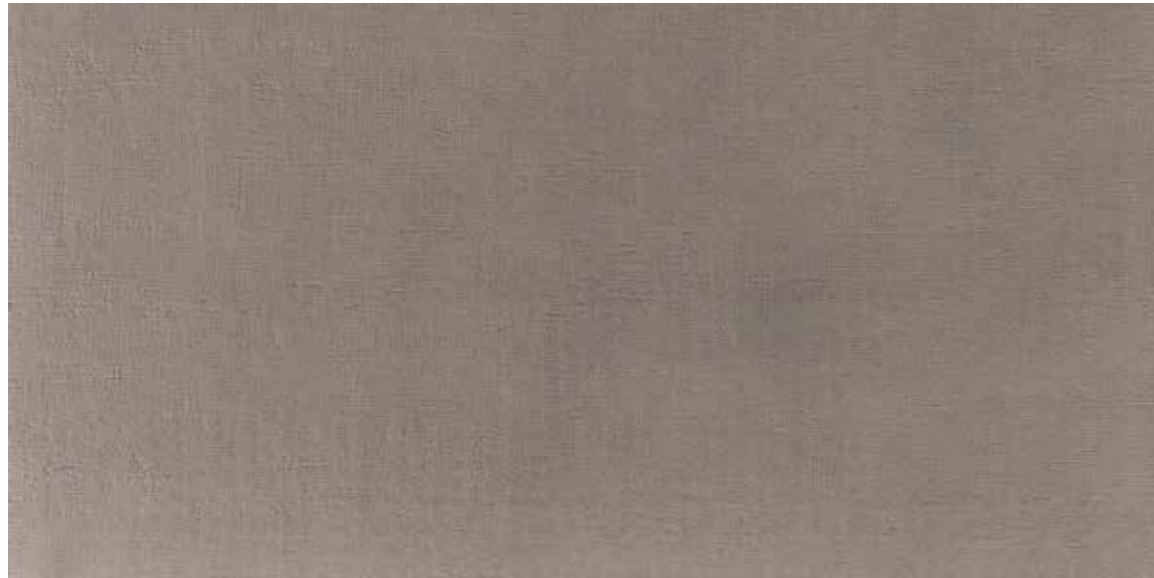

601217
LOOK DARK
RETTIFICATO 60x120
Cod. **99** □



490274
LOOK DARK
RETTIFICATO 30x60
Cod. **80** □

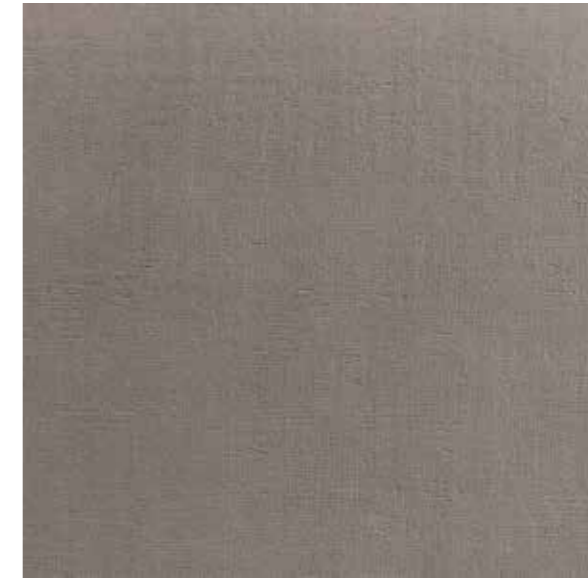

606078
LOOK DARK
RETTIFICATO 60x60
Cod. **88** □



301203
LOOK DARK
RETTIFICATO 30x120
Cod. **111** □



040733
LOOK DARK
RETTIFICATO 30x30
Cod. **89** □

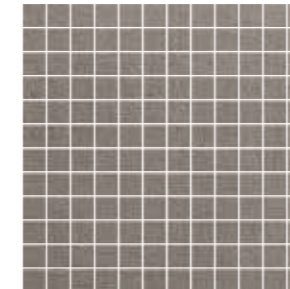

501103
LOOK DARK MOSAICO
2,4x2,4 SU RETE 30x30
Cod. **132** ○



19,60 kg

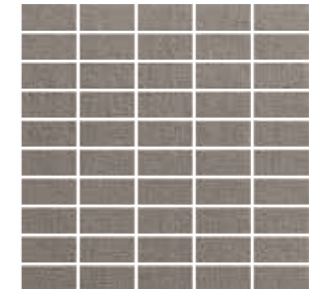

501099
LOOK DARK FRAME
2,8x5,8 SU RETE 30x30
Cod. **31** ○



19,60 kg



103019
LOOK DARK
RETTIFICATO 10x30
Cod. **77** □



310177
LOOK DARK
LONDON 4x30
Cod. **33** ○



6,48 kg



040737
LOOK DARK SFUSO 7,5x15
Cod. **95** □

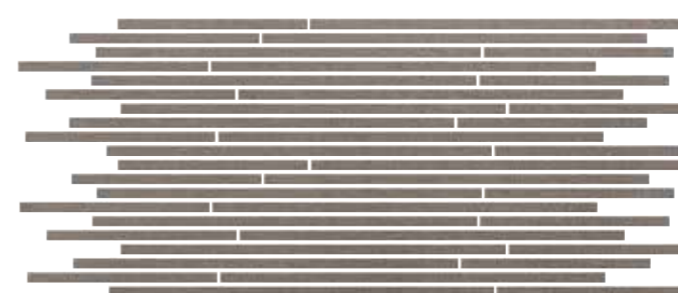

490286
LOOK DARK MOSAICO SLIDE 29x60
Cod. **81** ○



15,27 kg

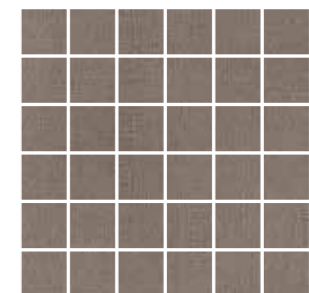

040752
LOOK DARK 5x5 SU RETE 30x30
Cod. **24** ○



18,81 kg

IMBALLI • PACKAGES • EMBALLAGES • FORMATE

	SCATOLA • BOX • BOITE • KARTON			PALLET • PALLETS • PALETTS • PALETTE		
	pz	mq	kg	box	mq	kg
60x120	2	1,44	35,30	30	43,20	1.030,00
30x120	3	1,08	26,50	42	45,36	1.015,00
60x60	3	1,08	24,00	40	43,20	960,00
30x60	6	1,08	25,30	40	43,20	1.012,00
30x30	11	0,99	23,00	46	45,54	1.058,00
10x30	20	0,60	14,00	60	36,00	920,00
7,5x15	50	0,56	11,30	60	33,60	678,00

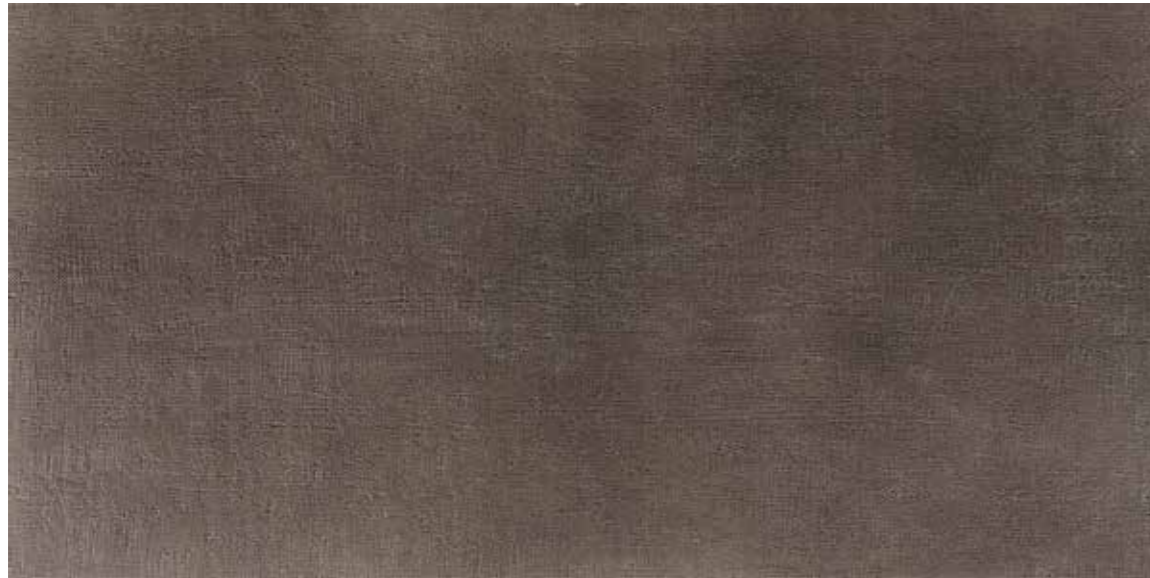

601225
LOOK MUD
RETTIFICATO 60x120
Cod. **99** □



490275
LOOK MUD
RETTIFICATO 30x60
Cod. **80** □

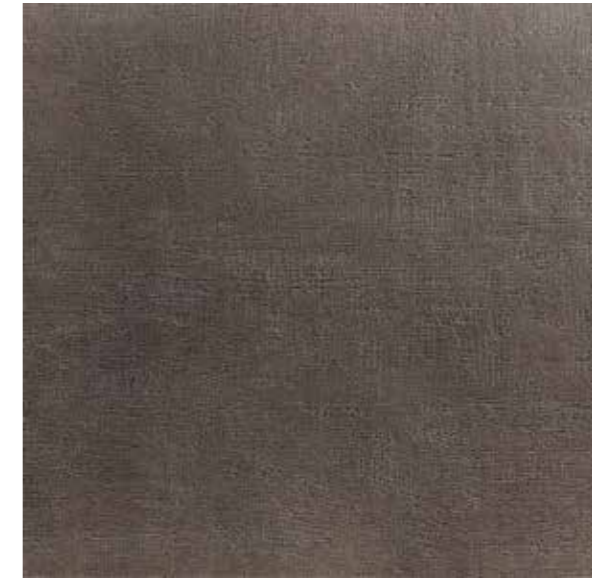

606079
LOOK MUD
RETTIFICATO 60x60
Cod. **88** □



301204
LOOK MUD
RETTIFICATO 30x120
Cod. **111** □



040734
LOOK MUD
RETTIFICATO 30x30
Cod. **89** □

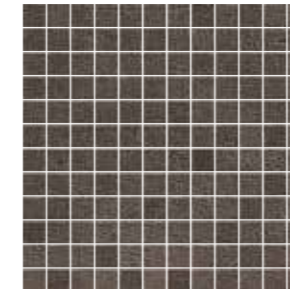

501104
LOOK MUD MOSAICO
2,4x2,4 SU RETE 30x30
Cod. **132** ○



19,60 kg

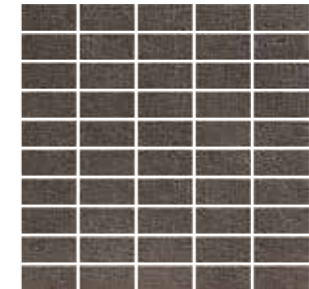

501100
LOOK MUD FRAME
2,8x5,8 SU RETE 30x30
Cod. **31** ○



19,60 kg



103020
LOOK MUD
RETTIFICATO 10x30
Cod. **77** □



310178
LOOK MUD
LONDON 4x30
Cod. **33** ○



6,48 kg



040738
LOOK MUD SFUSO 7,5x15
Cod. **95** □

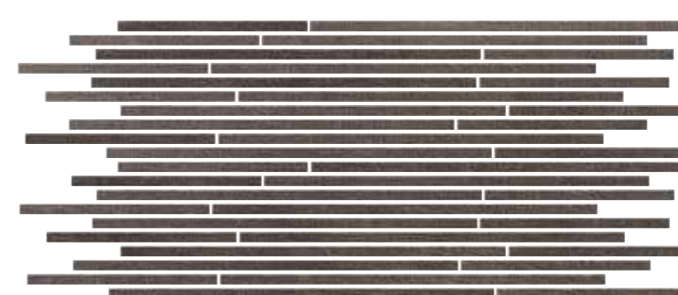

490287
LOOK MUD MOSAICO SLIDE 29x60
Cod. **81** ○



15,27 kg

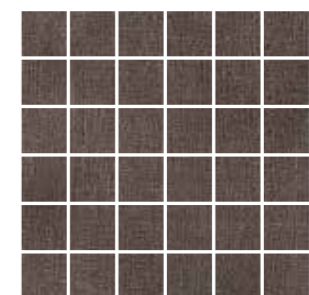

040754
LOOK MUD 5x5 SU RETE 30x30
Cod. **24** ○











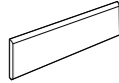
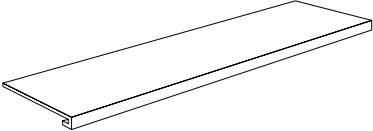
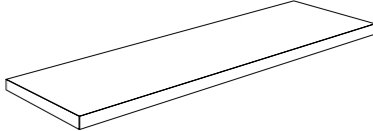
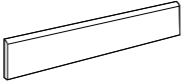
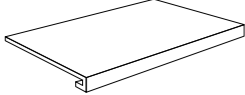
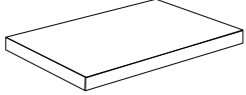

18,81 kg

IMBALLI • PACKAGES • EMBALLAGES • FORMATE

	SCATOLA • BOX • BOITE • KARTON			PALLET • PALLETS • PALETTS • PALETTE		
	pz	mq	kg	box	mq	kg
60x120	2	1,44	35,30	30	43,20	1.030,00
30x120	3	1,08	26,50	42	45,36	1.015,00
60x60	3	1,08	24,00	40	43,20	960,00
30x60	6	1,08	25,30	40	43,20	1.012,00
30x30	11	0,99	23,00	46	45,54	1.058,00
10x30	20	0,60	14,00	60	36,00	920,00
7,5x15	50	0,56	11,30	60	33,60	678,00

Pezzi speciali • Special trims • Pièces spéciales • Formstücke

Battiscopa		Gradino		Angolare	
44 23,32 kg		2 19,00 kg		2 19,00 kg	
	290488 LOOK WHITE BATTISCOPA 7x30 Cod. 116 △		490276 LOOK WHITE GRADINO 33x120 Cod. 114 ○		490280 LOOK WHITE ANGOLARE 33x120 Cod. 110 ○
	290489 LOOK GRAY BATTISCOPA 7x30 Cod. 116 △		490277 LOOK GRAY GRADINO 33x120 Cod. 114 ○		490281 LOOK GRAY ANGOLARE 33x120 Cod. 110 ○
	290490 LOOK DARK BATTISCOPA 7x30 Cod. 116 △		490278 LOOK DARK GRADINO 33x120 Cod. 114 ○		490282 LOOK DARK ANGOLARE 33x120 Cod. 110 ○
	290491 LOOK MUD BATTISCOPA 7x30 Cod. 116 △		490279 LOOK MUD GRADINO 33x120 Cod. 114 ○		490283 LOOK MUD ANGOLARE 33x120 Cod. 110 ○
	290484 LOOK WHITE BATTISCOPA 7x60 Cod. 121 △				
	290485 LOOK GRAY BATTISCOPA 7x60 Cod. 121 △				
	290486 LOOK DARK BATTISCOPA 7x60 Cod. 121 △				
	290487 LOOK MUD BATTISCOPA 7x60 Cod. 121 △				
9,50 kg		2 9,80 kg			
	490333 LOOK WHITE GRADINO 33x60 Cod. 112 ○		490337 LOOK WHITE ANGOLARE 33x60 Cod. 107 ○		
	490331 LOOK GRAY GRADINO 33x60 Cod. 112 ○		490335 LOOK GRAY ANGOLARE 33x60 Cod. 107 ○		
	490330 LOOK DARK GRADINO 33x60 Cod. 112 ○		490334 LOOK DARK ANGOLARE 33x60 Cod. 107 ○		
	490332 LOOK MUD GRADINO 33x60 Cod. 112 ○		490336 LOOK MUD ANGOLARE 33x60 Cod. 107 ○		

CARATTERISTICHE DI QUALITÀ Quality characteristics Caractéristiques de qualité Qualitätseigenschaften	NORMA Norm Norme Norme	REQUISITO NORMA Required standards Valeur prescrite selon la norme Normvorgabe	RISULTATO Result Résultat Ergebniss
 Assorbimento d'acqua Water absorption of the body Absorption d'eau de support Wasseraufnahme des Scherbens	ISO 10545-3	≤ 0,5	Conforme Conformity Conforme Gemäss
 Resistenza a flessione Breaking strenght Résistance à la flexion Biegefestigkeit	ISO 10545-4	≥ 35 N/mm ²	Conforme Conformity Conforme Gemäss
 Resistenza al gelo Frost resistance Résistance au gel Frostbeständigkeit	ISO 10545-12	Nessun campione deve presentare rotture o alterazioni apprezzabili alla superficie No samples must show ruptures or noticeable surface alteration Aucuns enchantions doit présenter ruptures ou altérations appréciables de la surface Keines der Muster sollte Risse oder sichtbare Fehler der Oberfläche zeigen	Conforme Conformity Conforme Gemäss
 Resistenza all'attacco chimico Chemical resistance Résistance à l'attaque chimique Beständigkeit gegen chemikalien	ISO 10545-13		GA GLA
 Resistenza agli sbalzi termici Thermal shock resistance Résistance aux écarts de température Temperaturwechselbeständigkeit	ISO 10545-5		Conforme Conformity Conforme Gemäss
 Resistenza scivolosità Sliding resistance Résistance au glissement Rutschfestigkeit	DIN 51130 R		R10
 Resistenza scivolosità Sliding resistance Résistance au glissement Rutschfestigkeit	DIN 51097 (A+B+C)		A+B
 Coefficiente d'attrito dinamico Wet dynamic coefficient of friction Coefficient de friction dynamique Reibungskoeffizient Schlupfrigkeit (in Bewegung)	Bot 3000 E	DCOF ≥ 0,42	> 0,42
 Lieve variazione Slight variation Légère variation Geringe Abweichung			V2

 **V1**
Aspetto uniforme
Uniform appearance
Aspect uniforme
Einheitliches Aussehen

 **V2**
Lieve variazione
Slight variation
Légère variation
Geringe Abweichung

 **V3**
Moderata variazione
Moderate variation
Variation modérée
Mäßige Abweichung

 **V4**
Forte stonizzazione
Substantial variation
Effet dénuancé très accentué
Akzentuierte Variation



Tipologia
Type
Typologie
Typ
Gres porcellanato smaltato
Glazed porcelain
Grès cérame emaille
Feinsteinzeug glasiert

Formati
Sizes
Formats
Formate
60x120
60x60
30x60
30x30
10x30

Spessore
Thickness
Épaisseur
Stärke
10 mm

Resistenza scivolosità
Sliding resistance
Resistance au glissement
Rutschfestigkeit
R9

Grado di variazione cromatica
Degree of colour change
Degré de variation chromatique
Grad der Farbabweichung
V3



601264
LUXURY GREY NATURALE
RETTIFICATO 60x120
Cod. **94** □

601265
LUXURY GREY LAPPATO
RETTIFICATO 60x120
Cod. **103** □



606201
LUXURY GREY NATURALE
RETTIFICATO 60x60
Cod. **79** □

606203
LUXURY GREY LAPPATO
RETTIFICATO 60x60
Cod. **93** □



490559
LUXURY GREY NATURALE
RETTIFICATO 30x60
Cod. **76** □

490561
LUXURY GREY LAPPATO
RETTIFICATO 30x60
Cod. **85** □

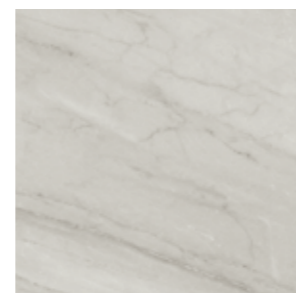

040918
LUXURY GREY NATURALE RETTIFICATO 30x30
Cod. **78** □

040922
LUXURY GREY LAPPATO RETTIFICATO 30x30
Cod. **90** □



103102
LUXURY GREY NATURALE
RETTIFICATO 10x30
Cod. **77** □

103105
LUXURY GREY LAPPATO
RETTIFICATO 10x30
Cod. **93** □



11,40 kg

041119
LUXURY GREY NATURALE
MOSAICO 5x5 SU RETE 30x30
Cod. **24** ○

041130
LUXURY GREY LAPPATO
MOSAICO 5x5 SU RETE 30x30
Cod. **31** ○



10,30 kg

041122
LUXURY GREY NATURALE
MOSAICO INTARSIO 30x30
Cod. **31** ○

041133
LUXURY GREY LAPPATO
MOSAICO INTARSIO 30x30
Cod. **35** ○



13,20 kg

041124
LUXURY GREY NATURALE
MOSAICO HB 28x32
Cod. **45** ○

041132
LUXURY GREY LAPPATO
MOSAICO HB 28x32
Cod. **48** ○



10,30 kg

041120
LUXURY GREY NATURALE
MURETTO 2,4x10 SU RETE 30x30
Cod. **46** ○

041131
LUXURY GREY LAPPATO
MURETTO 2,4x10 SU RETE 30x30
Cod. **58** ○



10,30 kg

041121
LUXURY GREY NATURALE
MOSAICO ESAGONO 27x28
Cod. **136** ○

041129
LUXURY GREY LAPPATO
MOSAICO ESAGONO 27x28
Cod. **49** ○



12,00 kg

041171
LUXURY GREY NATURALE
MOSAICO ARABESQUE SU RETE 30x30
Cod. **57** ○

041172
LUXURY GREY LAPPATO
MOSAICO ARABESQUE SU RETE 30x30
Cod. **72** ○

IMBALLI • PACKAGES • EMBALLAGES • FORMATE

	SCATOLA • BOX • BOITE • KARTON			PALLET • PALLETS • PALETTS • PALETTE		
	pz	mq	kg	box	mq	kg
60x120	2	1,44	33,00	30	43,20	1.010,00
60x60	3	1,08	24,10	40	43,20	980,00
30x60	6	1,08	24,48	40	43,20	980,00
30x30	11	0,99	23,20	46	45,54	1.070,00
10x30	20	0,60	15,00	60	36,00	920,00



3,22 kg

380266
LUXURY GREY NATURALE
LONDON 5x30
Cod. **33** ○

380267
LUXURY GREY LUCIDO
LONDON 5x30
Cod. **33** ○



luxury grey RETT. LAPPATO

La finitura lappata è consigliata per uso rivestimento o per pavimenti da bagno in ambito residenziale. Nello specifico il tipo di pavimentazione deve essere non soggetta ad eccessive sollecitazioni e mai a diretto contatto con aree esterne. Come si verifica comunemente nelle pietre naturali l'eventuale presenza di puntini sulla superficie o di qualche disuniformità della lucentezza sono da considerare caratteristiche del prodotto derivanti dalla lavorazione a cui viene sottoposto.

The polished finish is recommended for wall coverings or for the floors of residential bathrooms. Specifically, floor coverings in this material must not be subjected to excessively heavy traffic and must never be in direct contact with outdoor areas. As is often the case with natural stones, any spots on the surface or any unevenness in shine are typical characteristics of the product, deriving from the process used.

La finitura polie est recommandée pour le revêtement sol et mur des salles de bains résidentielles. Notamment, ce type de carreau au sol ne doit pas être exposé à des contraintes excessives, et il ne doit jamais être en contact direct avec des zones extérieures. Comme cela est souvent le cas pour les pierres naturelles, les micro trous éventuellement présents à la surface du produit ou l'hétérogénéité de son éclat forment des caractéristiques propres au façonnage.

Die polierte Oberfläche wird für Wandverkleidungen und Bodenbeläge in Privatbädern empfohlen. Der Bodenbelag darf keinen starken Beanspruchungen ausgesetzt sein und keinen direkten Kontakt zu Außenbereichen haben. Wie bei Natursteinen üblich, kann die Oberfläche Körnungen oder einen unregelmäßigen Glanz aufweisen. Diese Merkmale sind typische, beabsichtigte Produkteigenschaften, die durch das Bearbeitungsverfahren hervorgerufen werden.

Pezzi speciali • Special trims • Pièces spéciales • Formstücke

Battiscopa



23,60 kg

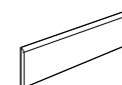

290709
LUXURY GREY NATURALE
BATTISCOPIA 7x30
Cod. **116** △

290710
LUXURY GREY LAPPATO
BATTISCOPIA 7x30
Cod. **22** △

CARATTERISTICHE DI QUALITÀ Quality characteristics Caractéristiques de qualité Qualitätseigenschaften	NORMA Norm Norme Norme	REQUISITO NORMA Required standards Valeur prescrite selon la norme Normvorgabe	RISULTATO Result Résultat Ergebnis
Assorbimento d'acqua Water absorption of the body Absorption d'eau de support Wasseraufnahme des Scherbens	ISO 10545-3	≤ 0,5	Conforme Conformity Conforme Gemäss
Resistenza a flessione Breaking strenght Résistance à la flexion Biegefestigkeit	ISO 10545-4	≥ 35 N/mm ²	Conforme Conformity Conforme Gemäss
Resistenza all'abrasione Abrasion resistance Resistance a l'abrasion Abriebbeständigkeit	ISO 10545-7	Luxury Grey Rettificato Luxury Grey Lappato	PEI IV
Resistenza al gelo Frost resistance Résistance au gel Frostbeständigkeit	ISO 10545-12	Nessun campione deve presentare rotture o alterazioni apprezzabili alla superficie No samples must show ruptures or noticeable surface alteration Aucuns enchantions doit présenter ruptures ou altérations appréciables de la surface Keines der Muster sollte Risse oder sichtbare Fehler der Oberflaeche zeigen	Conforme Conformity Conforme Gemäss
Resistenza all'attacco chimico Chemical resistance Résistance à l'attaque chimique Beständigkeit gegen chemikalien	ISO 10545-13	Luxury Grey Rettificato Luxury Grey Lappato	GA GLA GA GLB
Resistenza agli sbalzi termici Thermal shock resistance Resistance aux écarts de température Temperaturwechselbeständigkeit	ISO 10545-5		Conforme Conformity Conforme Gemäss
Resistenza scivolosità Sliding resistance Resistance au glissement Rutschfestigkeit	DIN 51130 R	Luxury Grey Rettificato Luxury Grey Lappato	R9
Moderata variazione Moderate variation Variation modérée Mäßige Abweichung			V3

Aspetto uniforme
Uniform appearance
Aspect uniforme
Einheitliches Aussehen
V1

Lieve variazione
Slight variation
Légère variation
Geringe Abweichung
V2

Moderata variazione
Moderate variation
Variation modérée
Mäßige Abweichung
V3

Forte stonizzazione
Substantial variation
Effet dénuancé très accentué
Akzentuierte Variation
V4

PER UNA POSA OTTIMALE DEL PRODOTTO CONSIGLIAMO SEMPRE DI MESCOLARE ALMENO TRE SCATOLE DI MATERIALE.

For the best product laying results, material from at least three boxes should be mixed.

Pour une pose excellente, nous recommandons toujours de mélanger le contenu d'au moins trois boîtes.

Für eine optimale Verlegung des Erzeugnisses empfehlen wir stets, mindestens drei Packungen Material anzumischen.



Tipologia
Type
Typologie
Typ
Gres porcellanato smaltato
Glazed porcelain
Grès cérame emaille
Feinsteinzeug glasiert

Formati
Sizes
Formats
Formate
60x60
30x60
15x60
30x30
10x30
15x15
7,5x15
10x10

Spessore
Thickness
Épaisseur
Stärke
10 mm

Resistenza scivolosità
Sliding resistance
Resistance au glissement
Rutschfestigkeit
R9

Grado di variazione cromatica
Degree of colour change
Degré de variation chromatique
Grad der Farbabweichung
V3



606126
MARMOBIANCO NATURALE RETTIFICATO 60x60
Cod. **79** □

606127
MARMOBIANCO LAPPATO RETTIFICATO 60x60
Cod. **93** □



490364
MARMOBIANCO NATURALE RETTIFICATO 30x60
Cod. **76** □

490365
MARMOBIANCO LAPPATO RETTIFICATO 30x60
Cod. **85** □



550098
MARMOBIANCO NATURALE RETTIFICATO 15x60
Cod. **76** □

550099
MARMOBIANCO LAPPATO RETTIFICATO 15x60
Cod. **85** □



230234
MARMOBIANCO NATURALE
RETTIFICATO 15x15
Cod. **78** □

230235
MARMOBIANCO LAPPATO
RETTIFICATO 15x15
Cod. **90** □

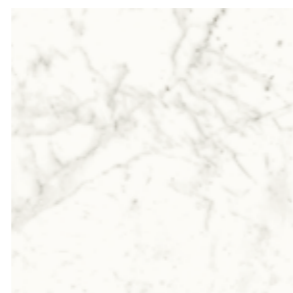

040832
MARMOBIANCO NATURALE RETTIFICATO 30x30
Cod. **78** □

040833
MARMOBIANCO LAPPATO RETTIFICATO 30x30
Cod. **90** □

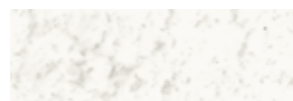

103048
MARMOBIANCO NATURALE RETTIFICATO 10x30
Cod. **95** □

103049
MARMOBIANCO LAPPATO RETTIFICATO 10x30
Cod. **111** □



040834
MARMOBIANCO NATURALE SFUSO 7,5x15
Cod. **95** □

040835
MARMOBIANCO LAPPATO SFUSO 7,5x15
Cod. **111** □



450360
MARMOBIANCO NATURALE
SFUSO 10x10
Cod. **90** □

450361
MARMOBIANCO LAPPATO
SFUSO 10x10
Cod. **106** □



040836
MARMOBIANCO NATURALE
MOSAICO 5x5 SU RETE 30x30
Cod. **24** ○

040837
MARMOBIANCO LAPPATO
MOSAICO 5x5 SU RETE 30x30
Cod. **31** ○



040838
MARMOBIANCO NATURALE MOSAICO
MURETTO 2,4x10 SU RETE 30x30
Cod. **46** ○

040839
MARMOBIANCO LAPPATO MOSAICO
MURETTO 2,4x10 SU RETE 30x30
Cod. **58** ○



12,00 kg



040840
MARMOBIANCO NATURALE
BASKETWAVE SU RETE 30x30
Cod. **47** ○

040841
MARMOBIANCO LAPPATO
BASKETWAVE SU RETE 30x30
Cod. **60** ○



040883
MARMOBIANCO NATURALE MOSAICO
ESAGONALE 5x5 SU RETE 27x28
Cod. **136** ○

040884
MARMOBIANCO LAPPATO MOSAICO
ESAGONALE 5x5 SU RETE 27x28
Cod. **49** ○



18,81 kg



6,43 kg

380172
MARMOBIANCO NATURALE NATURALE
LONDON 5x30
Cod. **33** ○

380173
MARMOBIANCO LUCIDO
LONDON 5x30
Cod. **33** ○



4,50 kg

380171
MARMOBIANCO NATURALE BORDURA
MURETTO RETTIFICATO 7x30 SU RETE
Cod. **28** ○

380174
MARMOBIANCO LAPPATO BORDURA
MURETTO 7x30 SU RETE
Cod. **28** ○



4,50 kg

380170
MARMOBIANCO NATURALE BORDURA
HYDRO 7x30 SU RETE
Cod. **123** ○

380175
MARMOBIANCO LAPPATO BORDURA
HYDRO 7x30 SU RETE
Cod. **123** ○

IMBALLI • PACKAGES • EMBALLAGES • FORMATE

	SCATOLA • BOX • BOITE • KARTON			PALLET • PALLETS • PALETTS • PALETTE		
	pz	mq	kg	box	mq	kg
60x60	3	1,08	24,10	40	43,20	980,00
30x60	6	1,08	24,48	40	43,20	1.000,00
15x60	10	0,90	19,60	48	42,20	940,00
30x30	11	0,99	23,20	46	45,54	1.070,00
10x30	20	0,60	15,00	60	36,00	920,00
15x15	46	1,035	20,20	33	34,15	665,00
10x10	50	0,50	8,70	36	18,00	315,00
7,5x15	50	0,56	11,30	76	42,56	858,80



marmobianco RETT. LAPPATO

La finitura lappata è consigliata per uso rivestimento o per pavimenti da bagno in ambito residenziale. Nello specifico il tipo di pavimentazione deve essere non soggetta ad eccessive sollecitazioni e mai a diretto contatto con aree esterne. Come si verifica comunemente nelle pietre naturali l'eventuale presenza di puntini sulla superficie o di qualche disuniformità della lucentezza sono da considerare caratteristiche del prodotto derivanti dalla lavorazione a cui viene sottoposto.





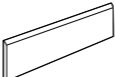

The polished finish is recommended for wall coverings or for the floors of residential bathrooms. Specifically, floor coverings in this material must not be subjected to excessively heavy traffic and must never be in direct contact with outdoor areas. As is often the case with natural stones, any spots on the surface or any unevenness in shine are typical characteristics of the product, deriving from the process used.

La finitura polie est recommandée pour le revêtement sol et mur des salles de bains résidentielles. Notamment, ce type de carreau au sol ne doit pas être exposé à des contraintes excessives, et il ne doit jamais être en contact direct avec des zones extérieures. Comme cela est souvent le cas pour les pierres naturelles, les micro trous éventuellement présents à la surface du produit ou l'hétérogénéité de son éclat forment des caractéristiques propres au façonnage.

Die polierte Oberfläche wird für Wandverkleidungen und Bodenbeläge in Privatbädern empfohlen. Der Bodenbelag darf keinen starken Beanspruchungen ausgesetzt sein und keinen direkten Kontakt zu Außenbereichen haben. Wie bei Natursteinen üblich, kann die Oberfläche Körnungen oder einen unregelmäßigen Glanz aufweisen. Diese Merkmale sind typische, beabsichtigte Produkteigenschaften, die durch das Bearbeitungsverfahren hervorgerufen werden.

Pezzi speciali • Special trims • Pièces spéciales • Formstücke

Battiscopa	44 23,60 kg	18 18,00 kg
	290557 MARMOBIANCO NATURALE BATTISCOPA 7x30 Cod. 116 △	290582 MARMOBIANCO NATURALE BATTISCOPA 7x60 Cod. 121 △
	290558 MARMOBIANCO LAPPATO BATTISCOPA 7x30 Cod. 22 △	290583 MARMOBIANCO LAPPATO BATTISCOPA 7x60 Cod. 26 △

CARATTERISTICHE DI QUALITÀ Quality characteristics Caractéristiques de qualité Qualitätseigenschaften	NORMA Norm Norme Norme	REQUISITO NORMA Required standards Valeur prescrite selon la norme Normvorgabe	RISULTATO Result Résultat Ergebniss
 Assorbimento d'acqua Water absorption of the body Absorption d'eau de support Wasseraufnahme des Scherbens	ISO 10545-3	≤ 0,5	Conforme Conformity Conforme Gemäss
 Resistenza a flessione Breaking strenght Résistance à la flexion Biegefestigkeit	ISO 10545-4	≥ 35 N/mm ²	Conforme Conformity Conforme Gemäss
 Resistenza all'abrasione Abrasion resistance Résistance à l'abrasion Abriebbeständigkeit	ISO 10545-7	Marmobianco Rettificato Marmobianco Lappato	PEI IV
 Resistenza al gelo Frost resistance Résistance au gel Frostbeständigkeit	ISO 10545-12	Nessun campione deve presentare rotture o alterazioni apprezzabili alla superficie No samples must show ruptures or noticeable surface alteration Aucuns enchantions doit présenter ruptures ou altérations appréciables de la surface Keines der Muster sollte Risse oder sichtbare Fehler der Oberfläche zeigen	Conforme Conformity Conforme Gemäss
 Resistenza all'attacco chimico Chemical resistance Résistance à l'attaque chimique Beständigkeit gegen chemikalien	ISO 10545-13	Marmobianco Rettificato Marmobianco Lappato	GA GLA GA GLB
 Resistenza agli sbalzi termici Thermal shock resistance Résistance aux écarts de température Temperaturwechselbeständigkeit	ISO 10545-5		Conforme Conformity Conforme Gemäss
 Resistenza scivolosità Sliding resistance Résistance au glissement Rutschfestigkeit	DIN 51130 R	Marmobianco Rettificato Marmobianco Lappato	R9
 Moderata variazione Moderate variation Variation modérée Mäßige Abweichung			V3

 V1 Aspetto uniforme Uniform appearance Aspect uniforme Einheitliches Aussehen	 V2 Lieve variazione Slight variation Légère variation Geringe Abweichung	 V3 Moderata variazione Moderate variation Variation modérée Mäßige Abweichung	 V4 Forte stonizzazione Substantial variation Effet dénuancé très accentué Akzentuierte Variation
---	--	---	--

PER UNA POSA OTTIMALE DEL PRODOTTO CONSIGLIAMO SEMPRE DI MESCOLARE ALMENO TRE SCATOLE DI MATERIALE.

For the best product laying results, material from at least three boxes should be mixed.

Pour une pose excellente, nous recommandons toujours de mélanger le contenu d'au moins trois boîtes.

Für eine optimale Verlegung des Erzeugnisses empfehlen wir stets, mindestens drei Packungen Material anzumischen.



Tipologia
Type
Typologie
Typ
Gres porcellanato tutta massa
Through-body porcelain
Grès cérame dans la masse
Vollmassiges Feinsteinzeug

Formati
Sizes
Formats
Formate
60x120
60x60
30x60
30x30
10x30

Spessore
Thickness
Épaisseur
Stärke
10 mm

Resistenza scivolosità
Sliding resistance
Resistance au glissement
Rutschfestigkeit
R9

Grado di variazione cromatica
Degree of colour change
Degré de variation chromatique
Grad der Farbabweichung
V2



601258
MARQUINIA BLACK NATURALE
RETTIFICATO 60x120
Cod. **104** □

601259
MARQUINIA BLACK LAPPATO
RETTIFICATO 60x120
Cod. **111** □



606179
MARQUINIA BLACK NATURALE
RETTIFICATO 60x60
Cod. **93** □

606178
MARQUINIA BLACK LAPPATO
RETTIFICATO 60x60
Cod. **106** □



490572
MARQUINIA BLACK NATURALE
RETTIFICATO 30x60
Cod. **85** □

490573
MARQUINIA BLACK LAPPATO
RETTIFICATO 30x60
Cod. **100** □



041054
MARQUINIA BLACK NATURALE RETTIFICATO 30x30
Cod. **91** □

041055
MARQUINIA BLACK LAPPATO RETTIFICATO 30x30
Cod. **104** □



103092
MARQUINIA BLACK NATURALE
RETTIFICATO 10x30
Cod. **111** □

103093
MARQUINIA BLACK LAPPATO
RETTIFICATO 10x30
Cod. **139** □

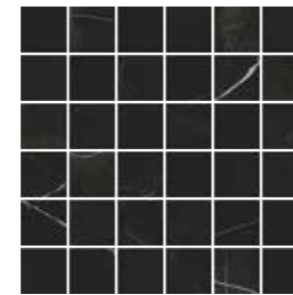

6
12,30 kg

041056
MARQUINIA BLACK NATURALE
MOSAICO 5x5 SU RETE 30x30
Cod. **25** ○

041057
MARQUINIA BLACK LAPPATO
MOSAICO 5x5 SU RETE 30x30
Cod. **34** ○

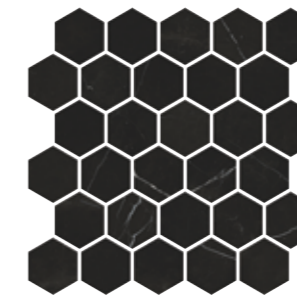

11
18,80 kg

041064
MARQUINIA BLACK NATURALE
MOSAICO ESAGONO SU RETE 27x28
Cod. **47** ○

041065
MARQUINIA BLACK LAPPATO
MOSAICO ESAGONO SU RETE 27x28
Cod. **63** ○



24
6,43 kg

380252
MARQUINIA BLACK NATURALE
LONDON 5x30
Cod. **127** ○

380253
MARQUINIA BLACK LUCIDO
LONDON 5x30
Cod. **127** ○

IMBALLI • PACKAGES • EMBALLAGES • FORMATE

	SCATOLA • BOX • BOITE • KARTON			PALLET • PALLETS • PALETTS • PALETTE		
	pz	mq	kg	box	mq	kg
60x120	2	1,44	32,50	30	43,20	1.000,00
60x60	3	1,08	24,60	40	43,20	1.010,00
30x60	6	1,08	24,70	40	43,20	1.010,00
30x30	11	0,99	22,50	46	45,54	1.060,00
10x30	20	0,60	13,50	60	36,00	920,00



marquinia black RETT. LAPPATO

La finitura lappata è consigliata per uso rivestimento o per pavimenti da bagno in ambito residenziale. Nello specifico il tipo di pavimentazione deve essere non soggetta ad eccessive sollecitazioni e mai a diretto contatto con aree esterne. Come si verifica comunemente nelle pietre naturali l'eventuale presenza di puntini sulla superficie o di qualche disuniformità della lucentezza sono da considerare caratteristiche del prodotto derivanti dalla lavorazione a cui viene sottoposto.

The polished finish is recommended for wall coverings or for the floors of residential bathrooms. Specifically, floor coverings in this material must not be subjected to excessively heavy traffic and must never be in direct contact with outdoor areas. As is often the case with natural stones, any spots on the surface or any unevenness in shine are typical characteristics of the product, deriving from the process used.

La finitura polie est recommandée pour le revêtement sol et mur des salles de bains résidentielles. Notamment, ce type de carreau au sol ne doit pas être exposé à des contraintes excessives, et il ne doit jamais être en contact direct avec des zones extérieures. Comme cela est souvent le cas pour les pierres naturelles, les micro trous éventuellement présents à la surface du produit ou l'hétérogénéité de son éclat forment des caractéristiques propres au façonnage.

Die polierte Oberfläche wird für Wandverkleidungen und Bodenbeläge in Privatbädern empfohlen. Der Bodenbelag darf keinen starken Beanspruchungen ausgesetzt sein und keinen direkten Kontakt zu Außenbereichen haben. Wie bei Natursteinen üblich, kann die Oberfläche Körnungen oder einen unregelmäßigen Glanz aufweisen. Diese Merkmale sind typische, beabsichtigte Produkteigenschaften, die durch das Bearbeitungsverfahren hervorgerufen werden.

Pezzi speciali • Special trims • Pièces spéciales • Formstücke

Battiscopa	 23,60 kg	 23,60 kg	
	290673 MARQUINIA BLACK NATURALE BATTISCOPA 7x30 Cod. 23 △		290674 MARQUINIA BLACK LAPPATO BATTISCOPA 7x30 Cod. 21 △

CARATTERISTICHE DI QUALITÀ Quality characteristics Caractéristiques de qualité Qualitätseigenschaften	NORMA Norm Norme Norme	REQUISITO NORMA Required standards Valeur prescrite selon la norme Normvorgabe	RISULTATO Result Résultat Ergebnis
 Assorbimento d'acqua Water absorption of the body Absorption d'eau de support Wasseraufnahme des Scherbens	ISO 10545-3	≤ 0,5	Conforme Conformity Conforme Gemäss
 Resistenza a flessione Breaking strenght Résistance à la flexion Biegefestigkeit	ISO 10545-4	≥ 35 N/mm ²	Conforme Conformity Conforme Gemäss
 Resistenza all'abrasione Abrasion resistance Resistance a l'abrasion Abriebbeständigkeit	EN ISO 10545-6	≤ 175 mm ³	Conforme
 Resistenza al gelo Frost resistance Résistance au gel Frostbeständigkeit	ISO 10545-12	Nessun campione deve presentare rotture o alterazioni apprezzabili alla superficie No samples must show ruptures or noticeable surface alteration Aucuns enchantions doit présenter ruptures ou altérations appréciables de la surface Keines der Muster sollte Risse oder sichtbare Fehler der Oberflaeche zeigen	Conforme Conformity Conforme Gemäss
 Resistenza all'attacco chimico Chemical resistance Résistance à l'attaque chimique Beständigkeit gegen chemikalien	ISO 10545-13	Marquinia Black Rettificato Marquinia Black Lappato	GA GLB GA GLB
 Resistenza agli sbalzi termici Thermal shock resistance Resistance aux écarts de température Temperaturwechselbeständigkeit	ISO 10545-5		Conforme Conformity Conforme Gemäss
 Resistenza scivolosità Sliding resistance Résistance au glissement Rutschfestigkeit	DIN 51130 R	Marquinia Black Rettificato Marquinia Black Lappato	R9
 Lieve variazione Slight variation Légère variation Geringe Abweichung			V2

 **V1**
Aspetto uniforme
Uniform appearance
Aspect uniforme
Einheitliches Aussehen

 **V2**
Lieve variazione
Slight variation
Légère variation
Geringe Abweichung

 **V3**
Moderata variazione
Moderate variation
Variation modérée
Mäßige Abweichung

 **V4**
Forte stonizzazione
Substantial variation
Effet dénuancé très accentué
Akzentuierte Variation

PER UNA POSA OTTIMALE DEL PRODOTTO CONSIGLIAMO SEMPRE DI MESCOLARE ALMENO TRE SCATOLE DI MATERIALE.

For the best product laying results, material from at least three boxes should be mixed.

Pour une pose excellente, nous recommandons toujours de mélanger le contenu d'au moins trois boîtes.

Für eine optimale Verlegung des Erzeugnisses empfehlen wir stets, mindestens drei Packungen Material anzumischen.



Tipologia
Type
Typologie
Typ
Gres porcellanato smaltato
Glazed porcelain
Grès cérame emaille
Feinsteinzeug glasiert

Formati
Sizes
Formats
Formate
60x60
30x60
30x30
10x30
5x20

Spessore
Thickness
Épaisseur
Stärke
10 mm

Resistenza scivolosità
Sliding resistance
Resistance au glissement
Rutschfestigkeit
R9

Grado di variazione cromatica
Degree of colour change
Degré de variation chromatique
Grad der Farbabweichung
V3



606146
METAL ART BLACK RETTIFICATO 60x60
Cod. **79** □



490507
METAL ART BLACK RETTIFICATO 30x60
Cod. **76** □



040901
METAL ART BLACK RETTIFICATO 30x30
Cod. **78** □



103061
METAL ART BLACK RETTIFICATO 10x30
Cod. **77** □



050201
METAL ART BLACK 5x20 (sfuso)
Cod. **93** □

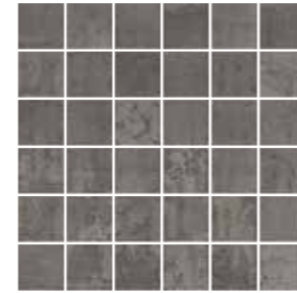

040905
METAL ART BLACK
MOSAICO 5x5 SU RETE 30x30
Cod. **24** ○



12,00 kg

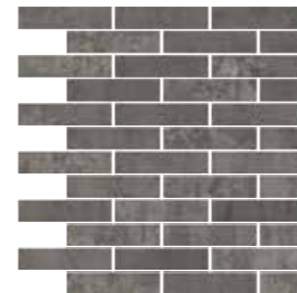

040909
METAL ART BLACK
MURETTO 2,4x10 SU RETE 30x30
Cod. **46** ○



19,00 kg



310188
METAL ART BLACK LONDON 4x30
Cod. **33** ○



6,48 kg

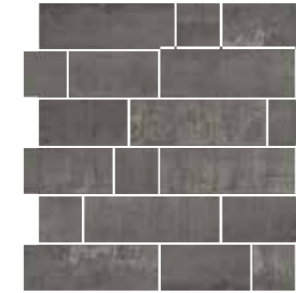

040913
METAL ART BLACK
MOSAICO KIOS 30x30
Cod. **31** ○



21,00 kg



390470
METAL ART ESAGONO INTARSIO GREY / BLACK
10x10 SU RETE 20x35
Cod. **57** ○



6,65 kg

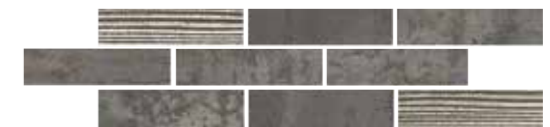

380206
METAL ART BLACK LISTELLO 7,2x30
Cod. **14** ○



4,76 kg

IMBALLI • PACKAGES • EMBALLAGES • FORMATE

	SCATOLA • BOX • BOITE • KARTON			PALLET • PALLETS • PALETTS • PALETTE		
	<i>pz</i>	<i>mq</i>	<i>kg</i>	<i>box</i>	<i>mq</i>	<i>kg</i>
60x60	3	1,08	23,80	40	43,20	950,00
30x60	6	1,08	23,10	40	43,20	950,00
30x30	11	0,99	21,80	46	45,54	1.000,00
10x30	20	0,60	12,60	60	36,00	800,00
5x20	56	0,56	12,30	60	33,60	760,00



606145
METAL ART GREY RETTIFICATO 60x60
Cod. **79** □



490509
METAL ART GREY RETTIFICATO 30x60
Cod. **76** □



040903
METAL ART GREY RETTIFICATO 30x30
Cod. **78** □



103063
METAL ART GREY RETTIFICATO 10x30
Cod. **77** □



050203
METAL ART GREY 5x20 (sfuso)
Cod. **93** □

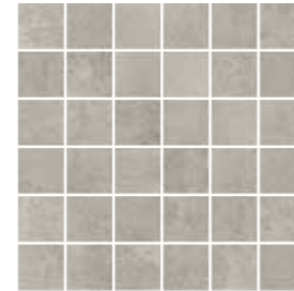

040907
METAL ART GREY
MOSAICO 5x5 SU RETE 30x30
Cod. **24** ○



12,00 kg



040911
METAL ART GREY
MURETTO 2,4x10 SU RETE 30x30
Cod. **46** ○



19,00 kg



310190
METAL ART GREY LONDON 4x30
Cod. **33** ○



6,48 kg



040915
METAL ART GREY
MOSAICO KIOS 30x30
Cod. **31** ○



21,00 kg



390470
METAL ART ESAGONO INTARSIO GREY / BLACK
10x10 SU RETE 20x35
Cod. **57** ○



6,65 kg



380208
METAL ART GREY LISTELLO 7,2x30
Cod. **14** ○



4,76 kg

IMBALLI • PACKAGES • EMBALLAGES • FORMATE

	SCATOLA • BOX • BOITE • KARTON			PALLET • PALLETS • PALETTS • PALETTE		
	pz	mq	kg	box	mq	kg
60x60	3	1,08	23,80	40	43,20	950,00
30x60	6	1,08	23,10	40	43,20	950,00
30x30	11	0,99	21,80	46	45,54	1.000,00
10x30	20	0,60	12,60	60	36,00	800,00
5x20	56	0,56	12,30	60	33,60	760,00



606144
METAL ART IVORY RETTIFICATO 60x60
Cod. **79** □



490508
METAL ART IVORY RETTIFICATO 30x60
Cod. **76** □



040902
METAL ART IVORY RETTIFICATO 30x30
Cod. **78** □



103062
METAL ART IVORY RETTIFICATO 10x30
Cod. **77** □



050202
METAL ART IVORY 5x20 (sfuso)
Cod. **93** □



040906
METAL ART IVORY
MOSAICO 5x5 SU RETE 30x30
Cod. **24** ○



12,00 kg

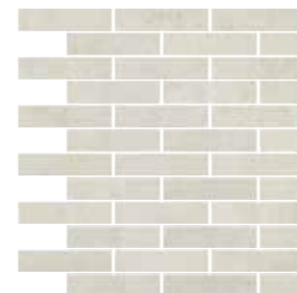

040910
METAL ART IVORY
MURETTO 2,4x10 SU RETE 30x30
Cod. **46** ○



19,00 kg



310189
METAL ART IVORY LONDON 4x30
Cod. **33** ○



6,48 kg



040914
METAL ART IVORY
MOSAICO KIOS 30x30
Cod. **31** ○



21,00 kg



390469
METAL ART ESAGONO INTARSIO IVORY / TAUPE
10x10 SU RETE 20x35
Cod. **57** ○



6,65 kg



380207
METAL ART IVORY LISTELLO 7,2x30
Cod. **14** ○



4,76 kg

IMBALLI • PACKAGES • EMBALLAGES • FORMATE

	SCATOLA • BOX • BOITE • KARTON			PALLET • PALLETS • PALETTS • PALETTE		
	pz	mq	kg	box	mq	kg
60x60	3	1,08	23,80	40	43,20	950,00
30x60	6	1,08	23,10	40	43,20	950,00
30x30	11	0,99	21,80	46	45,54	1.000,00
10x30	20	0,60	12,60	60	36,00	800,00
5x20	56	0,56	12,30	60	33,60	760,00



606147
METAL ART TAUPE RETTIFICATO 60x60
Cod. **79** □



490510
METAL ART TAUPE RETTIFICATO 30x60
Cod. **76** □

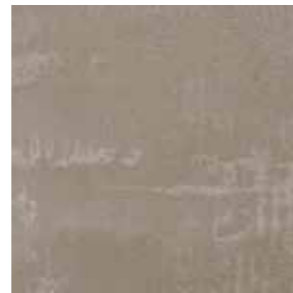

040904
METAL ART TAUPE RETTIFICATO 30x30
Cod. **78** □



103064
METAL ART TAUPE RETTIFICATO 10x30
Cod. **77** □



050204
METAL ART TAUPE 5x20 (sfuso)
Cod. **93** □

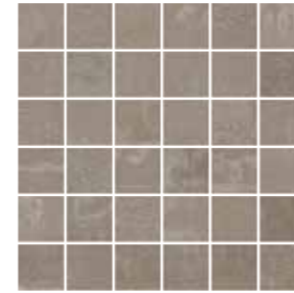

6
12,00 kg

040908
METAL ART TAUPE
MOSAICO 5x5 SU RETE 30x30
Cod. **24** ○

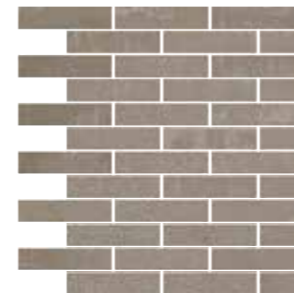

11
19,00 kg

040912
METAL ART TAUPE
MURETTO 2,4x10 SU RETE 30x30
Cod. **46** ○



24
6,48 kg

310191
METAL ART TAUPE LONDON 4x30
Cod. **33** ○

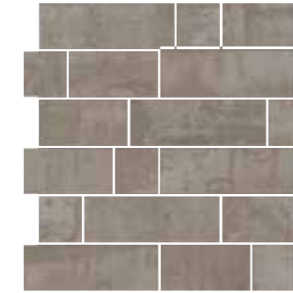

11
21,00 kg

040916
METAL ART TAUPE
MOSAICO KIOS 30x30
Cod. **31** ○



5
6,65 kg

390469
METAL ART ESAGONO INTARSIO IVORY / TAUPE
10x10 SU RETE 20x35
Cod. **57** ○



10
4,76 kg









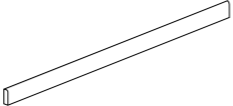
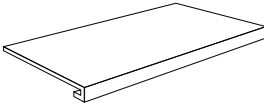
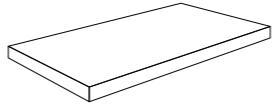



380209
METAL ART TAUPE LISTELLO 7,2x30
Cod. **14** ○

IMBALLI • PACKAGES • EMBALLAGES • FORMATE

	SCATOLA • BOX • BOITE • KARTON			PALLET • PALLETS • PALETTS • PALETTE		
	pz	mq	kg	box	mq	kg
60x60	3	1,08	23,80	40	43,20	950,00
30x60	6	1,08	23,10	40	43,20	950,00
30x30	11	0,99	21,80	46	45,54	1.000,00
10x30	20	0,60	12,60	60	36,00	800,00
5x20	56	0,56	12,30	60	33,60	760,00

Pezzi speciali • Special trims • Pièces spéciales • Formstücke

Battiscopa		Angolare	
40 9,00 kg		20 9,00 kg	
	290593 METAL ART BLACK BATTISCOPIA 5x30 Cod. 116 △		290597 METAL ART BLACK ANGOLARE 33x60 Cod. 121 △
	290595 METAL ART GREY BATTISCOPIA 5x30 Cod. 116 △		290599 METAL ART GREY ANGOLARE 33x60 Cod. 121 △
	290594 METAL ART IVORY BATTISCOPIA 5x30 Cod. 116 △		290598 METAL ART IVORY ANGOLARE 33x60 Cod. 121 △
	290596 METAL ART TAUPE BATTISCOPIA 5x30 Cod. 116 △		290600 METAL ART TAUPE ANGOLARE 33x60 Cod. 121 △
Gradino		Angolare	
2 10,00 kg		2 11,00 kg	
	490479 METAL ART BLACK GRADINO 33x60 Cod. 112 ○		490483 METAL ART BLACK ANGOLARE 33x60 Cod. 107 ○
	490480 METAL ART GREY GRADINO 33x60 Cod. 112 ○		490484 METAL ART GREY ANGOLARE 33x60 Cod. 107 ○
	490481 METAL ART IVORY GRADINO 33x60 Cod. 112 ○		490485 METAL ART IVORY ANGOLARE 33x60 Cod. 107 ○
	490482 METAL ART TAUPE GRADINO 33x60 Cod. 112 ○		490486 METAL ART TAUPE ANGOLARE 33x60 Cod. 107 ○

CARATTERISTICHE DI QUALITÀ Quality characteristics Caractéristiques de qualité Qualitätseigenschaften	NORMA Norm Norme Norme	REQUISITO NORMA Required standards Valeur prescrite selon la norme Normvorgabe	RISULTATO Result Résultat Ergebnis
 Assorbimento d'acqua Water absorption of the body Absorption d'eau de support Wasseraufnahme des Scherbens	ISO 10545-3	≤ 0,5	Conforme Conformity Conforme Gemäss
 Resistenza a flessione Breaking strength Résistance à la flexion Biegefestigkeit	ISO 10545-4	≥ 35 N/mm ²	Conforme Conformity Conforme Gemäss
 Resistenza all'abrasione Abrasion resistance Résistance à l'abrasion Abriebbeständigkeit	EN ISO 10545-7	Grey - Ivory - White Black	PEI V PEI IV
 Resistenza al gelo Frost resistance Résistance au gel Frostbeständigkeit	ISO 10545-12	Nessun campione deve presentare rotture o alterazioni apprezzabili alla superficie No samples must show ruptures or noticeable surface alteration Aucuns enchantions doit présenter ruptures ou altérations appréciables de la surface Keines der Muster sollte Risse oder sichtbare Fehler der Oberfläche zeigen	Conforme Conformity Conforme Gemäss
 Resistenza all'attacco chimico Chemical resistance Résistance à l'attaque chimique Beständigkeit gegen chemikalien	ISO 10545-13		GA GLA
 Resistenza agli sbalzi termici Thermal shock resistance Résistance aux écarts de température Temperaturwechselbeständigkeit	ISO 10545-5		Conforme Conformity Conforme Gemäss
 Resistenza scivolosità Sliding resistance Résistance au glissement Rutschfestigkeit	DIN 51130 R		R9
 Coefficiente d'attrito dinamico Wet dynamic coefficient of friction Coefficient de friction dynamique Reibungskoeffizient Schlupfgrigkeit (in Bewegung)	Bot 3000 E	DCOF ≥ 0,42	> 0,42
 Moderata variazione Moderate variation Variation modérée Mäßige Abweichung			V3
 V1 Aspetto uniforme Uniform appearance Aspect uniforme Einheitliches Aussehen	 V2 Lieve variazione Slight variation Légère variation Geringe Abweichung	 V3 Moderata variazione Moderate variation Variation modérée Mäßige Abweichung	 V4 Forte stonalizzazione Substantial variation Effet dénuancé très accentué Akzentuierte Variation

PER UNA POSA OTTIMALE DEL PRODOTTO CONSIGLIAMO SEMPRE DI MESCOLARE ALMENO TRE SCATOLE DI MATERIALE.

For the best product laying results, material from at least three boxes should be mixed.

Pour une pose excellente, nous recommandons toujours de mélanger le contenu d'au moins trois boîtes.

Für eine optimale Verlegung des Erzeugnisses empfehlen wir stets, mindestens drei Packungen Material anzumischen.



Tipologia
Type
Typologie
Typ
Gres porcellanato smaltato
Glazed porcelain
Grès cérame emaille
Feinsteinzeug glasiert

Formati
Sizes
Formats
Formate
30x60
30x30
10x30
5x20

Spessore
Thickness
Épaisseur
Stärke
10 mm

Resistenza scivolosità
Sliding resistance
Resistance au glissement
Rutschfestigkeit
R9

Grado di variazione cromatica
Degree of colour change
Degré de variation chromatique
Grad der Farbabweichung
V2



490498
MET ANTRACITE NAT. 30x60
Cod. **69** □

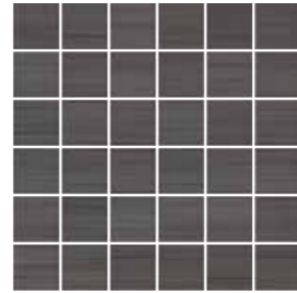

041014
MET ANTRACITE MOSAICO 5x5 SU RETE 30x30
Cod. **24** ○



490499
MET BROWN NAT. 30x60
Cod. **69** □

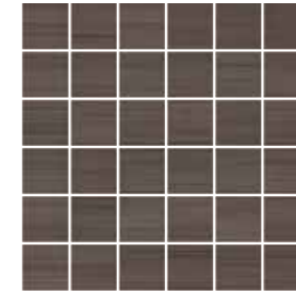

041010
MET BROWN MOSAICO 5x5 SU RETE 30x30
Cod. **24** ○



041008
MET ANTRACITE RETTIFICATO 30x30
Cod. **74** □



390477
MET ANTRACITE MOSAICO FLOOR SU RETE 25x30
Cod. **116** ○



041004
MET BROWN RETTIFICATO 30x30
Cod. **74** □

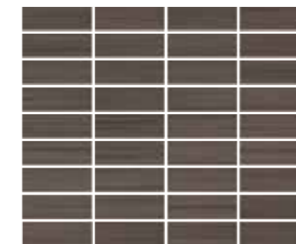

390473
MET BROWN MOSAICO FLOOR SU RETE 25x30
Cod. **116** ○



103084
MET ANTRACITE RETTIFICATO 10x30
Cod. **95** □



380237
MET LISTELLO GREY / ANTRACITE 5x30
Cod. **123** ○



103080
MET BROWN RETTIFICATO 10x30
Cod. **95** □



380236
MET LISTELLO BROWN / SMOKE 5x30
Cod. **123** ○



050213
MET ANTRACITE 5x20
Cod. **93** □



050209
MET BROWN 5x20
Cod. **93** □

IMBALLI • PACKAGES • EMBALLAGES • FORMATE

	SCATOLA • BOX • BOITE • KARTON			PALLET • PALLETS • PALETTS • PALETTE		
	pz	m ^q	kg	box	m ^q	kg
30x60	6	1,08	24,00	40	43,20	960,00
30x30	11	0,99	22,40	46	45,54	1.050,00
10x30	20	0,60	15,00	60	36,00	920,00
5x20	56	0,56	12,30	60	33,60	760,00

IMBALLI • PACKAGES • EMBALLAGES • FORMATE

	SCATOLA • BOX • BOITE • KARTON			PALLET • PALLETS • PALETTS • PALETTE		
	pz	m ^q	kg	box	m ^q	kg
30x60	6	1,08	24,00	40	43,20	960,00
30x30	11	0,99	22,40	46	45,54	1.050,00
10x30	20	0,60	15,00	60	36,00	920,00
5x20	56	0,56	12,30	60	33,60	760,00



490496
MET GREY NAT. 30x60
Cod. **69** □

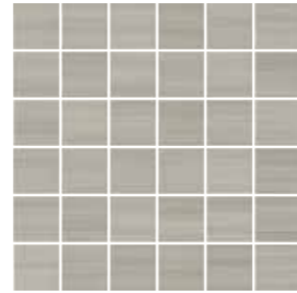

041011
MET GREY MOSAICO 5x5SU RETE 30x30
Cod. **24** ○



490497
MET SMOKE NAT. 30x60
Cod. **69** □

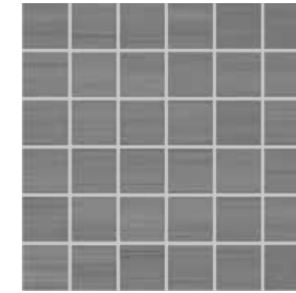

041013
MET SMOKE MOSAICO 5x5 SU RETE 30x30
Cod. **24** ○



041005
MET GREY RETTIFICATO 30x30
Cod. **74** □

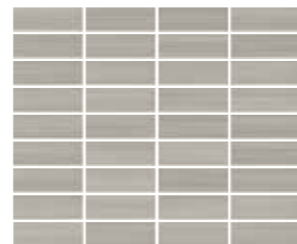

390474
MET GREY MOSAICO FLOOR SU RETE 25x30
Cod. **116** ○



041007
MET SMOKE RETTIFICATO 30x30
Cod. **74** □

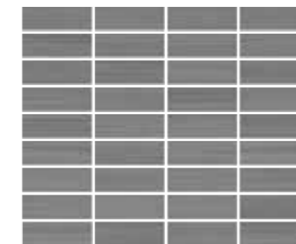

390476
MET SMOKE MOSAICO FLOOR SU RETE 25x30
Cod. **116** ○



103081
MET GREY RETTIFICATO 10x30
Cod. **95** □



380237
MET LISTELLO GREY / ANTRACITE 5x30
Cod. **123** ○



103083
MET SMOKE RETTIFICATO 10x30
Cod. **95** □



380236
MET LISTELLO BROWN / SMOKE 5x30
Cod. **123** ○



050210
MET GREY 5x20
Cod. **93** □



050212
MET SMOKE 5x20
Cod. **93** □

IMBALLI • PACKAGES • EMBALLAGES • FORMATE

	SCATOLA • BOX • BOITE • KARTON			PALLET • PALLETS • PALETTS • PALETTE		
	pz	m ^q	kg	box	m ^q	kg
30x60	6	1,08	24,00	40	43,20	960,00
30x30	11	0,99	25,00	40	39,60	1.020,00
10x30	20	0,60	15,00	60	36,00	920,00
5x20	56	0,56	12,30	60	33,60	760,00

IMBALLI • PACKAGES • EMBALLAGES • FORMATE

	SCATOLA • BOX • BOITE • KARTON			PALLET • PALLETS • PALETTS • PALETTE		
	pz	m ^q	kg	box	m ^q	kg
30x60	6	1,08	24,00	40	43,20	960,00
30x30	11	0,99	25,00	40	39,60	1.020,00
10x30	20	0,60	15,00	60	36,00	920,00
5x20	56	0,56	12,30	60	33,60	760,00



490495
MET WHITE NAT. 30x60
Cod. **69** □



041006
MET WHITE RETTIFICATO 30x30
Cod. **74** □

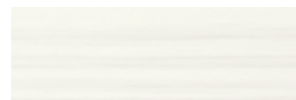

103082
MET WHITE RETTIFICATO 10x30
Cod. **95** □



050211
MET WHITE 5x20
Cod. **93** □



041012
MET WHITE MOSAICO 5x5 SU RETE 30x30
Cod. **24** ○

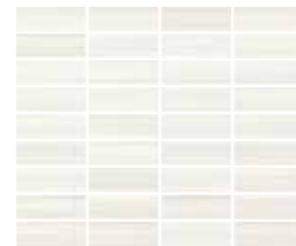

390475
MET WHITE MOSAICO FLOOR SU RETE 25x30
Cod. **116** ○



380237
MET LISTELLO GREY / ANTRACITE 5x30
Cod. **123** ○



12,00 kg



13,75 kg



6,50 kg

IMBALLI • PACKAGES • EMBALLAGES • FORMATE

	SCATOLA • BOX • BOITE • KARTON			PALLET • PALLETS • PALETTS • PALETTE		
	pz	m ^q	kg	box	m ^q	kg
30x60	6	1,08	24,00	40	43,20	960,00
30x30	11	0,99	22,40	46	45,54	1.050,00
10x30	20	0,60	15,00	60	36,00	920,00
5x20	56	0,56	12,30	60	33,60	760,00

Pezzi speciali • Special trims • Pièces spéciales • Formstücke

Battiscopa



9,00 kg



9,00 kg

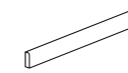

290638
MET ANTRACITE BATTISCOPA 5x30
Cod. **116** △

290634
MET BROWN BATTISCOPA 5x30
Cod. **116** △

290635
MET GREY BATTISCOPA 5x30
Cod. **116** △

290637
MET SMOKE BATTISCOPA 5x30
Cod. **116** △

290636
MET WHITE BATTISCOPA 5x30
Cod. **116** △

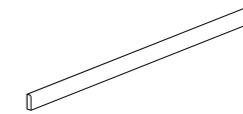

290643
MET ANTRACITE BATTISCOPA 5x60
Cod. **121** △

290639
MET BROWN BATTISCOPA 5x60
Cod. **121** △

290640
MET GREY BATTISCOPA 5x60
Cod. **121** △

290642
MET SMOKE BATTISCOPA 5x60
Cod. **121** △

290641
MET WHITE BATTISCOPA 5x60
Cod. **121** △

CARATTERISTICHE DI QUALITÀ
Quality characteristics
Caractéristiques de qualité
Qualitätseigenschaften

NORMA
Norm
Norme
Norme

REQUISITO NORMA
Required standards
Valeur prescrite selon la norme
Normvorgabe

RISULTATO
Result
Résultat
Ergebnis

	Assorbimento d'acqua Water absorption of the body Absorption d'eau de support Wasseraufnahme des Scherbens	ISO 10545-3	≤ 0,5	Conforme Conformity Conforme Gemäss
	Resistenza a flessione Breaking strenght Résistance à la flexion Biegefestigkeit	ISO 10545-4	≥ 35 N/mm ²	Conforme Conformity Conforme Gemäss
	Resistenza all'abrasione Abrasion resistance Résistance à l'abrasion Abriebbeständigkeit	EN ISO 10545-7	White - Grey Smoke - Brown - Antracite	PEI IV PEI III
	Resistenza al gelo Frost resistance Résistance au gel Frostbeständigkeit	ISO 10545-12	Nessun campione deve presentare rotture o alterazioni apprezzabili alla superficie No samples must show ruptures or noticeable surface alteration Aucuns enchantions doit présenter ruptures ou altérations appréciables de la surface Keines der Muster sollte Risse oder sichtbare Fehler der Oberfläche zeigen	Conforme Conformity Conforme Gemäss
	Resistenza all'attacco chimico Chemical resistance Résistance à l'attaque chimique Beständigkeit gegen chemikalien	ISO 10545-13		GA GLA
	Resistenza agli sbalzi termici Thermal shock resistance Résistance aux écarts de température Temperaturwechselbeständigkeit	ISO 10545-5		Conforme Conformity Conforme Gemäss
	Resistenza scivolosità Sliding resistance Résistance au glissement Rutschfestigkeit	DIN 51130 R		R9
	Coefficiente d'attrito dinamico Wet dynamic coefficient of friction Coefficient de friction dynamique Reibungskoeffizient Schlüpfrigkeit (in Bewegung)	Bot 3000 E	DCOF ≥ 0,42	> 0,42
	Lieve variazione Slight variation Légère variation Geringe Abweichung			V2

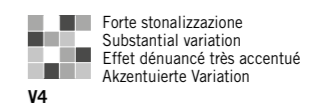
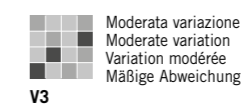
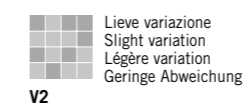
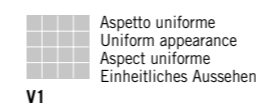

PER UNA POSA OTTIMALE DEL PRODOTTO CONSIGLIAMO SEMPRE DI MESCOLARE ALMENO TRE SCATOLE DI MATERIALE.

For the best product laying results, material from at least three boxes should be mixed.

Pour une pose excellente, nous recommandons toujours de mélanger le contenu d'au moins trois boîtes.

Für eine optimale Verlegung des Erzeugnisses empfehlen wir stets, mindestens drei Packungen Material anzumischen.



Tipologia
Type
Typologie
Typ
Gres porcellanato smaltato
Glazed porcelain
Grès cérame emaille
Feinsteinzeug glasiert

Formati R10 A- B- C
Sizes
Formats
Formate
40x80
20x80
30,4x60,8
60x60
30x60
15x60
30x30
10x30
15x15
7,5x15

Formati R11
Sizes
Formats
Formate
40x80 (20mm)

Spessore
Thickness
Épaisseur
Stärke
10 mm
20 mm

Resistenza scivolosità
Sliding resistance
Resistance au glissement
Rutschfestigkeit
R10 / A+B+C

Grado di variazione cromatica
Degree of colour change
Degré de variation chromatique
Grad der Farbabweichung
V3



606105
MOVE BLACK RETTIFICATO 60x60
Cod. **79** □



490321
MOVE BLACK RETTIFICATO 30x60
Cod. **76** □

490316
MOVE BLACK NATURALE 30,4x60,8
Cod. **69** □



550090
MOVE BLACK RETTIFICATO 15x60
Cod. **95** □

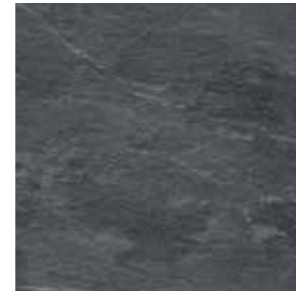

040789
MOVE BLACK RETTIFICATO 30x30
Cod. **78** □



103037
MOVE BLACK RETTIFICATO 10x30
Cod. **95** □



040799
MOVE BLACK SFUSO 7,5x15
Cod. **95** □



230222
MOVE BLACK RETTIFICATO 15x15
Cod. **78** □



310183
MOVE BLACK LONDON 4x30
Cod. **33** ○



2,80 kg



408042
MOVE BLACK RETTIFICATO 40x80
Cod. **79** □



208033
MOVE BLACK RETTIFICATO 20x80
Cod. **89** □

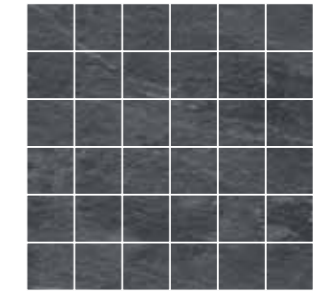

040794
MOVE BLACK MOSAICO 5x5 SU RETE 30x30
Cod. **24** ○



12,30 kg

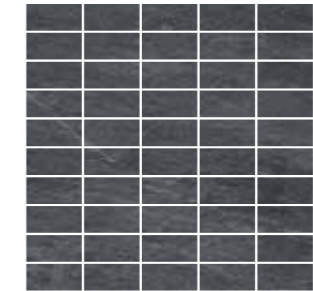

501118
MOVE BLACK FRAME 2,8x5,8 SU RETE 30x30
Cod. **28** ○



12,00 kg



380153
MOVE BLACK BORDURA 5x30
Cod. **21** ○



6,70 kg

SOLO RIVESTIMENTO
Wall application only
Pose mur seulement
Ausschliesslich Wandbordure



123004
MOVE BLACK MOSAICO ONDA 12x30
Cod. **28** ○



6,73 kg

IMBALLI • PACKAGES • EMBALLAGES • FORMATE

	SCATOLA • BOX • BOITE • KARTON			PALLET • PALLETS • PALETTS • PALETTE		
	pz	m ^q	kg	box	m ^q	kg
40x80	3	0,96	23,12	56	53,76	1.315,00
20x80	6	0,96	22,50	42	40,32	935,00
60x60	3	1,08	27,00	40	43,20	1.100,00
30,4x60,8	6	1,11	27,75	40	44,40	1.130,00
30x60	6	1,08	27,00	40	43,20	1.100,00
30x30	11	0,99	23,00	46	45,54	1.058,00
10x30	20	0,60	15,00	60	36,00	920,00
7,5x15	50	0,56	11,30	60	33,60	678,00
15x15	46	1,035	20,20	33	34,15	666,60
15x60	10	0,90	19,60	48	43,20	940,80



606104
MOVE BEIGE RETTIFICATO 60x60
Cod. **79** □



490320
MOVE BEIGE RETTIFICATO 30x60
Cod. **76** □

490315
MOVE BEIGE NATURALE 30,4x60,8
Cod. **69** □



550089
MOVE BEIGE RETTIFICATO 15x60
Cod. **95** □



040787
MOVE BEIGE RETTIFICATO 30x30
Cod. **78** □



103035
MOVE BEIGE RETTIFICATO 10x30
Cod. **95** □



040797
MOVE BEIGE SFUSO 7,5x15
Cod. **95** □



230220
MOVE BEIGE RETTIFICATO 15x15
Cod. **78** □



310181
MOVE BEIGE LONDON 4x30
Cod. **33** ○



408040
MOVE BEIGE RETTIFICATO 40x80
Cod. **79** □



208031
MOVE BEIGE RETTIFICATO 20x80
Cod. **89** □



040792
MOVE BEIGE MOSAICO 5x5 SU RETE 30x30
Cod. **24** ○

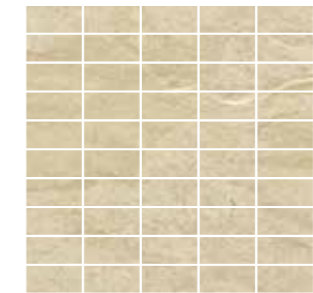

501116
MOVE BEIGE FRAME 2,8x5,8 SU RETE 30x30
Cod. **28** ○



380151
MOVE BEIGE BORDURA 5x30
Cod. **21** ○



SOLO RIVESTIMENTO
Wall application only
Pose mur seulement
Ausschliesslich Wandbordüre

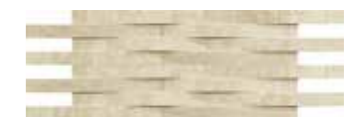

123002
MOVE BEIGE MOSAICO ONDA 12x30
Cod. **28** ○



IMBALLI • PACKAGES • EMBALLAGES • FORMATE

	SCATOLA • BOX • BOITE • KARTON			PALLET • PALLETS • PALETTS • PALETTE		
	pz	mq	kg	box	mq	kg
40x80	3	0,96	23,12	56	53,76	1.315,00
20x80	6	0,96	22,50	42	40,32	935,00
60x60	3	1,08	27,00	40	43,20	1.100,00
30,4x60,8	6	1,11	27,75	40	44,40	1.130,00
30x60	6	1,08	27,00	40	43,20	1.100,00
30x30	11	0,99	23,00	46	45,54	1.058,00
10x30	20	0,60	15,00	60	36,00	920,00
7,5x15	50	0,56	11,30	60	33,60	678,00
15x15	46	1,035	20,20	33	34,15	666,60
15x60	10	0,90	19,60	48	43,20	940,80



606106
MOVE GREY RETTIFICATO 60x60
Cod. **79** □



490322
MOVE GREY RETTIFICATO 30x60
Cod. **76** □

490317
MOVE GREY NATURALE 30,4x60,8
Cod. **69** □



550091
MOVE GREY RETTIFICATO 15x60
Cod. **95** □



040788
MOVE GREY RETTIFICATO 30x30
Cod. **78** □



103036
MOVE GREY RETTIFICATO 10x30
Cod. **95** □



040798
MOVE GREY SFUSO 7,5x15
Cod. **95** □



230221
MOVE GREY RETTIFICATO 15x15
Cod. **78** □



310182
MOVE GREY LONDON 4x30
Cod. **33** ○



408041
MOVE GREY RETTIFICATO 40x80
Cod. **79** □



208032
MOVE GREY RETTIFICATO 20x80
Cod. **89** □

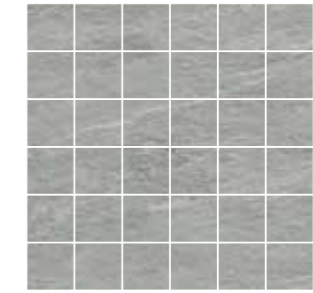

040793
MOVE GREY MOSAICO 5x5 SU RETE 30x30
Cod. **24** ○

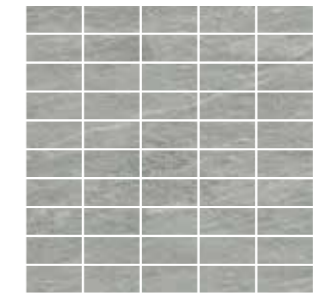

501117
MOVE GREY FRAME 2,8x5,8 SU RETE 30x30
Cod. **28** ○



380152
MOVE GREY BORDURA 5x30
Cod. **21** ○



SOLO RIVESTIMENTO
Wall application only
Pose mur seulement
Ausschliesslich Wandbordüre



123003
MOVE GREY MOSAICO ONDA 12x30
Cod. **28** ○



IMBALLI • PACKAGES • EMBALLAGES • FORMATE

	SCATOLA • BOX • BOITE • KARTON			PALLET • PALLETS • PALETTS • PALETTE		
	pz	m ^q	kg	box	m ^q	kg
40x80	3	0,96	23,12	56	53,76	1.315,00
20x80	6	0,96	22,50	42	40,32	935,00
60x60	3	1,08	27,00	40	43,20	1.100,00
30,4x60,8	6	1,11	27,75	40	44,40	1.130,00
30x60	6	1,08	27,00	40	43,20	1.100,00
30x30	11	0,99	23,00	46	45,54	1.058,00
10x30	20	0,60	15,00	60	36,00	920,00
7,5x15	50	0,56	11,30	60	33,60	678,00
15x15	46	1,035	20,20	33	34,15	666,60
15x60	10	0,90	19,60	48	43,20	940,80



606107
MOVE IVORY RETTIFICATO 60x60
Cod. **79** □



490323
MOVE IVORY RETTIFICATO 30x60
Cod. **76** □

490318
MOVE IVORY NATURALE 30,4x60,8
Cod. **69** □



550092
MOVE IVORY RETTIFICATO 15x60
Cod. **95** □



040786
MOVE IVORY RETTIFICATO 30x30
Cod. **78** □



103034
MOVE IVORY RETTIFICATO 10x30
Cod. **95** □



040796
MOVE IVORY SFUSO 7,5x15
Cod. **95** □



230219
MOVE IVORY RETTIFICATO 15x15
Cod. **78** □



310180
MOVE IVORY LONDON 4x30
Cod. **33** ○



2,80 kg



408039
MOVE IVORY RETTIFICATO 40x80
Cod. **79** □



208030
MOVE IVORY RETTIFICATO 20x80
Cod. **89** □



040791
MOVE IVORY MOSAICO 5x5 SU RETE 30x30
Cod. **24** ○



12,30 kg

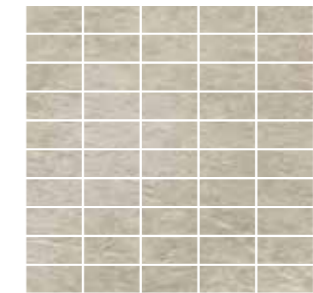

501115
MOVE IVORY FRAME 2,8x5,8 SU RETE 30x30
Cod. **28** ○



12,00 kg



380150
MOVE IVORY BORDURA 5x30
Cod. **21** ○



6,70 kg

SOLO RIVESTIMENTO
Wall application only
Pose mur seulement
Ausschliesslich Wandbordüre



123001
MOVE IVORY MOSAICO ONDA 12x30
Cod. **28** ○



6,73 kg

IMBALLI • PACKAGES • EMBALLAGES • FORMATE

	SCATOLA • BOX • BOITE • KARTON			PALLET • PALLETS • PALETTS • PALETTE		
	pz	m ^q	kg	box	m ^q	kg
40x80	3	0,96	23,12	56	53,76	1.315,00
20x80	6	0,96	22,50	42	40,32	935,00
60x60	3	1,08	27,00	40	43,20	1.100,00
30,4x60,8	6	1,11	27,75	40	44,40	1.130,00
30x60	6	1,08	27,00	40	43,20	1.100,00
30x30	11	0,99	23,00	46	45,54	1.058,00
10x30	20	0,60	15,00	60	36,00	920,00
7,5x15	50	0,56	11,30	60	33,60	678,00
15x15	46	1,035	20,20	33	34,15	666,60
15x60	10	0,90	19,60	48	43,20	940,80



606108
MOVE MUD RETTIFICATO 60x60
Cod. **79** □



490324
MOVE MUD RETTIFICATO 30x60
Cod. **76** □

490319
MOVE MUD NATURALE 30,4x60,8
Cod. **69** □



550093
MOVE MUD RETTIFICATO 15x60
Cod. **95** □



040790
MOVE MUD RETTIFICATO 30x30
Cod. **78** □



103038
MOVE MUD RETTIFICATO 10x30
Cod. **95** □

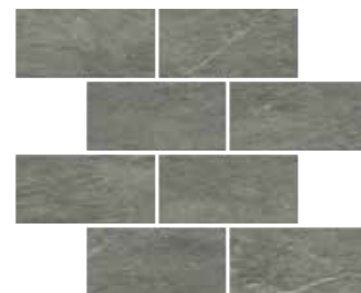

040800
MOVE MUD SFUSO 7,5x15
Cod. **95** □



230223
MOVE MUD RETTIFICATO 15x15
Cod. **78** □



310184
MOVE MUD LONDON 4x30
Cod. **33** ○



408043
MOVE MUD RETTIFICATO 40x80
Cod. **79** □



208034
MOVE MUD RETTIFICATO 20x80
Cod. **89** □

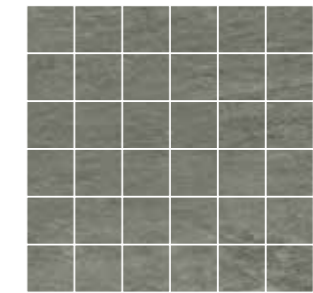

040795
MOVE MUD MOSAICO 5x5 SU RETE 30x30
Cod. **24** ○

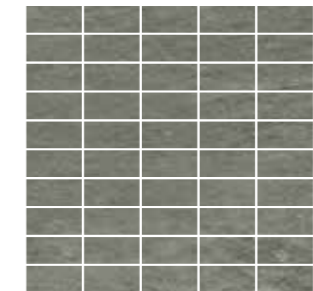

501119
MOVE MUD FRAME 2,8x5,8 SU RETE 30x30
Cod. **28** ○



380154
MOVE MUD BORDURA 5x30
Cod. **21** ○



SOLO RIVESTIMENTO
Wall application only
Pose mur seulement
Ausschliesslich Wandbordüre



123005
MOVE MUD MOSAICO ONDA 12x30
Cod. **28** ○



IMBALLI • PACKAGES • EMBALLAGES • FORMATE

	SCATOLA • BOX • BOITE • KARTON			PALLET • PALLETS • PALETTS • PALETTE		
	pz	m ^q	kg	box	m ^q	kg
40x80	3	0,96	23,12	56	53,76	1.315,00
20x80	6	0,96	22,50	42	40,32	935,00
60x60	3	1,08	27,00	40	43,20	1.100,00
30,4x60,8	6	1,11	27,75	40	44,40	1.130,00
30x60	6	1,08	27,00	40	43,20	1.100,00
30x30	11	0,99	23,00	46	45,54	1.058,00
10x30	20	0,60	15,00	60	36,00	920,00
7,5x15	50	0,56	11,30	60	33,60	678,00
15x15	46	1,035	20,20	33	34,15	666,60
15x60	10	0,90	19,60	48	43,20	940,80



408106
MOVE BLACK 2 CM RETTIFICATO 40x80
Cod. 105 □ 20 mm



408097
MOVE IVORY 2 CM RETTIFICATO 40x80
Cod. 105 □ 20 mm



408098
MOVE BEIGE 2 CM RETTIFICATO 40x80
Cod. 105 □ 20 mm



408099
MOVE MUD 2 CM RETTIFICATO 40x80
Cod. 105 □ 20 mm



408100
MOVE GREY 2 CM RETTIFICATO 40x80
Cod. 105 □ 20 mm

IMBALLI • PACKAGES • EMBALLAGES • FORMATE





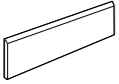

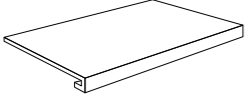
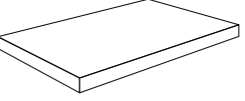

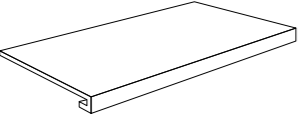
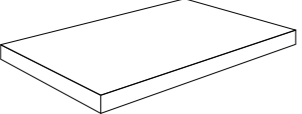

	SCATOLA • BOX • BOITE • KARTON			PALLET • PALLETS • PALETTS • PALETTE		
	pz	mq	kg	box	mq	kg
40x80 (20mm)	2	0,64	31	24	15,36	765,00

Pezzi speciali • Special trims • Pièces spéciales • Formstücke

Battiscopa	44 23,60 kg	18 18,00 kg
	290527 MOVE IVORY BATTISCOPA 7x30 Cod. 116 △	290532 MOVE IVORY BATTISCOPA 7x60 Cod. 121 △
	290528 MOVE BEIGE BATTISCOPA 7x30 Cod. 116 △	290533 MOVE BEIGE BATTISCOPA 7x60 Cod. 121 △
	290529 MOVE GREY BATTISCOPA 7x30 Cod. 116 △	290534 MOVE GREY BATTISCOPA 7x60 Cod. 121 △
	290530 MOVE BLACK BATTISCOPA 7x30 Cod. 116 △	290535 MOVE BLACK BATTISCOPA 7x60 Cod. 121 △
	290531 MOVE MUD BATTISCOPA 7x30 Cod. 116 △	290536 MOVE MUD BATTISCOPA 7x60 Cod. 121 △

Gradino	2 9,50 kg	Angolare	2 9,80 kg
	490349 MOVE IVORY RETTIFICATO GRADINO 33x60 Cod. 112 ○		490354 MOVE IVORY RETTIFICATO ANGOLARE 33x60 Cod. 107 ○
	490346 MOVE BEIGE RETTIFICATO GRADINO 33x60 Cod. 112 ○		490351 MOVE BEIGE RETTIFICATO ANGOLARE 33x60 Cod. 107 ○
	490348 MOVE GREY RETTIFICATO GRADINO 33x60 Cod. 112 ○		490353 MOVE GREY RETTIFICATO ANGOLARE 33x60 Cod. 107 ○
	490347 MOVE BLACK RETTIFICATO GRADINO 33x60 Cod. 112 ○		490352 MOVE BLACK RETTIFICATO ANGOLARE 33x60 Cod. 107 ○
	490350 MOVE MUD RETTIFICATO GRADINO 33x60 Cod. 112 ○		490355 MOVE MUD RETTIFICATO ANGOLARE 33x60 Cod. 107 ○

Gradino	2 15,30 kg	Angolare	2 16,00 kg
	408044 MOVE IVORY RETTIFICATO GRADINO 40x80 Cod. 109 ○		408049 MOVE IVORY RETTIFICATO ANGOLARE 40x80 Cod. 114 ○
	408045 MOVE BEIGE RETTIFICATO GRADINO 40x80 Cod. 109 ○		408050 MOVE BEIGE RETTIFICATO ANGOLARE 40x80 Cod. 114 ○
	408046 MOVE GREY RETTIFICATO GRADINO 40x80 Cod. 109 ○		408051 MOVE GREY RETTIFICATO ANGOLARE 40x80 Cod. 114 ○
	408047 MOVE BLACK RETTIFICATO GRADINO 40x80 Cod. 109 ○		408052 MOVE BLACK RETTIFICATO ANGOLARE 40x80 Cod. 114 ○
	408048 MOVE MUD RETTIFICATO GRADINO 40x80 Cod. 109 ○		408053 MOVE MUD RETTIFICATO ANGOLARE 40x80 Cod. 114 ○

CARATTERISTICHE DI QUALITÀ Quality characteristics Caractéristiques de qualité Qualitätseigenschaften	NORMA Norm Norme Norme	REQUISITO NORMA Required standards Valeur prescrite selon la norme Normvorgabe	RISULTATO Result Résultat Ergebnis
 Assorbimento d'acqua Water absorption of the body Absorption d'eau de support Wasseraufnahme des Scherbens	ISO 10545-3	≤ 0,5	Conforme Conformity Conforme Gemäss
 Resistenza a flessione Breaking strenght Résistance à la flexion Biegefestigkeit	ISO 10545-4	≥ 35 N/mm ²	Conforme Conformity Conforme Gemäss
 Resistenza all'abrasione Abrasion resistance Resistance à l'abrasion Abriebbeständigkeit	EN ISO 10545-7	IVORY - BEIGE - GREY MUD - BLACK	PEI V PEI IV
 Resistenza al gelo Frost resistance Résistance au gel Frostbeständigkeit	ISO 10545-12	Nessun campione deve presentare rotture o alterazioni apprezzabili alla superficie No samples must show ruptures or noticeable surface alteration Aucuns enchantions doit présenter ruptures ou altérations appréciables de la surface Keines der Muster sollte Risse oder sichtbare Fehler der Oberflaeche zeigen	Conforme Conformity Conforme Gemäss
 Resistenza all'attacco chimico Chemical resistance Résistance à l'attaque chimique Beständigkeit gegen chemikalien	ISO 10545-13		GA GLA
 Resistenza agli sbalzi termici Thermal shock resistance Resistance aux ecarts de température Temperaturwechselbeständigkeit	ISO 10545-5		Conforme Conformity Conforme Gemäss
 Resistenza scivolosità Sliding resistance Resistance au glissement Rutschfestigkeit	DIN 51130 R	Move Rettificato e Naturale Move Rettificato (20mm) 40x80	R10 R11
 Resistenza scivolosità Sliding resistance Resistance au glissement Rutschfestigkeit	DIN 51097 (A+B+C)		A+B+C
 Coefficiente d'attrito dinamico Wet dynamic coefficient of friction Coefficient de friction dynamique Reibungskoeffizient Schlüpfigkeit (in Bewegung)	Bot 3000 E	DCOF ≥ 0,42	> 0,42
 Moderata variazione Moderate variation Variation modérée Mäßige Abweichung			V3

 V1	Aspetto uniforme Uniform appearance Aspect uniforme Einheitliches Aussehen	 V2	Lieve variazione Slight variation Légère variation Geringe Abweichung	 V3	Moderata variazione Moderate variation Variation modérée Mäßige Abweichung	 V4	Forte stonizzazione Substantial variation Effet dénuancé très accentué Akzentuierte Variation
--	---	--	--	--	---	--	--

PER UNA POSA OTTIMALE DEL PRODOTTO CONSIGLIAMO SEMPRE DI MESCOLARE ALMENO TRE SCATOLE DI MATERIALE.

For the best product laying results, material from at least three boxes should be mixed.

Pour une pose excellente, nous recommandons toujours de mélanger le contenu d'au moins trois boîtes.

Für eine optimale Verlegung des Erzeugnisses empfehlen wir stets, mindestens drei Packungen Material anzumischen.



Tipologia
Type
Typologie
Typ
Gres porcellanato smaltato
Glazed porcelain
Grès cérame emaille
Feinsteinzeug glasiert

Formati R10
Sizes
Formats
Formate
60x120
60x60
30x60
30x30
10x30

Spessore
Thickness
Épaisseur
Stärke
10 mm

Resistenza scivolosità
Sliding resistance
Resistance au glissement
Rutschfestigkeit
R9

Grado di variazione cromatica
Degree of colour change
Degré de variation chromatique
Grad der Farbabweichung
V3



601278
NEW ARABESCATO NATURALE
RETTIFICATO 60x120
Cod. **94** □

601279
ICONIC BLUE LAPPATO
RETTIFICATO 60x120
Cod. **103** □



606223
NEW ARABESCATO NATURALE
RETTIFICATO 60x60
Cod. **79** □

606224
NEW ARABESCATO LAPPATO
RETTIFICATO 60x60
Cod. **93** □



490687
NEW ARABESCATO NATURALE
RETTIFICATO 30x60
Cod. **76** □

490688
NEW ARABESCATO LAPPATO
RETTIFICATO 30x60
Cod. **85** □

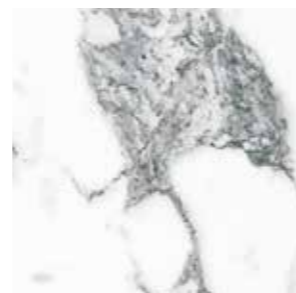

041208
NEW ARABESCATO NATURALE RETTIFICATO
30x30 Cod. **78** □

041209
NEW ARABESCATO LAPPATO RETTIFICATO
30x30 Cod. **90** □



103119
NEW ARABESCATO NATURALE
RETTIFICATO 10x30
Cod. **77** □

103120
NEW ARABESCATO LAPPATO
RETTIFICATO 10x30
Cod. **93** □

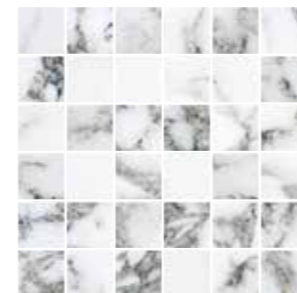

11,40 kg

041240
NEW ARABESCATO NATURALE
MOSAICO 5x5 SU RETE 30x30
Cod. **24** ○

041241
NEW ARABESCATO LAPPATO
MOSAICO 5x5 SU RETE 30x30
Cod. **31** ○



10,30 kg

041242
NEW ARABESCATO NATURALE
ESAGONO 27x28
Cod. **136** ○

041243
NEW ARABESCATO LAPPATO
ESAGONO 27x28
Cod. **49** ○



13,20 kg

041228
NEW ARABESCATO NATURALE
MOSAICO HB 28x32
Cod. **45** ○

041229
NEW ARABESCATO LAPPATO
MOSAICO HB 28x32
Cod. **48** ○



10,30 kg

041222
NEW ARABESCATO NATURALE
ESAGONO INTARSIO 20,7x27
Cod. **57** ○

041223
NEW ARABESCATO LAPPATO
ESAGONO INTARSIO 20,7x27
Cod. **72** ○



4,5 kg

380299
NEW ARABESCATO NATURALE
BORDURA MURETTO 7x30
Cod. **28** ○

380300
NEW ARABESCATO LAPPATO
BORDURA MURETTO LAPPATO 7x30
Cod. **28** ○



6,44 kg

380293
NEW ARABESCATO NATURALE
LONDON 5x30
Cod. **33** ○

380294
NEW ARABESCATO LUCIDO
LONDON 5x30
Cod. **33** ○

IMBALLI • PACKAGES • EMBALLAGES • FORMATE

	SCATOLA • BOX • BOITE • KARTON			PALLET • PALLETS • PALETTS • PALETTE		
	pz	mq	kg	box	mq	kg
60x120	2	1,44	33,00	30	43,20	1.010,00
60x60	3	1,08	24,10	40	43,20	980,00
30x60	6	1,08	24,48	40	43,20	980,00
30x30	11	0,99	23,20	46	45,54	1.070,00
10x30	20	0,60	15,00	60	36,00	920,00

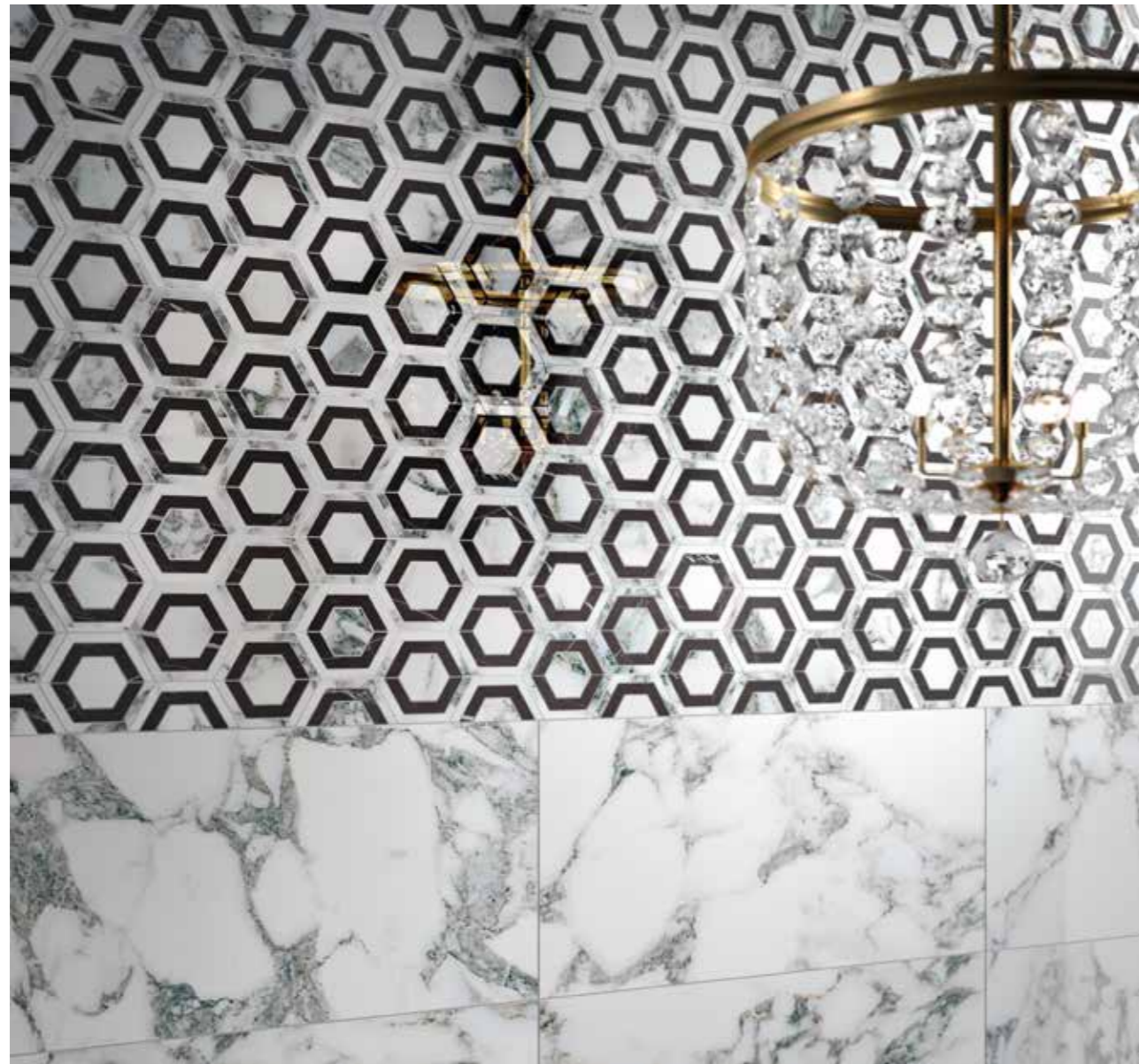

new arabescato RETT. LAPPATO

La finitura lappata è consigliata per uso rivestimento o per pavimenti da bagno in ambito residenziale. Nello specifico il tipo di pavimentazione deve essere non soggetta ad eccessive sollecitazioni e mai a diretto contatto con aree esterne. Come si verifica comunemente nelle pietre naturali l'eventuale presenza di puntini sulla superficie o di qualche disuniformità della lucentezza sono da considerare caratteristiche del prodotto derivanti dalla lavorazione a cui viene sottoposto.

The polished finish is recommended for wall coverings or for the floors of residential bathrooms. Specifically, floor coverings in this material must not be subjected to excessively heavy traffic and must never be in direct contact with outdoor areas. As is often the case with natural stones, any spots on the surface or any unevenness in shine are typical characteristics of the product, deriving from the process used.

La finitura polie est recommandée pour le revêtement sol et mur des salles de bains résidentielles. Notamment, ce type de carreau au sol ne doit pas être exposé à des contraintes excessives, et il ne doit jamais être en contact direct avec des zones extérieures. Comme cela est souvent le cas pour les pierres naturelles, les micro trous éventuellement présents à la surface du produit ou l'hétérogénéité de son éclat forment des caractéristiques propres au façonnage.

Die polierte Oberfläche wird für Wandverkleidungen und Bodenbeläge in Privatbädern empfohlen. Der Bodenbelag darf keinen starken Beanspruchungen ausgesetzt sein und keinen direkten Kontakt zu Außenbereichen haben. Wie bei Natursteinen üblich, kann die Oberfläche Körnungen oder einen unregelmäßigen Glanz aufweisen. Diese Merkmale sind typische, beabsichtigte Produkteigenschaften, die durch das Bearbeitungsverfahren hervorgerufen werden.

Pezzi speciali • Special trims • Pièces spéciales • Formstücke

Battiscopa

44
23,60 kg

18
18,00 kg

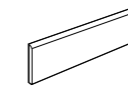

290762
NEW ARABESCATO NATURALE
BATTISCOPA 7x30
Cod. **116** △

290763
NEW ARABESCATO LAPPATO
BATTISCOPA 7x30
Cod. **22** △

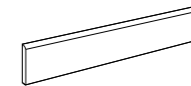

290768
NEW ARABESCATO NATURALE
BATTISCOPA 7x60
Cod. **121** △

290769
NEW ARABESCATO LAPPATO
BATTISCOPA 7x60
Cod. **26** △

CARATTERISTICHE DI QUALITÀ Quality characteristics Caractéristiques de qualité Qualitätseigenschaften	NORMA Norm Norme Norme	REQUISITO NORMA Required standards Valeur prescrite selon la norme Normvorgabe	RISULTATO Result Résultat Ergebniss
Assorbimento d'acqua Water absorption of the body Absorption d'eau de support Wasseraufnahme des Scherbens	ISO 10545-3	≤ 0,5	Conforme Conformity Conforme Gemäss
Resistenza a flessione Breaking strenght Résistance à la flexion Biegefestigkeit	ISO 10545-4	≥ 35 N/mm ²	Conforme Conformity Conforme Gemäss
Resistenza all'abrasione Abrasion resistance Résistance à l'abrasion Abriebbeständigkeit	ISO 10545-7	New Arabescato Rettificato	PEI IV
Resistenza al gelo Frost resistance Résistance au gel Frostbeständigkeit	ISO 10545-12	Nessun campione deve presentare rotture o alterazioni apprezzabili alla superficie No samples must show ruptures or noticeable surface alteration Aucuns enchantions doit présenter ruptures ou altérations appréciables de la surface Keines der Muster sollte Risse oder sichtbare Fehler der Oberflaeche zeigen	Conforme Conformity Conforme Gemäss
Resistenza all'attacco chimico Chemical resistance Résistance à l'attaque chimique Beständigkeit gegen chemikalien	ISO 10545-13	New Arabescato Naturale New Arabescato Lappato	GA GLA GA GLB
Resistenza agli sbalzi termici Thermal shock resistance Résistance aux écarts de température Temperaturwechselbeständigkeit	ISO 10545-5		Conforme Conformity Conforme Gemäss
Resistenza scivolosità Sliding resistance Résistance au glissement Rutschfestigkeit	DIN 51130 R		R9
Moderata variazione Moderate variation Variation modérée Mäßige Abweichung		New Arabescato Rettificato	V3

Aspetto uniforme
Uniform appearance
Aspect uniforme
Einheitliches Aussehen
V1

Lieve variazione
Slight variation
Légère variation
Geringe Abweichung
V2

Moderata variazione
Moderate variation
Variation modérée
Mäßige Abweichung
V3

Forte stonalizzazione
Substantial variation
Effet dénuancé très accentué
Akzentuierte Variation
V4

PER UNA POSA OTTIMALE DEL PRODOTTO CONSIGLIAMO SEMPRE DI MESCOLARE ALMENO TRE SCATOLE DI MATERIALE.

For the best product laying results, material from at least three boxes should be mixed.

Pour une pose excellente, nous recommandons toujours de mélanger le contenu d'au moins trois boîtes.

Für eine optimale Verlegung des Erzeugnisses empfehlen wir stets, mindestens drei Packungen Material anzumischen.



Tipologia
Type
Typologie
Typ
Gres porcellanato smaltato
Glazed porcelain
Grès cérame emailé
Feinsteinzeug glasiert

Formati R10
Sizes
Formats
Formate
40,8x61,4
40,8x40,8
20,3x40,8
20,3x20,3
10,3x20,3
MIX BOX

Formati R11 A - B - C
Sizes
Formats
Formate
40,8x61,4
MIX BOX

Spessore
Thickness
Épaisseur
Stärke
9,8 mm

Resistenza scivolosità
Sliding resistance
Resistance au glissement
Rutschfestigkeit
R10 / A+B
R11 / A+B+C

Grado di variazione cromatica
Degree of colour change
Degré de variation chromatique
Grad der Farbabweichung
V3



406009
OPUS STONE AVORIO
NATURALE 40,8x61,4
Cod. **70** □

406024
OPUS STONE AVORIO
NATURALE **R11** 40,8x61,4
Cod. **75** □



204006
OPUS STONE AVORIO
NATURALE 20,3x40,8
Cod. **78** □



130071
OPUS STONE AVORIO NATURALE 20,3x20,3
Cod. **96** □



103108
OPUS STONE AVORIO
NATURALE 10,3x20,3
Cod. **88** □



406018
OPUS STONE GRIGIO
NATURALE 40,8x61,4
Cod. **70** □

406033
OPUS STONE GRIGIO
NATURALE **R11** 40,8x61,4
Cod. **75** □



204009
OPUS STONE GRIGIO
NATURALE 20,3x40,8
Cod. **78** □



130074
OPUS STONE GRIGIO NATURALE 20,3x20,3
Cod. **96** □



103111
OPUS STONE GRIGIO
NATURALE 10,3x20,3
Cod. **88** □



404009
OPUS STONE AVORIO
NATURALE 40,8x40,8
Cod. **71** □

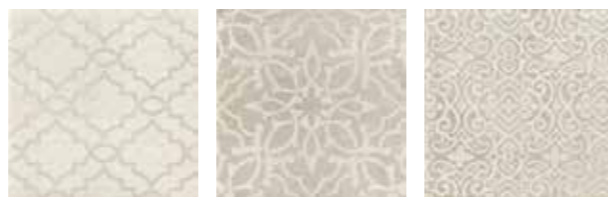
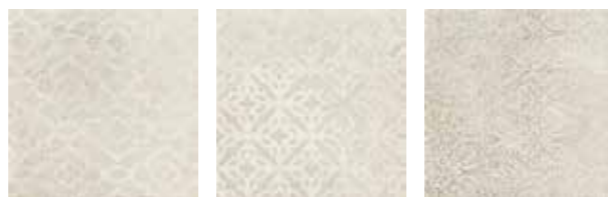
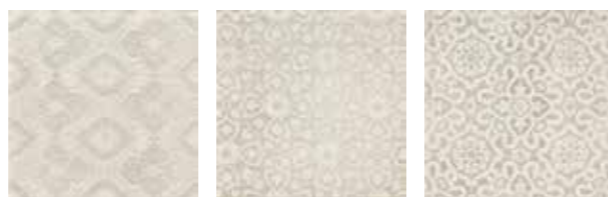

130077
OPUS STONE DECORO GRIGIO / AVORIO
20,3x20,3
Cod. **104** □



404012
OPUS STONE GRIGIO
NATURALE 40,8x40,8
Cod. **71** □



130077
OPUS STONE DECORO GRIGIO / AVORIO
20,3x20,3
Cod. **104** □



10,70 kg

041195
OPUS STONE AVORIO NATURALE
MOSAICO 5x5 SU RETE 30x30
Cod. **26** ○



10,70 kg

041198
OPUS STONE GRIGIO NATURALE
MOSAICO 5x5 SU RETE 30x30
Cod. **26** ○

IMBALLI • PACKAGES • EMBALLAGES • FORMATE

	SCATOLA • BOX • BOITE • KARTON			PALLET • PALLETS • PALETTS • PALETTE		
	pz	m ^q	kg	box	m ^q	kg
MIX BOX	6	0,75	14,30	44,00	33,00	650,00
40,8x61,4	5	1,253	24,00	48,00	60,14	1.170,00
40,8x40,8	6	0,999	19,10	36,00	35,96	700,00
20,3x40,8	12	0,989	19,10	54,00	53,68	1.050,00
20,3x20,3	24	0,994	19,00	54,00	53,41	1.050,00
10,3x20,3	32	0,640	12,40	60,00	38,40	770,00

IMBALLI • PACKAGES • EMBALLAGES • FORMATE

	SCATOLA • BOX • BOITE • KARTON			PALLET • PALLETS • PALETTS • PALETTE		
	pz	m ^q	kg	box	m ^q	kg
MIX BOX	6	0,75	14,30	44,00	33,00	650,00
40,8x61,4	5	1,253	24,00	48,00	60,14	1.170,00
40,8x40,8	6	0,999	19,10	36,00	35,96	700,00
20,3x40,8	12	0,989	19,10	54,00	53,68	1.050,00
20,3x20,3	24	0,994	19,00	54,00	53,41	1.050,00
10,3x20,3	32	0,640	12,40	60,00	38,40	770,00



406012
OPUS STONE BEIGE
NATURALE 40,8x61,4
Cod. **70** □

406027
OPUS STONE BEIGE
NATURALE **R11** 40,8x61,4
Cod. **75** □



204007
OPUS STONE BEIGE
NATURALE 20,3x40,8
Cod. **78** □



130072
OPUS STONE BEIGE NATURALE 20,3x20,3
Cod. **96** □



103109
OPUS STONE BEIGE
NATURALE 10,3x20,3
Cod. **88** □



406021
OPUS STONE TORTORA
NATURALE 40,8x61,4
Cod. **70** □

406036
OPUS STONE TORTORA
NATURALE **R11** 40,8x61,4
Cod. **75** □



204010
OPUS STONE TORTORA
NATURALE 20,3x40,8
Cod. **78** □



130075
OPUS STONE TORTORA NATURALE 20,3x20,3
Cod. **96** □

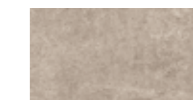

103112
OPUS STONE TORTORA
NATURALE 10,3x20,3
Cod. **88** □



404010
OPUS STONE BEIGE
NATURALE 40,8x40,8
Cod. **71** □

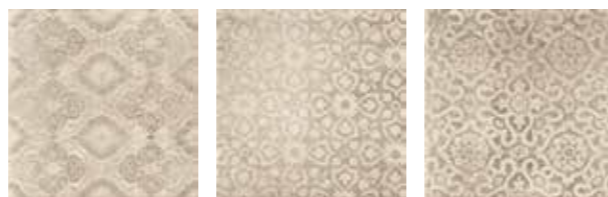
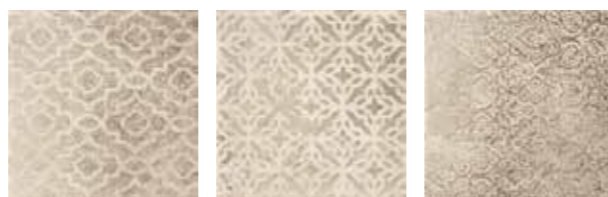

130078
OPUS STONE DECORO BEIGE / TORTORA
20,3x20,3
Cod. **104** □

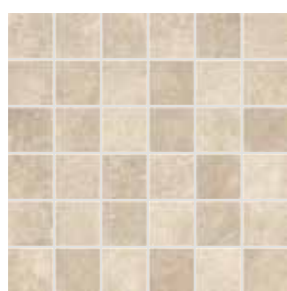

10,70 kg

041196
OPUS STONE BEIGE NATURALE
MOSAICO 5x5 SU RETE 30x30
Cod. **26** ○



404013
OPUS STONE TORTORA
NATURALE 40,8x40,8
Cod. **71** □



130078
OPUS STONE DECORO BEIGE / TORTORA
20,3x20,3
Cod. **104** □



10,70 kg

041199
OPUS STONE TORTORA NATURALE
MOSAICO 5x5 SU RETE 30x30
Cod. **26** ○

IMBALLI • PACKAGES • EMBALLAGES • FORMATE

	SCATOLA • BOX • BOITE • KARTON			PALLET • PALLETS • PALETTS • PALETTE		
	pz	m ^q	kg	box	m ^q	kg
MIX BOX	6	0,75	14,30	44,00	33,00	650,00
40,8x61,4	5	1,253	24,00	48,00	60,14	1.170,00
40,8x40,8	6	0,999	19,10	36,00	35,96	700,00
20,3x40,8	12	0,989	19,10	54,00	53,68	1.050,00
20,3x20,3	24	0,994	19,00	54,00	53,41	1.050,00
10,3x20,3	32	0,640	12,40	60,00	38,40	770,00

IMBALLI • PACKAGES • EMBALLAGES • FORMATE

	SCATOLA • BOX • BOITE • KARTON			PALLET • PALLETS • PALETTS • PALETTE		
	pz	m ^q	kg	box	m ^q	kg
MIX BOX	6	0,75	14,30	44,00	33,00	650,00
40,8x61,4	5	1,253	24,00	48,00	60,14	1.170,00
40,8x40,8	6	0,999	19,10	36,00	35,96	700,00
20,3x40,8	12	0,989	19,10	54,00	53,68	1.050,00
20,3x20,3	24	0,994	19,00	54,00	53,41	1.050,00
10,3x20,3	32	0,640	12,40	60,00	38,40	770,00



406015
OPUS STONE BLU
NATURALE 40,8x61,4
Cod. **70** □

406030
OPUS STONE BLU
NATURALE **R11** 40,8x61,4
Cod. **75** □



204008
OPUS STONE BLU
NATURALE 20,3x40,8
Cod. **78** □



130073
OPUS STONE BLU NATURALE 20,3x20,3
Cod. **96** □



103110
OPUS STONE BLU
NATURALE 10,3x20,3
Cod. **88** □



404011
OPUS STONE BLU
NATURALE 40,8x40,8
Cod. **71** □



130076
OPUS STONE DECORO BLU 20,3x20,3
Cod. **104** □



041197
OPUS STONE BLU NATURALE
MOSAICO 5x5 SU RETE 30x30
Cod. **26** ○



10,70 kg

IMBALLI • PACKAGES • EMBALLAGES • FORMATE

	SCATOLA • BOX • BOITE • KARTON			PALLET • PALLETS • PALETTS • PALETTE		
	pz	mq	kg	box	mq	kg
MIX BOX	6	0,75	14,30	44,00	33,00	650,00
40,8x61,4	5	1,253	24,00	48,00	60,14	1.170,00
40,8x40,8	6	0,999	19,10	36,00	35,96	700,00
20,3x40,8	12	0,989	19,10	54,00	53,68	1.050,00
20,3x20,3	24	0,994	19,00	54,00	53,41	1.050,00
10,3x20,3	32	0,640	12,40	60,00	38,40	770,00



Suggerimenti di posa • Laying proposals • Solutions de pose • Verlegevorschläge

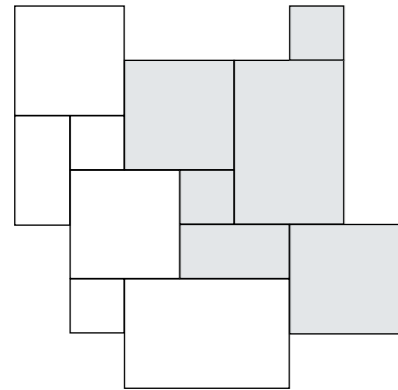

- | | |
|--|--|
| 406040
OPUS STONE AVORIO NATURALE
MIX BOX
Cod. 120 □ | 406048
OPUS STONE AVORIO NATURALE
MIX BOX R11
Cod. 79 □ |
| 406043
OPUS STONE GRIGIO NATURALE
MIX BOX
Cod. 120 □ | 406051
OPUS STONE GRIGIO NATURALE
MIX BOX R11
Cod. 79 □ |
| 406041
OPUS STONE BEIGE NATURALE
MIX BOX
Cod. 120 □ | 406049
OPUS STONE BEIGE NATURALE
MIX BOX R11
Cod. 79 □ |
| 406039
OPUS STONE TORTORA NATURALE
MIX BOX
Cod. 120 □ | 406047
OPUS STONE TORTORA NATURALE
MIX BOX R11
Cod. 79 □ |
| 406042
OPUS STONE BLU NATURALE
MIX BOX
Cod. 120 □ | 406050
OPUS STONE BLU NATURALE
MIX BOX R11
Cod. 79 □ |

IMBALLI • PACKAGES • EMBALLAGES • FORMATE

	SCATOLA • BOX • BOITE • KARTON			PALLET • PALLETS • PALETTES • PALETTE		
	pz	mq	kg	box	mq	kg
MIX BOX	6	0,75	14,30	44,00	33,00	650,00

Pezzi speciali • Special trims • Pièces spéciales • Formstücke

Battiscopa



15,00 kg

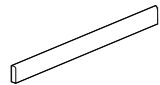

- 290728**
OPUS STONE AVORIO
BATTISCOPA 6,2x40,8
Cod. **121** △
- 290731**
OPUS STONE GRIGIO
BATTISCOPA 6,2x40,8
Cod. **121** △
- 290729**
OPUS STONE BEIGE
BATTISCOPA 6,2x40,8
Cod. **121** △

- 290732**
OPUS STONE TORTORA
BATTISCOPA 6,2x40,8
Cod. **121** △
- 290730**
OPUS STONE BLU
BATTISCOPA 6,2x40,8
Cod. **121** △

Lineare ad "L"



10,00 kg

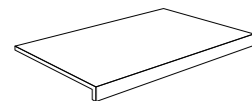

- 490651**
OPUS STONE AVORIO LINEARE
AD "L" 33x61,4x5
Cod. **111** ○
- 490654**
OPUS STONE GRIGIO LINEARE
AD "L" 33x61,4x5
Cod. **111** ○
- 490652**
OPUS STONE BEIGE LINEARE
AD "L" 33x61,4x5
Cod. **111** ○
- 490655**
OPUS STONE TORTORA LINEARE
AD "L" 33x61,4x5
Cod. **111** ○
- 490653**
OPUS STONE BLU LINEARE
AD "L" 33x61,4x5
Cod. **111** ○

Angolare ad "L"



11,00 kg

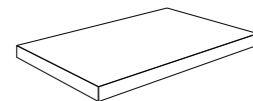

- 490656**
OPUS STONE AVORIO ANGOLARE
AD "L" 33x61,4
Cod. **112** ○
- 490659**
OPUS STONE GRIGIO ANGOLARE
AD "L" 33x61,4
Cod. **112** ○
- 490657**
OPUS STONE BEIGE ANGOLARE
AD "L" 33x61,4
Cod. **112** ○
- 490660**
OPUS STONE TORTORA ANGOLARE
AD "L" 33x61,4
Cod. **112** ○
- 490658**
OPUS STONE BLU ANGOLARE
AD "L" 33x61,4
Cod. **112** ○

Suggerimenti di posa • Laying proposals • Solutions de pose • Verlegevorschläge

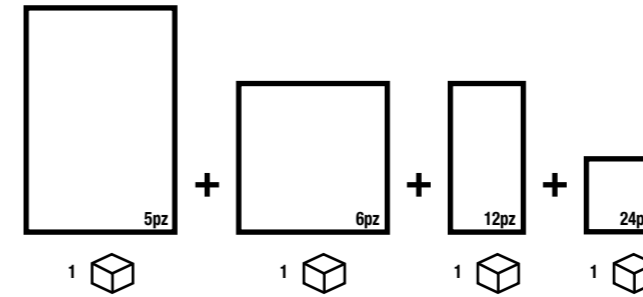

40,8 x 61,4 33,46 % 20,3 x 40,8 11,06 %
40,8 x 40,8 44,47 % 20,3 x 20,3 11,01 %

- | | |
|---|--|
| 600162
OPUS STONE AVORIO NATURALE
COMPO 1
Cod. 117 □ | 600166
OPUS STONE TORTORA NATURALE
COMPO 1
Cod. 117 □ |
| 600165
OPUS STONE GRIGIO NATURALE
COMPO 1
Cod. 117 □ | 600164
OPUS STONE BLU NATURALE
COMPO 1
Cod. 117 □ |
| 600163
OPUS STONE BEIGE NATURALE
COMPO 1
Cod. 117 □ | |

CARATTERISTICHE DI QUALITÀ Quality characteristics Caractéristiques de qualité Qualitätseigenschaften	NORMA Norm Norme Norme	REQUISITO NORMA Required standards Valeur prescrite selon la norme Normvorgabe	RISULTATO Result Résultat Ergebniss
Assorbimento d'acqua Water absorption of the body Absorption d'eau de support Wasseraufnahme des Scherbens	ISO 10545-3	≤ 0,5	Conforme Conformity Conforme Gemäss
Resistenza a flessione Breaking strength Résistance à la flexion Biegefestigkeit	ISO 10545-4	≥ 35 N/mm ²	Conforme Conformity Conforme Gemäss
Resistenza all'abrasione Abrasion resistance Résistance à l'abrasion Abriebbeständigkeit	EN ISO 10545-7		PEI V
Resistenza al gelo Frost resistance Résistance au gel Frostbeständigkeit	ISO 10545-12	Nessun campione deve presentare rotture o alterazioni apprezzabili alla superficie No samples must show ruptures or noticeable surface alteration Aucuns enchantions doit présenter ruptures ou altérations appréciables de la surface Keines der Muster sollte Risse oder sichtbare Fehler der Oberfläche zeigen	Conforme Conformity Conforme Gemäss
Resistenza all'attacco chimico Chemical resistance Résistance à l'attaque chimique Beständigkeit gegen chemikalien	ISO 10545-13		GA GLA
Resistenza agli sbalzi termici Thermal shock resistance Résistance aux écarts de température Temperaturwechselbeständigkeit	ISO 10545-5		Conforme Conformity Conforme Gemäss
Resistenza scivolosità Sliding resistance Résistance au glissement Rutschfestigkeit	DIN 51130 R	Opus Stone Naturale Opus Stone Naturale R11	R10 R11
Resistenza scivolosità Sliding resistance Résistance au glissement Rutschfestigkeit	DIN 51097 (A+B+C)	Opus Stone Naturale Opus Stone Naturale R11	A+B A+B+C
Coefficiente d'attrito dinamico Wet dynamic coefficient of friction Coefficient de friction dynamique Reibungskoeffizient Schlupfrigkeit (in Bewegung)	Bot 3000 E	DCOF ≥ 0,42	> 0,42
Moderata variazione Moderate variation Variation modérée Mäßige Abweichung			V3

- | | | | |
|--|---|--|---|
| V1
Aspetto uniforme
Uniform appearance
Aspect uniforme
Einheitliches Aussehen | V2
Lieve variazione
Slight variation
Légère variation
Geringe Abweichung | V3
Moderata variazione
Moderate variation
Variation modérée
Mäßige Abweichung | V4
Forte stonizzazione
Substantial variation
Effet dénuancé très accentué
Akzentuierte Variation |
|--|---|--|---|

PER UNA POSA OTTIMALE DEL PRODOTTO CONSIGLIAMO SEMPRE DI MESCOLARE ALMENO TRE SCATOLE DI MATERIALE.

For the best product laying results, material from at least three boxes should be mixed.

Pour une pose excellente, nous recommandons toujours de mélanger le contenu d'au moins trois boîtes.

Für eine optimale Verlegung des Erzeugnisses empfehlen wir stets, mindestens drei Packungen Material anzumischen.



Tipologia
Type
Typologie
Typ
Gres porcellanato smaltato
Glazed porcelain
Grès cérame emaille
Feinsteinzeug glasiert

Formati
Sizes
Formats
Formate
120x280
120x120
60x120
60x60
30x120
30x60
10x60
10x30
5x20

Spessore
Thickness
Épaisseur
Stärke
10 mm
6 mm

Resistenza scivolosità
Sliding resistance
Resistance au glissement
Rutschfestigkeit
R10

Grado di variazione cromatica
Degree of colour change
Degré de variation chromatique
Grad der Farbabweichung
V3

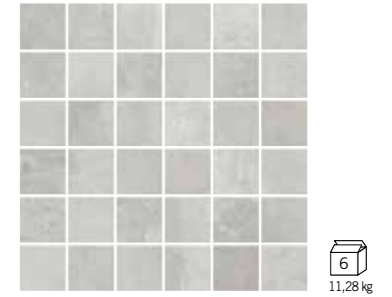

041254
PLATFORM POWDER
MOSAICO 5x5 SU RETE 30x30
Cod. **24** ○



041281
PLATFORM POWDER
MOSAICO LOSANGA 28x21,8
Cod. **71** ○

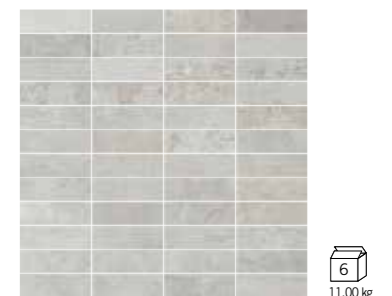

041305
PLATFORM POWDER MOSAICO FRAME
2,5x7,5 SU RETE 30x30
Cod. **24** ○



120282
PLATFORM POWDER RETTIFICATO 120x280
Cod. **112** □

✕ 6 mm



121211
PLATFORM POWDER RETTIFICATO 120x120
Cod. **106** □

6 mm



301254
PLATFORM POWDER RETTIFICATO 30x120
Cod. **99** □



601282
PLATFORM POWDER RETTIFICATO 60x120
Cod. **94** □



606233
PLATFORM POWDER RETTIFICATO 60x60
Cod. **79** □



490693
PLATFORM POWDER RETTIFICATO 30x60
Cod. **76** □



106024
PLATFORM POWDER RETTIFICATO 10x60
Cod. **83** □



103127
PLATFORM POWDER RETTIFICATO 10x30
Cod. **77** □



050233
PLATFORM POWDER RETTIFICATO
5x20 Cod. **93** □

IMBALLI • PACKAGES • EMBALLAGES • FORMATE

	SCATOLA • BOX • BOITE • KARTON			PALLET • PALLETS • PALETTS • PALETTE		
	<i>pz</i>	<i>mq</i>	<i>kg</i>	<i>box</i>	<i>mq</i>	<i>kg</i>
120x120	2	2,88	21,80	24	69,12	1.039,00
60x120	2	1,44	32,50	30	43,20	1.000,00
60x60	3	1,08	23,60	40	43,26	965,00
30x120	3	1,08	24,20	42	45,36	1.040,00
30x60	6	1,08	23,90	40	43,20	980,00
10x60	12	0,72	16,00	60	43,20	985,00
10x30	20	0,60	13,00	60	36,00	800,00
5x20	56	0,56	11,70	60	33,60	730,00

	CASSA • CRATE • CAISSE • HOLZKISTE			CAVALLETTO • A-FRAME • CHEVALET • TRANSPORTGESTELL					
	<i>pz</i>	<i>mq</i>	<i>kg</i>	<i>pz</i>	<i>mq</i>	<i>kg</i>			
120x280	1	3,36	47,04	20	67,20	1.090,00	44	147,84	2.220,00



PLATFORM



120283
PLATFORM SAGE RETTIFICATO 120x280
Cod. 112 □

± 6 mm



6
11,28 kg

041255
PLATFORM SAGE MOSAICO
5x5 SU RETE 30x30
Cod. 24 ○



6
11,00 kg

041282
PLATFORM SAGE MOSAICO
LOSANGA 28x21,8
Cod. 71 ○

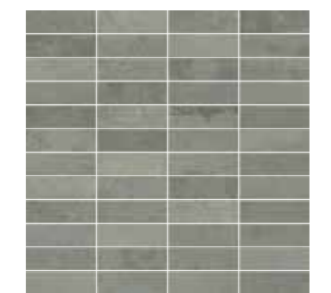

6
11,00 kg

041306
PLATFORM SAGE MOSAICO
FRAME 2,5x7,5 SU RETE 30x30
Cod. 24 ○

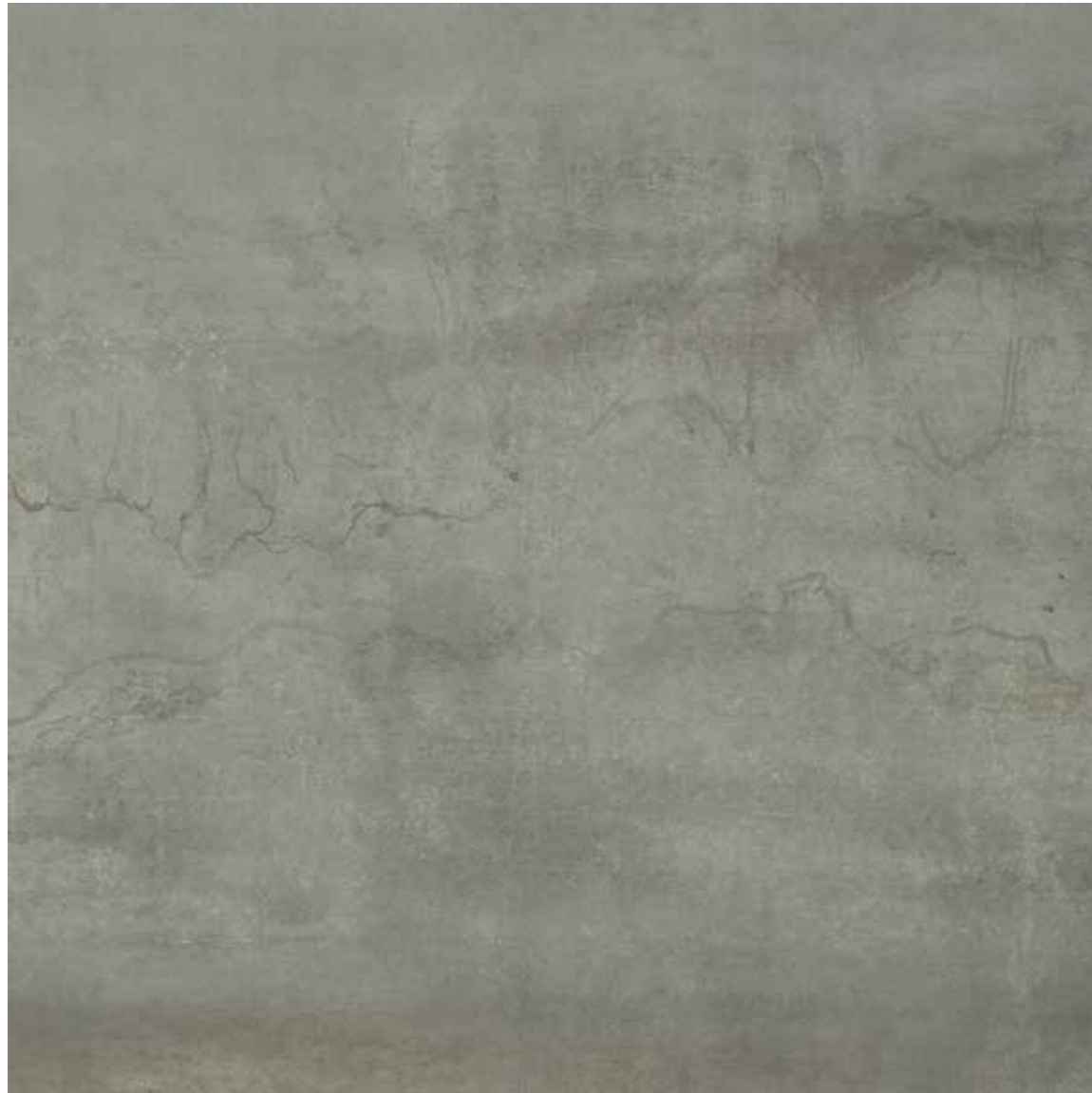

121212
PLATFORM SAGE RETTIFICATO 120x120
Cod. **106** □

6 mm



301255
PLATFORM SAGE RETTIFICATO 30x120
Cod. **99** □



601283
PLATFORM SAGE RETTIFICATO 60x120
Cod. **94** □



606234
PLATFORM SAGE RETTIFICATO 60x60
Cod. **79** □



490694
PLATFORM SAGE RETTIFICATO 30x60
Cod. **76** □



106025
PLATFORM SAGE RETTIFICATO 10x60
Cod. **83** □



103128
PLATFORM SAGE RETTIFICATO 10x30
Cod. **77** □



050234
PLATFORM SAGE RETTIFICATO
5x20 Cod. **93** □

IMBALLI • PACKAGES • EMBALLAGES • FORMATE

	SCATOLA • BOX • BOITE • KARTON			PALLET • PALLETS • PALETTS • PALETTE		
	<i>pz</i>	<i>mq</i>	<i>kg</i>	<i>box</i>	<i>mq</i>	<i>kg</i>
120x120	2	2,88	21,80	24	69,12	1.039,00
60x120	2	1,44	32,50	30	43,20	1.000,00
60x60	3	1,08	23,60	40	43,26	965,00
30x120	3	1,08	24,20	42	45,36	1.040,00
30x60	6	1,08	23,90	40	43,20	980,00
10x60	12	0,72	16,00	60	43,20	985,00
10x30	20	0,60	13,00	60	36,00	800,00
5x20	56	0,56	11,70	60	33,60	730,00

	CASSA • CRATE • CAISSE • HOLZKISTE			CAVALLETTO • A-FRAME • CHEVALET • TRANSPORTGESTELL					
	<i>pz</i>	<i>mq</i>	<i>kg</i>	<i>pz</i>	<i>mq</i>	<i>kg</i>			
120x280	1	3,36	47,04	20	67,20	1.090,00	44	147,84	2.220,00



6
11,28 kg

041252
PLATFORM BLUE
MOSAICO 5x5 SU RETE 30x30
Cod. **24** ○



6
11,00 kg

041279
PLATFORM BLUE
MOSAICO LOSANGA 28x21,8
Cod. **71** ○

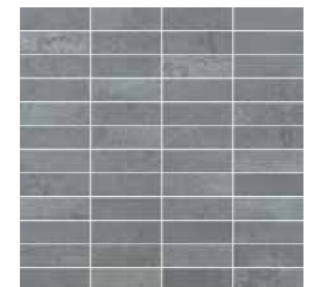

6
11,00 kg

041303
PLATFORM BLUE MOSAICO
FRAME 2,5x7,5 SU RETE 30x30
Cod. **24** ○

120280
PLATFORM BLUE RETTIFICATO 120x280
Cod. **112** □

✕ 6 mm



121209
PLATFORM BLUE RETTIFICATO 120x120
Cod. **106** □

6 mm



301252
PLATFORM BLUE RETTIFICATO 30x120
Cod. **99** □



601280
PLATFORM BLUE RETTIFICATO 60x120
Cod. **94** □

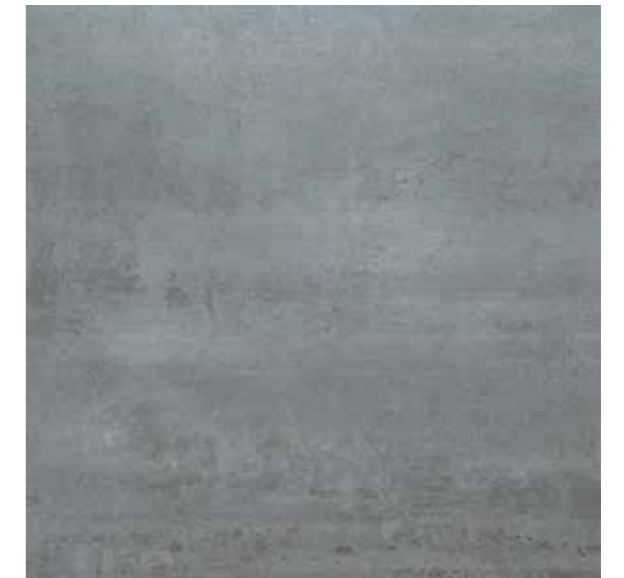

606231
PLATFORM BLUE RETTIFICATO 60x60
Cod. **79** □



490691
PLATFORM BLUE RETTIFICATO 30x60
Cod. **76** □



106022
PLATFORM BLUE RETTIFICATO 10x60
Cod. **83** □



103125
PLATFORM BLUE RETTIFICATO 10x30
Cod. **77** □



050231
PLATFORM BLUE RETTIFICATO
5x20 Cod. **93** □

IMBALLI • PACKAGES • EMBALLAGES • FORMATE

	SCATOLA • BOX • BOITE • KARTON			PALLET • PALLETS • PALETTS • PALETTE		
	<i>pz</i>	<i>mq</i>	<i>kg</i>	<i>box</i>	<i>mq</i>	<i>kg</i>
120x120	2	2,88	21,80	24	69,12	1.039,00
60x120	2	1,44	32,50	30	43,20	1.000,00
60x60	3	1,08	23,60	40	43,26	965,00
30x120	3	1,08	24,20	42	45,36	1.040,00
30x60	6	1,08	23,90	40	43,20	980,00
10x60	12	0,72	16,00	60	43,20	985,00
10x30	20	0,60	13,00	60	36,00	800,00
5x20	56	0,56	11,70	60	33,60	730,00

	CASSA • CRATE • CAISSE • HOLZKISTE			CAVALLETTO • A-FRAME • CHEVALET • TRANSPORTGESTELL					
	<i>pz</i>	<i>mq</i>	<i>kg</i>	<i>pz</i>	<i>mq</i>	<i>kg</i>			
120x280	1	3,36	47,04	20	67,20	1.090,00	44	147,84	2.220,00



120281
PLATFORM BRONZE RETTIFICATO 120x280
Cod. 112 □

± 6 mm

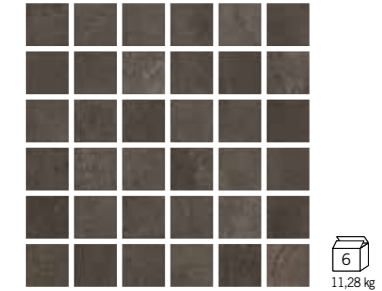

041253
PLATFORM BRONZE
MOSAICO 5x5 SU RETE 30x30
Cod. 24 ○



11,28 kg

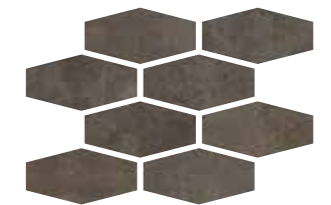

041280
PLATFORM BRONZE
MOSAICO LOSANGA 28x21,8
Cod. 71 ○



11,00 kg

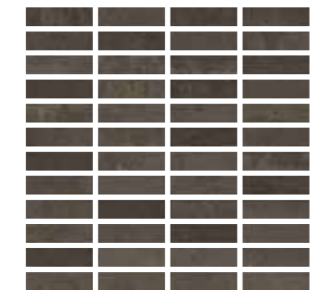

041304
PLATFORM BRONZE MOSAICO
FRAME 2,5x7,5 SU RETE 30x30
Cod. 24 ○



11,00 kg



121210
PLATFORM BRONZE RETTIFICATO 120x120
Cod. **106** □

6 mm



301253
PLATFORM BRONZE RETTIFICATO 30x120
Cod. **99** □



601281
PLATFORM BRONZE RETTIFICATO 60x120
Cod. **94** □



606232
PLATFORM BRONZE RETTIFICATO 60x60
Cod. **79** □



490692
PLATFORM BRONZE RETTIFICATO 30x60
Cod. **76** □



106023
PLATFORM BRONZE RETTIFICATO 10x60
Cod. **83** □



103126
PLATFORM BRONZE RETTIFICATO 10x30
Cod. **77** □



050232
PLATFORM BRONZE RETTIFICATO
5x20 Cod. **93** □

IMBALLI • PACKAGES • EMBALLAGES • FORMATE

	SCATOLA • BOX • BOITE • KARTON			PALLET • PALLETS • PALETTS • PALETTE		
	<i>pz</i>	<i>mq</i>	<i>kg</i>	<i>box</i>	<i>mq</i>	<i>kg</i>
120x120	2	2,88	21,80	24	69,12	1.039,00
60x120	2	1,44	32,50	30	43,20	1.000,00
60x60	3	1,08	23,60	40	43,26	965,00
30x120	3	1,08	24,20	42	45,36	1.040,00
30x60	6	1,08	23,90	40	43,20	980,00
10x60	12	0,72	16,00	60	43,20	985,00
10x30	20	0,60	13,00	60	36,00	800,00
5x20	56	0,56	11,70	60	33,60	730,00

	CASSA • CRATE • CAISSE • HOLZKISTE			CAVALLETTO • A-FRAME • CHEVALET • TRANSPORTGESTELL					
	<i>pz</i>	<i>mq</i>	<i>kg</i>	<i>pz</i>	<i>mq</i>	<i>kg</i>			
120x280	1	3,36	47,04	20	67,20	1.090,00	44	147,84	2.220,00

Pezzi speciali • Special trims • Pièces spéciales • Formstücke

Battiscopa



13,30 kg



290772
PLATFORM POWDER
BATTISCOPIA 5x30
Cod. **116** △

290773
PLATFORM SAGE
BATTISCOPIA 5x30
Cod. **116** △

290770
PLATFORM BLUE
BATTISCOPIA 5x30
Cod. **116** △

290771
PLATFORM BRONZE
BATTISCOPIA 5x30
Cod. **116** △



13,40 kg

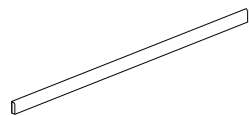

290776
PLATFORM POWDER
BATTISCOPIA 5x60
Cod. **121** △

290777
PLATFORM SAGE
BATTISCOPIA 5x60
Cod. **121** △

290774
PLATFORM BLUE
BATTISCOPIA 5x60
Cod. **121** △

290775
PLATFORM BRONZE
BATTISCOPIA 5x60
Cod. **121** △



12,00 kg

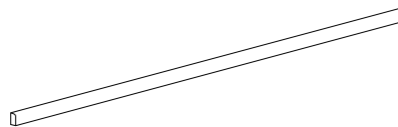

290780
PLATFORM POWDER
BATTISCOPIA 5x120
Cod. **33** △

290781
PLATFORM SAGE
BATTISCOPIA 5x120
Cod. **33** △

290778
PLATFORM BLUE
BATTISCOPIA 5x120
Cod. **33** △

290779
PLATFORM BRONZE
BATTISCOPIA 5x120
Cod. **33** △

Gradino



29,40 kg

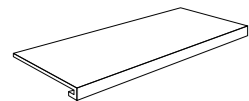

490697
PLATFORM POWDER
GRADINO 33x60
Cod. **112** ○

490698
PLATFORM SAGE
GRADINO 33x60
Cod. **112** ○

490695
PLATFORM BLUE
GRADINO 33x60
Cod. **112** ○

490696
PLATFORM BRONZE
GRADINO 33x60
Cod. **112** ○

Angolare



10,00 kg

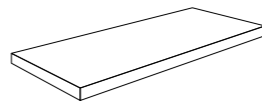

490701
PLATFORM POWDER
ANGOLARE 33x60
Cod. **107** ○

490702
PLATFORM SAGE
ANGOLARE 33x60
Cod. **107** ○

490699
PLATFORM BLUE
ANGOLARE 33x60
Cod. **107** ○

490700
PLATFORM BRONZE
ANGOLARE 33x60
Cod. **107** ○

Gradino



17,30 kg

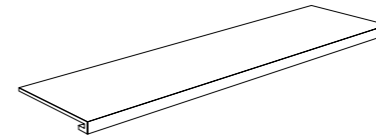

490705
PLATFORM POWDER
GRADINO 33x120
Cod. **114** ○

490706
PLATFORM SAGE
GRADINO 33x120
Cod. **114** ○

490703
PLATFORM BLUE
GRADINO 33x120
Cod. **114** ○

490704
PLATFORM BRONZE
GRADINO 33x120
Cod. **114** ○

Angolare



20,00 kg

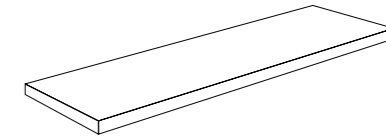

490709
PLATFORM POWDER
ANGOLARE 33x120
Cod. **110** ○

490710
PLATFORM SAGE
ANGOLARE 33x120
Cod. **110** ○

490707
PLATFORM BLUE
ANGOLARE 33x120
Cod. **110** ○

490708
PLATFORM BRONZE
ANGOLARE 33x120
Cod. **110** ○

CARATTERISTICHE DI QUALITÀ Quality characteristics Caractéristiques de qualité Qualitätseigenschaften	NORMA Norm Norme Norme	REQUISITO NORMA Required standards Valeur prescrite selon la norme Normvorgabe	RISULTATO Result Résultat Ergebniss
Assorbimento d'acqua Water absorption of the body Absorption d'eau de support Wasseraufnahme des Scherbens	ISO 10545-3	≤ 0,5	Conforme Conformity Conforme Gemäss
Resistenza a flessione Breaking strenght Résistance à la flexion Biegefestigkeit	ISO 10545-4	≥ 35 N/mm ²	Conforme Conformity Conforme Gemäss
Resistenza all'abrasione Abrasion resistance Résistance à l'abrasion Abriebbeständigkeit	EN ISO 10545-7	Powder	PEI V
		Blue - Bronze - Sage	PEI IV
Resistenza al gelo Frost resistance Résistance au gel Frostbeständigkeit	ISO 10545-12	Nessun campione deve presentare rotture o alterazioni apprezzabili alla superficie No samples must show ruptures or noticeable surface alteration Aucuns enchantions doit présenter ruptures ou altérations appréciables de la surface Keines der Muster sollte Risse oder sichtbare Fehler der Oberfläche zeigen	Conforme Conformity Conforme Gemäss
Resistenza all'attacco chimico Chemical resistance Résistance à l'attaque chimique Beständigkeit gegen chemikalien	ISO 10545-13		GA GLA
Resistenza agli sbalzi termici Thermal shock resistance Résistance aux écarts de température Temperaturwechselbeständigkeit	ISO 10545-5		Conforme Conformity Conforme Gemäss
Resistenza scivolosità Sliding resistance Résistance au glissement Rutschfestigkeit	DIN 51130 R		R10
Coefficiente d'attrito dinamico Wet dynamic coefficient of friction Coefficient de friction dynamique Reibungskoeffizient Schlüpfrigkeit (in Bewegung)	Bot 3000 E	DCOF ≥ 0,42	> 0,42
Moderata variazione Moderate variation Variation modérée Mäßige Abweichung			V3

Aspetto uniforme
Uniform appearance
Aspect uniforme
Einheitliches Aussehen
V1

Lieve variazione
Slight variation
Légère variation
Geringe Abweichung
V2

Moderata variazione
Moderate variation
Variation modérée
Mäßige Abweichung
V3

Forte stonizzazione
Substantial variation
Effet dénuancé très accentué
Akzentuierte Variation
V4

PER UNA POSA OTTIMALE DEL PRODOTTO CONSIGLIAMO SEMPRE DI MESCOLARE ALMENO TRE SCATOLE DI MATERIALE.

For the best product laying results, material from at least three boxes should be mixed.

Pour une pose excellente, nous recommandons toujours de mélanger le contenu d'au moins trois boîtes.

Für eine optimale Verlegung des Erzeugnisses empfehlen wir stets, mindestens drei Packungen Material anzumischen.



Tipologia
Type
Typologie
Typ
Gres porcellanato smaltato
Glazed porcelain
Grès cérame emaille
Feinsteinzeug glasiert

Formati
Sizes
Formats
Formate
60x120
60x60
30x60
30x30
10x30

Spessore
Thickness
Épaisseur
Stärke
10 mm

Resistenza scivolosità
Sliding resistance
Resistance au glissement
Rutschfestigkeit
R9

Grado di variazione cromatica
Degree of colour change
Degré de variation chromatique
Grad der Farbabweichung
V3



601266
PREMIUM ONYX NATURALE
RETTIFICATO 60x120
Cod. **94** □

601267
PREMIUM ONYX LAPPATO
RETTIFICATO 60x120
Cod. **103** □



606202
PREMIUM ONYX NATURALE
RETTIFICATO 60x60
Cod. **79** □

606204
PREMIUM ONYX LAPPATO
RETTIFICATO 60x60
Cod. **93** □



490560
PREMIUM ONYX NATURALE
RETTIFICATO 30x60
Cod. **76** □

490562
PREMIUM ONYX LAPPATO
RETTIFICATO 30x60
Cod. **85** □



040919
PREMIUM ONYX NATURALE RETTIFICATO 30x30
Cod. **78** □

040923
PREMIUM ONYX LAPPATO RETTIFICATO 30x30
Cod. **90** □



103103
PREMIUM ONYX NATURALE
RETTIFICATO 10x30
Cod. **77** □

103106
PREMIUM ONYX LAPPATO
RETTIFICATO 10x30
Cod. **111** □

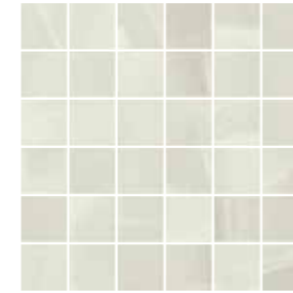

040920
PREMIUM ONYX NATURALE
MOSAICO 5x5 SU RETE 30x30
Cod. **24** ○  11,40 kg

040924
PREMIUM ONYX LAPPATO
MOSAICO 5x5 SU RETE 30x30
Cod. **31** ○



041137
PREMIUM ONYX NATURALE
MOSAICO INTARSIO 30x30
Cod. **31** ○  10,30 kg

041138
PREMIUM ONYX LAPPATO
MOSAICO INTARSIO 30x30
Cod. **35** ○



041125
PREMIUM ONYX NATURALE
MOSAICO HB 28x32
Cod. **45** ○  13,20 kg

041136
PREMIUM ONYX LAPPATO
MOSAICO HB 28x32
Cod. **48** ○

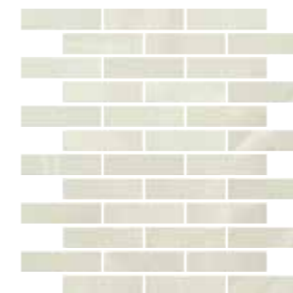

041128
PREMIUM ONYX NATURALE
MURETTO 2.4x10
SU RETE 30x30
Cod. **46** ○  10,30 kg

041139
PREMIUM ONYX LAPPATO
MURETTO 2.4x10
SU RETE 30x30
Cod. **58** ○



040921
PREMIUM ONYX NATURALE
MOSAICO ESAGONO 27x28
Cod. **136** ○  10,30 kg

041135
PREMIUM ONYX LAPPATO
MOSAICO ESAGONO 27x28
Cod. **49** ○



041173
PREMIUM ONYX NATURALE
MOSAICO ARABESQUE
SU RETE 30x30
Cod. **57** ○  12,00 kg

041174
PREMIUM ONYX LAPPATO
MOSAICO ARABESQUE
SU RETE 30x30
Cod. **72** ○

IMBALLI • PACKAGES • EMBALLAGES • FORMATE

	SCATOLA • BOX • BOITE • KARTON			PALLET • PALLETS • PALETTS • PALETTE		
	pz	mq	kg	box	mq	kg
60x120	2	1,44	33,00	30	43,20	1.015,00
60x60	3	1,08	24,00	40	43,20	990,00
30x60	6	1,08	24,00	40	43,20	990,00
30x30	11	0,99	23,00	46	45,54	1.085,00
10x30	20	0,60	15,00	60	36,00	920,00



380268
PREMIUM ONYX NATURALE
LONDON 5x30
Cod. **33** ○  3,22 kg

380269
PREMIUM ONYX LUCIDO
LONDON 5x30
Cod. **33** ○



premium onyx RETT. LAPPATO

La finitura lappata è consigliata per uso rivestimento o per pavimenti da bagno in ambito residenziale. Nello specifico il tipo di pavimentazione deve essere non soggetta ad eccessive sollecitazioni e mai a diretto contatto con aree esterne. Come si verifica comunemente nelle pietre naturali l'eventuale presenza di puntini sulla superficie o di qualche disuniformità della lucentezza sono da considerare caratteristiche del prodotto derivanti dalla lavorazione a cui viene sottoposto.

The polished finish is recommended for wall coverings or for the floors of residential bathrooms. Specifically, floor coverings in this material must not be subjected to excessively heavy traffic and must never be in direct contact with outdoor areas. As is often the case with natural stones, any spots on the surface or any unevenness in shine are typical characteristics of the product, deriving from the process used.

La finitura polie est recommandée pour le revêtement sol et mur des salles de bains résidentielles. Notamment, ce type de carreau au sol ne doit pas être exposé à des contraintes excessives, et il ne doit jamais être en contact direct avec des zones extérieures. Comme cela est souvent le cas pour les pierres naturelles, les micro trous éventuellement présents à la surface du produit ou l'hétérogénéité de son éclat forment des caractéristiques propres au façonnage.

Die polierte Oberfläche wird für Wandverkleidungen und Bodenbeläge in Privatbädern empfohlen. Der Bodenbelag darf keinen starken Beanspruchungen ausgesetzt sein und keinen direkten Kontakt zu Außenbereichen haben. Wie bei Natursteinen üblich, kann die Oberfläche Körnungen oder einen unregelmäßigen Glanz aufweisen. Diese Merkmale sind typische, beabsichtigte Produkteigenschaften, die durch das Bearbeitungsverfahren hervorgerufen werden.

Pezzi speciali • Special trims • Pièces spéciales • Formstücke

Battiscopa



23,60 kg

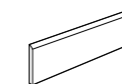

290711
PREMIUM ONYX NATURALE
BATTISCOPIA 7x30
Cod. **116** △

290712
PREMIUM ONYX LAPPATO
BATTISCOPIA 7x30
Cod. **22** △

CARATTERISTICHE DI QUALITÀ Quality characteristics Caractéristiques de qualité Qualitätseigenschaften	NORMA Norm Norme Norme	REQUISITO NORMA Required standards Valeur prescrite selon la norme Normvorgabe	RISULTATO Result Résultat Ergebnis
Assorbimento d'acqua Water absorption of the body Absorption d'eau de support Wasseraufnahme des Scherbens	ISO 10545-3	≤ 0,5	Conforme Conformity Conforme Gemäss
Resistenza a flessione Breaking strenght Résistance à la flexion Biegefestigkeit	ISO 10545-4	≥ 35 N/mm ²	Conforme Conformity Conforme Gemäss
Resistenza all'abrasione Abrasion resistance Resistance à l'abrasion Abriebbeständigkeit	ISO 10545-7	Premium Onyx Rettificato Premium Onyx Lappato	PEI IV
Resistenza al gelo Frost resistance Résistance au gel Frostbeständigkeit	ISO 10545-12	Nessun campione deve presentare rotture o alterazioni apprezzabili alla superficie No samples must show ruptures or noticeable surface alteration Aucuns enchantions doit présenter ruptures ou altérations appréciables de la surface Keines der Muster sollte Risse oder sichtbare Fehler der Oberfläche zeigen	Conforme Conformity Conforme Gemäss
Resistenza all'attacco chimico Chemical resistance Résistance à l'attaque chimique Beständigkeit gegen chemikalien	ISO 10545-13	Premium Onyx Rettificato Premium Onyx Lappato	GA GLA GA GLB
Resistenza agli sbalzi termici Thermal shock resistance Résistance aux écarts de température Temperaturwechselbeständigkeit	ISO 10545-5		Conforme Conformity Conforme Gemäss
Resistenza scivolosità Sliding resistance Résistance au glissement Rutschfestigkeit	DIN 51130 R	Premium Onyx Rettificato Premium Onyx Lappato	R9
Moderata variazione Moderate variation Variation modérée Mäßige Abweichung			V3

Aspetto uniforme
Uniform appearance
Aspect uniforme
Einheitliches Aussehen
V1

Lieve variazione
Slight variation
Légère variation
Geringe Abweichung
V2

Moderata variazione
Moderate variation
Variation modérée
Mäßige Abweichung
V3

Forte stonizzazione
Substantial variation
Effet dénuancé très accentué
Akzentuierte Variation
V4

PER UNA POSA OTTIMALE DEL PRODOTTO CONSIGLIAMO SEMPRE DI MESCOLARE ALMENO TRE SCATOLE DI MATERIALE.

For the best product laying results, material from at least three boxes should be mixed.

Pour une pose excellente, nous recommandons toujours de mélanger le contenu d'au moins trois boîtes.

Für eine optimale Verlegung des Erzeugnisses empfehlen wir stets, mindestens drei Packungen Material anzumischen.



Tipologia
Type
Typologie
Typ
Gres porcellanato smaltato
Glazed porcelain
Grès cérame émaille
Feinsteinzeug glasiert

Formati R10
Sizes
Formats
Formate
40x80
20x80
40x40
10x40
7,5x15

Formati R11 A - B - C
Sizes
Formats
Formate
40x80
40x40
5x5 su rete 30x30

Spessore
Thickness
Épaisseur
Stärke
10 mm

Resistenza scivolosità
Sliding resistance
Resistance au glissement
Rutschfestigkeit
R10-R11

Grado di variazione cromatica
Degree of colour change
Degré de variation chromatique
Grad der Farbabweichung
V3



408080
QUARRY GOLD RETTIFICATO 40x80
Cod. **79** □

408092
QUARRY GOLD RETTIFICATO 40x80 **R11**
Cod. **83** □



208035
QUARRY GOLD RETTIFICATO 20x80
Cod. **89** □



404001
QUARRY GOLD RETTIFICATO 40x40
Cod. **82** □

404005
QUARRY GOLD RETTIFICATO 40x40 **R11**
Cod. **85** □



104001
QUARRY GOLD RETTIFICATO 10x40
Cod. **85** □



408081
QUARRY IVORY RETTIFICATO 40x80
Cod. **79** □

408093
QUARRY IVORY RETTIFICATO 40x80 **R11**
Cod. **83** □



208037
QUARRY IVORY RETTIFICATO 20x80
Cod. **89** □



404002
QUARRY IVORY RETTIFICATO 40x40
Cod. **82** □

404006
QUARRY IVORY RETTIFICATO 40x40 **R11**
Cod. **85** □



104002
QUARRY IVORY RETTIFICATO 10x40
Cod. **85** □



040846
QUARRY GOLD MOSAICO
INTARSIO 5x5 SU RETE 30x30
Cod. **31** ○



10,50 kg



040850
QUARRY GOLD MOSAICO 5x5
SU RETE 30x30
Cod. **24** ○



12,30 kg

040879
QUARRY GOLD MOSAICO 5x5
SU RETE 30x30 **R11**
Cod. **24** ○



040842
QUARRY GOLD SFUSO 7,5x15
Cod. **95** □



040875
QUARRY GOLD MURETTO 2x10
SU RETE 30x30
Cod. **46** ○



18,00 kg



040847
QUARRY IVORY MOSAICO
INTARSIO 5x5 SU RETE 30x30
Cod. **31** ○



10,50 kg



040851
QUARRY IVORY
MOSAICO 5x5 SU RETE 30x30
Cod. **24** ○



12,30 kg

040880
QUARRY IVORY
MOSAICO 5x5 SU RETE 30x30 **R11**
Cod. **24** ○



040843
QUARRY IVORY SFUSO 7,5x15
Cod. **95** □



040876
QUARRY IVORY MURETTO
2x10 SU RETE 30x30
Cod. **46** ○



18,00 kg

IMBALLI • PACKAGES • EMBALLAGES • FORMATE

	SCATOLA • BOX • BOITE • KARTON			PALLET • PALLETS • PALETTS • PALETTE		
	pz	mq	kg	box	mq	kg
40x80	3	0,96	22,50	56	53,76	1295,00
20x80	6	0,96	22,50	42	40,32	945,00
40x40	6	0,96	22,50	36	34,56	810,00
10x40	20	0,80	18,75	60	48,00	1125,00
7,5x15	50	0,56	11,30	60	33,60	678,00

IMBALLI • PACKAGES • EMBALLAGES • FORMATE

	SCATOLA • BOX • BOITE • KARTON			PALLET • PALLETS • PALETTS • PALETTE		
	pz	mq	kg	box	mq	kg
40x80	3	0,96	22,50	56	53,76	1295,00
20x80	6	0,96	22,50	42	40,32	945,00
40x40	6	0,96	22,50	36	34,56	810,00
10x40	20	0,80	18,75	60	48,00	1125,00
7,5x15	50	0,56	11,30	60	33,60	678,00



408082
QUARRY TAUPE RETTIFICATO 40x80
Cod. **79** □

408094
QUARRY TAUPE RETTIFICATO 40x80 **R11**
Cod. **83** □



208038
QUARRY TAUPE RETTIFICATO 20x80
Cod. **89** □



404003
QUARRY TAUPE RETTIFICATO 40x40
Cod. **82** □

404007
QUARRY TAUPE RETTIFICATO 40x40 **R11**
Cod. **85** □



104003
QUARRY TAUPE RETTIFICATO 10x40
Cod. **85** □



040848
QUARRY TAUPE MOSAICO
INTARSIO 5x5 SU RETE 30x30
Cod. **31** ○



10,50 kg



040852
QUARRY TAUPE MOSAICO 5x5
SU RETE 30x30
Cod. **24** ○



12,30 kg

040881
QUARRY TAUPE MOSAICO 5x5
SU RETE 30x30 **R11**
Cod. **24** ○



040844
QUARRY TAUPE SFUSO 7,5x15
Cod. **95** □



040877
QUARRY TAUPE MURETTO 2x10
SU RETE 30x30
Cod. **46** ○



18,00 kg

IMBALLI • PACKAGES • EMBALLAGES • FORMATE

	SCATOLA • BOX • BOITE • KARTON			PALLET • PALLETS • PALETTS • PALETTE		
	pz	mq	kg	box	mq	kg
40x80	3	0,96	22,50	56	53,76	1295,00
20x80	6	0,96	22,50	42	40,32	945,00
40x40	6	0,96	22,50	36	34,56	810,00
10x40	20	0,80	18,75	60	48,00	1125,00
7,5x15	50	0,56	11,30	60	33,60	678,00



408083
QUARRY GREY RETTIFICATO 40x80
Cod. **79** □

408095
QUARRY GREY RETTIFICATO 40x80 **R11**
Cod. **83** □



040849
QUARRY GREY MOSAICO
INTARSIO 5x5 SU RETE 30x30
Cod. **31** ○



10,50 kg

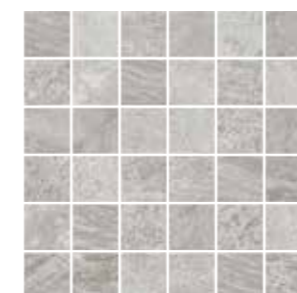

040853
QUARRY GREY
MOSAICO 5x5 SU RETE 30x30
Cod. **24** ○



12,30 kg

040882
QUARRY GREY
MOSAICO 5x5 SU RETE 30x30 **R11**
Cod. **24** ○

IMBALLI • PACKAGES • EMBALLAGES • FORMATE

	SCATOLA • BOX • BOITE • KARTON			PALLET • PALLETS • PALETTS • PALETTE		
	pz	mq	kg	box	mq	kg
40x80	3	0,96	22,50	56	53,76	1295,00
20x80	6	0,96	22,50	42	40,32	945,00
40x40	6	0,96	22,50	36	34,56	810,00
10x40	20	0,80	18,75	60	48,00	1125,00
7,5x15	50	0,56	11,30	60	33,60	678,00



404004
QUARRY GREY RETTIFICATO 40x40
Cod. **82** □

404008
QUARRY GREY RETTIFICATO 40x40 **R11**
Cod. **85** □



104004
QUARRY GREY RETTIFICATO 10x40
Cod. **85** □



040845
QUARRY GREY SFUSO 7,5x15
Cod. **95** □



040878
QUARRY GREY MURETTO
2x10 SU RETE 30x30
Cod. **46** ○







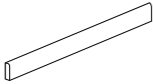
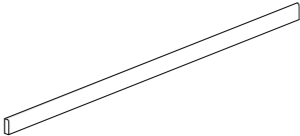

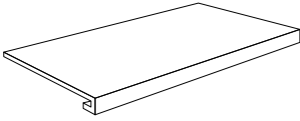
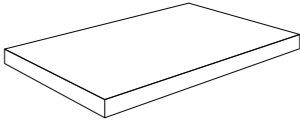



18,00 kg

Pezzi speciali • Special trims • Pièces spéciales • Formstücke

Battiscopa		Angolare	
15,00 kg		15,00 kg	
	290562 QUARRY GOLD BATTISCOPA 6x40 Cod. 121 △		290561 QUARRY GOLD ANGOLARE 40x80 Cod. 33 △
	290563 QUARRY IVORY BATTISCOPA 6x40 Cod. 121 △		290560 QUARRY IVORY ANGOLARE 40x80 Cod. 33 △
	290564 QUARRY TAUPE BATTISCOPA 6x40 Cod. 121 △		290581 QUARRY TAUPE ANGOLARE 40x80 Cod. 33 △
	290565 QUARRY GREY BATTISCOPA 6x40 Cod. 121 △		290580 QUARRY GREY ANGOLARE 40x80 Cod. 33 △

Gradino		Angolare	
16,00 kg		16,50 kg	
	408084 QUARRY GOLD GRADINO 40x80 Cod. 109 ○		408088 QUARRY GOLD ANGOLARE 40x80 Cod. 113 ○
	408085 QUARRY IVORY GRADINO 40x80 Cod. 109 ○		408089 QUARRY IVORY ANGOLARE 40x80 Cod. 113 ○
	408086 QUARRY TAUPE GRADINO 40x80 Cod. 109 ○		408090 QUARRY TAUPE ANGOLARE 40x80 Cod. 113 ○
	408087 QUARRY GREY GRADINO 40x80 Cod. 109 ○		408091 QUARRY GREY ANGOLARE 40x80 Cod. 113 ○

CARATTERISTICHE DI QUALITÀ Quality characteristics Caractéristiques de qualité Qualitätseigenschaften	NORMA Norm Norme Norme	REQUISITO NORMA Required standards Valeur prescrite selon la norme Normvorgabe	RISULTATO Result Résultat Ergebniss
 Assorbimento d'acqua Water absorption of the body Absorption d'eau de support Wasseraufnahme des Scherbens	ISO 10545-3	≤ 0,5	Conforme Conformity Conforme Gemäss
 Resistenza a flessione Breaking strenght Résistance à la flexion Biegefestigkeit	ISO 10545-4	≥ 35 N/mm ²	Conforme Conformity Conforme Gemäss
 Resistenza all'abrasione Abrasion resistance Resistance a l'abrasion Abriebbeständigkeit	ISO 10545-7		PEI V
 Resistenza al gelo Frost resistance Résistance au gel Frostbeständigkeit	ISO 10545-12	Nessun campione deve presentare rotture o alterazioni apprezzabili alla superficie No samples must show ruptures or noticeable surface alteration Aucuns enchantions doit présenter ruptures ou altérations appréciables de la surface Keines der Muster sollte Risse oder sichtbare Fehler der Oberflaeche zeigen	Conforme Conformity Conforme Gemäss
 Resistenza all'attacco chimico Chemical resistance Résistance à l'attaque chimique Beständigkeit gegen chemikalien	ISO 10545-13		GA GLA
 Resistenza agli sbalzi termici Thermal shock resistance Resistance aux ecarts de température Temperaturwechselbeständigkeit	ISO 10545-5		Conforme Conformity Conforme Gemäss
 Resistenza scivolosità Sliding resistance Resistance au glissement Rutschfestigkeit	DIN 51130 R	Quarry Rettificato	R10
		Quarry Rettificato R11	R11
 Resistenza scivolosità Sliding resistance Resistance au glissement Rutschfestigkeit	DIN 51097 (A+B+C)	Quarry Rettificato R11	A+B+C
 Coefficiente d'attrito dinamico Wet dynamic coefficient of friction Coefficient de friction dynamique Reibungskoeffizient Schlupfgrigkeit (in Bewegung)	Bot 3000 E	DCOF ≥ 0,42	> 0,42
 Moderata variazione Moderate variation Variation modérée Mäßige Abweichung			V3

 V1
Aspetto uniforme
Uniform appearance
Aspect uniforme
Einheitliches Aussehen

 V2
Lieve variazione
Slight variation
Légère variation
Geringe Abweichung

 V3
Moderata variazione
Moderate variation
Variation modérée
Mäßige Abweichung

 V4
Forte stonalizzazione
Substantial variation
Effet dénuancé très accentué
Akzentuierte Variation

PER UNA POSA OTTIMALE DEL PRODOTTO CONSIGLIAMO SEMPRE DI MESCOLARE ALMENO TRE SCATOLE DI MATERIALE.

For the best product laying results, material from at least three boxes should be mixed.

Pour une pose excellente, nous recommandons toujours de mélanger le contenu d'au moins trois boîtes.

Für eine optimale Verlegung des Erzeugnisses empfehlen wir stets, mindestens drei Packungen Material anzumischen.



Tipologia
Type
Typologie
Typ
Gres porcellanato smaltato
Glazed porcelain
Grès cérame emaille
Feinsteinzeug glasiert

Formati
Sizes
Formats
Formate
60x60
30,5x60,5
30x60
15x61
15x60
10x30

Spessore
Thickness
Épaisseur
Stärke
10 mm
20mm

Formati R11
60x60 (20mm)

Resistenza scivolosità
Sliding resistance
Resistance au glissement
Rutschfestigkeit
R10 / A+B

Grado di variazione cromatica
Degree of colour change
Degré de variation chromatique
Grad der Farbabweichung
V2



606209
QUARZ ANTRACITE
RETTIFICATO 60x60
Cod. **77** □



490592
QUARZ ANTRACITE
NATURALE 30,5x60,5
Cod. **66** □



490588
QUARZ ANTRACITE
RETTIFICATO 30x60
Cod. **75** □

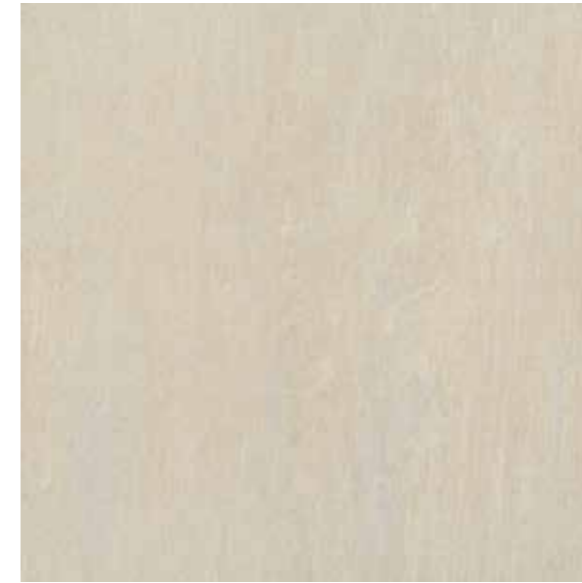

606210
QUARZ BEIGE
RETTIFICATO 60x60
Cod. **77** □



490593
QUARZ BEIGE
NATURALE 30,5x60,5
Cod. **66** □



490589
QUARZ BEIGE
RETTIFICATO 30x60
Cod. **75** □



550114
QUARZ ANTRACITE
RETTIFICATO 15x60
Cod. **79** □

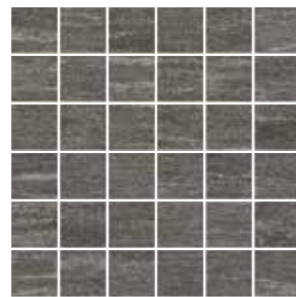

041101
QUARZ ANTRACITE
MOSAICO 5x5 SU RETE 30x30
Cod. **24** ○  11,46 kg



490596
QUARZ ANTRACITE MOSAICO WALL SU RETE 30x60
Cod. **43** ○  16,50 kg



103094
QUARZ ANTRACITE
RETTIFICATO 10x30
Cod. **120** □



150612
QUARZ GREY/ANTRACITE 3D NATURALE 15x61
Cod. **75** □



550115
QUARZ BEIGE
RETTIFICATO 15x60
Cod. **79** □

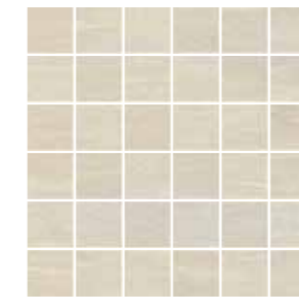

041102
QUARZ BEIGE
MOSAICO 5x5 SU RETE 30x30
Cod. **24** ○  11,46 kg



103095
QUARZ BEIGE
RETTIFICATO 10x30
Cod. **120** □



490597
QUARZ BEIGE MOSAICO WALL SU RETE 30x60
Cod. **43** ○  16,50 kg



150611
QUARZ BEIGE/TAUPE 3D NATURALE 15x61
Cod. **75** □

IMBALLI • PACKAGES • EMBALLAGES • FORMATE

	SCATOLA • BOX • BOITE • KARTON			PALLET • PALLETS • PALETTS • PALETTE		
	pz	mq	kg	box	mq	kg
60x60 (10mm)	3	1,08	22,40	40	43,20	920,00
30,5x60,5	6	1,11	21,00	40	44,40	860,00
30x60	6	1,08	22,00	40	43,20	900,00
3D 15x61	11	1,02	19,00	48	48,96	935,00
15x60	10	0,90	18,33	48	43,20	900,00
10x30	20	0,60	12,22	60	36,00	755,00

IMBALLI • PACKAGES • EMBALLAGES • FORMATE

	SCATOLA • BOX • BOITE • KARTON			PALLET • PALLETS • PALETTS • PALETTE		
	pz	mq	kg	box	mq	kg
60x60 (10mm)	3	1,08	22,40	40	43,20	920,00
30,5x60,5	6	1,11	21,00	40	44,40	860,00
30x60	6	1,08	22,00	40	43,20	900,00
3D 15x61	11	1,02	19,00	48	48,96	935,00
15x60	10	0,90	18,33	48	43,20	900,00
10x30	20	0,60	12,22	60	36,00	755,00



606211
QUARZ GREY
RETTIFICATO 60x60
Cod. **77** □



490594
QUARZ GREY
NATURALE 30,5x60,5
Cod. **66** □



490590
QUARZ GREY
RETTIFICATO 30x60
Cod. **75** □



606212
QUARZ TAUPE
RETTIFICATO 60x60
Cod. **77** □



490595
QUARZ TAUPE
NATURALE 30,5x60,5
Cod. **66** □



490591
QUARZ TAUPE
RETTIFICATO 30x60
Cod. **75** □



550116
QUARZ GREY
RETTIFICATO 15x60
Cod. **79** □



041103
QUARZ GREY
MOSAICO 5x5 SU RETE 30x30
Cod. **24** ○  11,46 kg



490598
QUARZ GREY MOSAICO WALL SU RETE 30x60
Cod. **43** ○  16,50 kg



103096
QUARZ GREY
RETTIFICATO 10x30
Cod. **120** □



150612
QUARZ GREY/ANTRACITE 3D NATURALE 15x61
Cod. **75** □



550117
QUARZ TAUPE
RETTIFICATO 15x60
Cod. **79** □



041104
QUARZ TAUPE
MOSAICO 5x5 SU RETE 30x30
Cod. **24** ○  11,46 kg



103097
QUARZ TAUPE
RETTIFICATO 10x30
Cod. **120** □



490599
QUARZ TAUPE MOSAICO WALL SU RETE 30x60
Cod. **43** ○  16,50 kg



150611
QUARZ BEIGE/TAUPE 3D NATURALE 15x61
Cod. **75** □

IMBALLI • PACKAGES • EMBALLAGES • FORMATE

	SCATOLA • BOX • BOITE • KARTON			PALLET • PALLETS • PALETTS • PALETTE		
	pz	mq	kg	box	mq	kg
60x60 (10mm)	3	1,08	22,40	40	43,20	920,00
30,5x60,5	6	1,11	21,00	40	44,40	860,00
30x60	6	1,08	22,00	40	43,20	900,00
3D 15x61	11	1,02	19,00	48	48,96	935,00
15x60	10	0,90	18,33	48	43,20	900,00
10x30	20	0,60	12,22	60	36,00	755,00

IMBALLI • PACKAGES • EMBALLAGES • FORMATE

	SCATOLA • BOX • BOITE • KARTON			PALLET • PALLETS • PALETTS • PALETTE		
	pz	mq	kg	box	mq	kg
60x60 (10mm)	3	1,08	22,40	40	43,20	920,00
30,5x60,5	6	1,11	21,00	40	44,40	860,00
30x60	6	1,08	22,00	40	43,20	900,00
3D 15x61	11	1,02	19,00	48	48,96	935,00
15x60	10	0,90	18,33	48	43,20	900,00
10x30	20	0,60	12,22	60	36,00	755,00



606193
QUARZ ANTRACITE 2 CM 60x60 RETTIFICATO
Cod. **94** □

20 mm



606194
QUARZ BEIGE 2 CM 60x60 RETTIFICATO
Cod. **94** □

20 mm



606195
QUARZ GREY 2 CM 60x60 RETTIFICATO
Cod. **94** □

20 mm



606196
QUARZ TAUPE 2 CM 60x60 RETTIFICATO
Cod. **94** □

20 mm

IMBALLI • PACKAGES • EMBALLAGES • FORMATE

	SCATOLA • BOX • BOITE • KARTON			PALLET • PALLETS • PALETTS • PALETTE		
	pz	mq	kg	box	mq	kg

60x60 (20mm)	2	0,72	30,10	32	23,04	985,00
---------------------	---	------	-------	----	-------	--------

Battiscopa

40
11,60 kg

20
11,60 kg



290697
QUARZ ANTRACITE
RETTIFICATO BATTISCOPA 5x30
Cod. **116** △

290698
QUARZ BEIGE
RETTIFICATO BATTISCOPA 5x30
Cod. **116** △

290699
QUARZ GREY
RETTIFICATO BATTISCOPA 5x30
Cod. **116** △

290700
QUARZ TAUPE
RETTIFICATO BATTISCOPA 5x30
Cod. **116** △

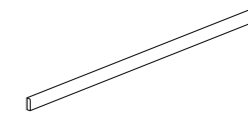

290701
QUARZ ANTRACITE
RETTIFICATO BATTISCOPA 5x60
Cod. **121** △

290702
QUARZ BEIGE
RETTIFICATO BATTISCOPA 5x60
Cod. **121** △

290703
QUARZ GREY
RETTIFICATO BATTISCOPA 5x60
Cod. **121** △

290704
QUARZ TAUPE
RETTIFICATO BATTISCOPA 5x60
Cod. **121** △

Gradino

2
9,50 kg

2
9,80 kg

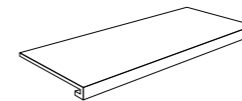

490631
QUARZ ANTRACITE
RETTIFICATO GRADINO 33x60
Cod. **112** ○

490632
QUARZ BEIGE
RETTIFICATO GRADINO 33x60
Cod. **112** ○

490633
QUARZ GREY
RETTIFICATO GRADINO 33x60
Cod. **112** ○

490634
QUARZ TAUPE
RETTIFICATO GRADINO 33x60
Cod. **112** ○

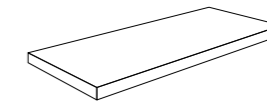

490642
QUARZ ANTRACITE
RETTIFICATO ANGOLARE 33x60
Cod. **107** ○

490643
QUARZ BEIGE
RETTIFICATO ANGOLARE 33x60
Cod. **107** ○

490644
QUARZ GREY
RETTIFICATO ANGOLARE 33x60
Cod. **107** ○

490645
QUARZ TAUPE
RETTIFICATO ANGOLARE 33x60
Cod. **107** ○

Angolare



CARATTERISTICHE DI QUALITÀ Quality characteristics Caractéristiques de qualité Qualitätseigenschaften	NORMA Norm Norme Norme	REQUISITO NORMA Required standards Valeur prescrite selon la norme Normvorgabe	RISULTATO Result Résultat Ergebniss
Assorbimento d'acqua Water absorption of the body Absorption d'eau de support Wasseraufnahme des Scherbens	ISO 10545-3	≤ 0,5	Conforme Conformity Conforme Gemäss
Resistenza a flessione Breaking strenght Résistance à la flexion Biegefestigkeit	ISO 10545-4	≥ 35 N/mm ²	Conforme Conformity Conforme Gemäss
Resistenza all'abrasione Abrasion resistance Resistance a l'abrasion Abriebbeständigkeit	ISO 10545-7		PEI V
Resistenza al gelo Frost resistance Résistance au gel Frostbeständigkeit	ISO 10545-12	Nessun campione deve presentare rotture o alterazioni apprezzabili alla superficie No samples must show ruptures or noticeable surface alteration Aucuns enchantions doit présenter ruptures ou altérations appréciables de la surface Keines der Muster sollte Risse oder sichtbare Fehler der Oberfläche zeigen	Conforme Conformity Conforme Gemäss
Resistenza all'attacco chimico Chemical resistance Résistance à l'attaque chimique Beständigkeit gegen chemikalien	ISO 10545-13		GA GLA
Resistenza agli sbalzi termici Thermal shock resistance Resistance aux écarts de température Temperaturwechselbeständigkeit	ISO 10545-5		Conforme Conformity Conforme Gemäss
Resistenza scivolosità Sliding resistance Resistance au glissement Rutschfestigkeit	DIN 51130 R		R10 R11 60x60 (20mm)
Resistenza scivolosità Sliding resistance Resistance au glissement Rutschfestigkeit	DIN 51097 (A+B+C)		A+B
Coefficiente d'attrito dinamico Wet dynamic coefficient of friction Coefficient de friction dynamique Reibungskoeffizient Schlupfgrigkeit (in Bewegung)	Bot 3000 E	DCOF ≥ 0,42	> 0,42
Lieve variazione Slight variation Légère variation Geringe Abweichung			V2

V1
Aspetto uniforme
Uniform appearance
Aspect uniforme
Einheitliches Aussehen

V2
Lieve variazione
Slight variation
Légère variation
Geringe Abweichung

V3
Moderata variazione
Moderate variation
Variation modérée
Mäßige Abweichung

V4
Forte stonalizzazione
Substantial variation
Effet dénuancé très accentué
Akzentuierte Variation

PER UNA POSA OTTIMALE DEL PRODOTTO CONSIGLIAMO SEMPRE DI MESCOLARE ALMENO TRE SCATOLE DI MATERIALE.

For the best product laying results, material from at least three boxes should be mixed.

Pour une pose excellente, nous recommandons toujours de mélanger le contenu d'au moins trois boîtes.

Für eine optimale Verlegung des Erzeugnisses empfehlen wir stets, mindestens drei Packungen Material anzumischen.



Tipologia
Type
Typologie
Typ
Gres porcellanato smaltato
Glazed porcelain
Grès cérame emaille
Feinsteinzeug glasiert

Formati
Sizes
Formats
Formate
60x60
30x60
15x60
30x30
10x30
15x15
7,5x15
10x10

Spessore
Thickness
Épaisseur
Stärke
10 mm

Resistenza scivolosità
Sliding resistance
Resistance au glissement
Rutschfestigkeit
R9

Grado di variazione cromatica
Degree of colour change
Degré de variation chromatique
Grad der Farbabweichung
V3



606153
ROYAL MARBLES LIGHT BARDIGLIO RETTIFICATO 60x60
Cod. **79** □

606155
ROYAL MARBLES LIGHT BARDIGLIO LAPPATO RETTIFICATO 60x60
Cod. **93** □



490488
ROYAL MARBLES LIGHT BARDIGLIO RETTIFICATO 30x60
Cod. **76** □

490490
ROYAL MARBLES LIGHT BARDIGLIO LAPPATO RETTIFICATO 30x60
Cod. **85** □



550103
ROYAL MARBLES LIGHT BARDIGLIO RETTIFICATO 15x60
Cod. **95** □

550104
ROYAL MARBLES LIGHT BARDIGLIO LAPPATO RETTIFICATO 15x60
Cod. **111** □

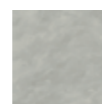

450373
ROYAL MARBLES LIGHT BARDIGLIO
RETTIFICATO (sfuso) 10x10 Cod. **90** □

450374
ROYAL MARBLES LIGHT BARDIGLIO
LAPPATO RETTIFICATO (sfuso) 10x10 Cod. **106** □

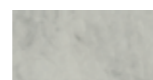

040973
ROYAL MARBLES LIGHT BARDIGLIO
(sfuso) 7,5x15 Cod. **95** □

040974
ROYAL MARBLES LIGHT BARDIGLIO
LAPPATO (sfuso) 7,5x15 Cod. **111** □

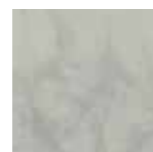

230253
ROYAL MARBLES LIGHT BARDIGLIO
RETTIFICATO 15x15 Cod. **78** □

230254
ROYAL MARBLES LIGHT BARDIGLIO
LAPPATO RETTIFICATO 15x15 Cod. **90** □



040967
ROYAL MARBLES LIGHT BARDIGLIO
RETTIFICATO 30x30 Cod. **78** □

040968
ROYAL MARBLES LIGHT BARDIGLIO
LAPPATO RETTIFICATO 30x30 Cod. **90** □



103074
ROYAL MARBLES LIGHT BARDIGLIO
RETTIFICATO 10x30 Cod. **77** □

103075
ROYAL MARBLES LIGHT BARDIGLIO
LAPPATO RETTIFICATO 10x30 Cod. **93** □

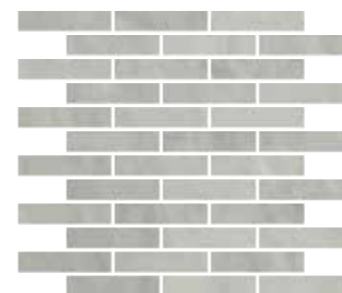

18,80 kg

040997
ROYAL MARBLES LIGHT BARDIGLIO
MURETTO 2,4x10 SU RETE 30x30
Cod. **46** ○

040998
ROYAL MARBLES LIGHT BARDIGLIO LAPPATO
MURETTO 2,4x10 SU RETE 30x30
Cod. **58** ○



12,30 kg

040991
ROYAL MARBLES LIGHT BARDIGLIO
MOSAICO 5x5 SU RETE 30x30
Cod. **24** ○

040992
ROYAL MARBLES LIGHT BARDIGLIO LAPPATO
MOSAICO 5x5 SU RETE 30x30
Cod. **31** ○



10,30 kg

040979
ROYAL MARBLES LIGHT BARDIGLIO
MOSAICO ESAGONO SU RETE 27x28
Cod. **136** ○

040980
ROYAL MARBLES LIGHT BARDIGLIO LAPPATO
MOSAICO ESAGONO SU RETE 27x28
Cod. **49** ○



18,80 kg

040985
ROYAL MARBLES LIGHT BARDIGLIO
MOSAICO BASKETWAVE SU RETE 30x30
Cod. **47** ○

040986
ROYAL MARBLES LIGHT BARDIGLIO LAPPATO
MOSAICO BASKETWAVE SU RETE 30x30
Cod. **60** ○



6,43 kg

380224
ROYAL MARBLES LIGHT BARDIGLIO
NATURALE LONDON 5x30
Cod. **33** ○

380225
ROYAL MARBLES LIGHT BARDIGLIO
LUCIDO LONDON 5x30
Cod. **33** ○



4,50 kg

380230
ROYAL MARBLES LIGHT BARDIGLIO
BORDURA MURETTO SU RETE 7x30
Cod. **28** ○

380231
ROYAL MARBLES LIGHT BARDIGLIO LAPPATO
BORDURA MURETTO SU RETE 7x30
Cod. **28** ○

IMBALLI • PACKAGES • EMBALLAGES • FORMATE

	SCATOLA • BOX • BOITE • KARTON			PALLET • PALLETS • PALETTS • PALETTE		
	pz	mq	kg	box	mq	kg
60x60	3	1,08	24,10	40	43,20	980,00
30x60	6	1,08	24,48	40	43,20	980,00
15x60	10	0,90	19,60	48	43,20	940,00
30x30	11	0,99	23,20	46	45,54	1.070,00
10x30	20	0,60	15,00	60	36,00	920,00
15x15	46	1,035	20,20	33	34,15	665,00
7,5x15	50	0,56	11,30	76	42,56	858,80
10x10	50	0,50	8,70	36	18,00	315,00



606154
ROYAL MARBLES MARFIL SELECT RETTIFICATO 60x60
Cod. **79** □

606156
ROYAL MARBLES MARFIL SELECT LAPPATO RETTIFICATO 60x60
Cod. **93** □



490489
ROYAL MARBLES MARFIL SELECT RETTIFICATO 30x60
Cod. **76** □

490491
ROYAL MARBLES MARFIL SELECT LAPPATO RETTIFICATO 30x60
Cod. **85** □

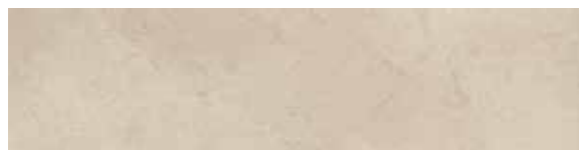

550105
ROYAL MARBLES MARFIL SELECT RETTIFICATO 15x60
Cod. **95** □

550106
ROYAL MARBLES MARFIL SELECT LAPPATO RETTIFICATO 15x60
Cod. **111** □



450375
ROYAL MARBLES MARFIL SELECT
RETTIFICATO (sfuso) 10x10 Cod. **90** □

450376
ROYAL MARBLES MARFIL SELECT
LAPPATO RETTIFICATO (sfuso) 10x10 Cod. **106** □



040975
ROYAL MARBLES MARFIL SELECT
(sfuso) 7,5x15 Cod. **95** □

040976
ROYAL MARBLES MARFIL SELECT
LAPPATO (sfuso) 7,5x15 Cod. **111** □



230255
ROYAL MARBLES MARFIL SELECT
RETTIFICATO 15x15 Cod. **78** □

230256
ROYAL MARBLES MARFIL SELECT
LAPPATO RETTIFICATO 15x15 Cod. **90** □



040969
ROYAL MARBLES MARFIL SELECT
RETTIFICATO 30x30 Cod. **78** □

040970
ROYAL MARBLES MARFIL SELECT
LAPPATO RETTIFICATO 30x30 Cod. **90** □



103076
ROYAL MARBLES MARFIL SELECT
RETTIFICATO 10x30 Cod. **77** □

103077
ROYAL MARBLES MARFIL SELECT
LAPPATO RETTIFICATO 10x30 Cod. **93** □

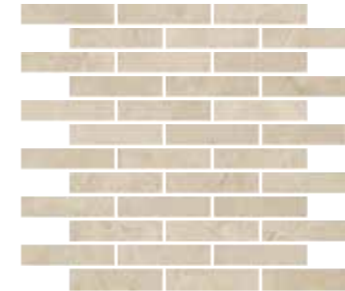

040999
ROYAL MARBLES MARFIL SELECT
MURETTO 2,4x10 SU RETE 30x30
Cod. **46** ○

041000
ROYAL MARBLES MARFIL SELECT LAPPATO
MURETTO 2,4x10 SU RETE 30x30
Cod. **58** ○



18,80 kg

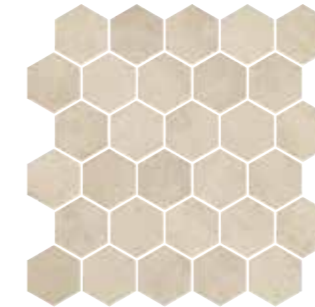

040981
ROYAL MARBLES MARFIL SELECT MOSAICO
ESAGONO SU RETE 27x28
Cod. **136** ○

040982
ROYAL MARBLES MARFIL SELECT LAPPATO
MOSAICO ESAGONO SU RETE 27x28
Cod. **49** ○



10,30 kg



040993
ROYAL MARBLES MARFIL SELECT
MOSAICO 5x5 SU RETE 30x30
Cod. **24** ○

040994
ROYAL MARBLES MARFIL SELECT LAPPATO
MOSAICO 5x5 SU RETE 30x30
Cod. **31** ○



12,30 kg



041177
ROYAL MARBLES MARFIL SELECT NATURALE
MOSAICO ARABESQUE SU RETE 30x30
Cod. **57** ○

041178
ROYAL MARBLES MARFIL SELECT LAPPATO
MOSAICO ARABESQUE SU RETE 30x30
Cod. **72** ○



12,00 kg

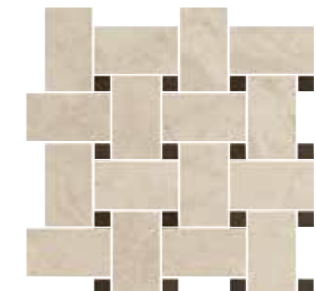

040987
ROYAL MARBLES MARFIL SELECT
MOSAICO BASKETWAVE SU RETE 30x30
Cod. **47** ○

040988
ROYAL MARBLES MARFIL SELECT LAPPATO
MOSAICO BASKETWAVE SU RETE 30x30
Cod. **60** ○



18,80 kg



380226
ROYAL MARBLES MARFIL SELECT
NATURALE LONDON 5x30
Cod. **33** ○

380227
ROYAL MARBLES MARFIL SELECT
LUCIDO LONDON 5x30
Cod. **33** ○



6,43 kg



380232
ROYAL MARBLES MARFIL SELECT
BORDURA MURETTO SU RETE 7x30
Cod. **28** ○

380233
ROYAL MARBLES MARFIL SELECT LAPPATO
BORDURA MURETTO SU RETE 7x30
Cod. **28** ○



4,50 kg

IMBALLI • PACKAGES • EMBALLAGES • FORMATE

	SCATOLA • BOX • BOITE • KARTON			PALLET • PALLETS • PALETTS • PALETTE		
	pz	mq	kg	box	mq	kg
60x60	3	1,08	24,10	40	43,20	980,00
30x60	6	1,08	24,48	40	43,20	980,00
15x60	10	0,90	19,60	48	43,20	940,00
30x30	11	0,99	23,20	46	45,54	1.070,00
10x30	20	0,60	15,00	60	36,00	920,00
15x15	46	1,035	20,20	33	34,15	665,00
7,5x15	50	0,56	11,30	76	42,56	858,80
10x10	50	0,50	8,70	36	18,00	315,00



606157
ROYAL MARBLES ROYAL GOLD RETTIFICATO 60x60
Cod. **79** □

606158
ROYAL MARBLES ROYAL GOLD LAPPATO RETTIFICATO 60x60
Cod. **93** □



490492
ROYAL MARBLES ROYAL GOLD RETTIFICATO 30x60
Cod. **76** □

490493
ROYAL MARBLES ROYAL GOLD LAPPATO RETTIFICATO 30x60
Cod. **85** □



550107
ROYAL MARBLES ROYAL GOLD RETTIFICATO 15x60
Cod. **95** □

550108
ROYAL MARBLES ROYAL GOLD LAPPATO RETTIFICATO 15x60
Cod. **111** □



450377
ROYAL MARBLES ROYAL GOLD
RETTIFICATO (sfuso) 10x10 Cod. **90** □

450378
ROYAL MARBLES ROYAL GOLD
LAPPATO RETTIFICATO (sfuso) 10x10 Cod. **106** □



040977
ROYAL MARBLES ROYAL GOLD
(sfuso) 7,5x15 Cod. **95** □

040978
ROYAL MARBLES ROYAL GOLD
LAPPATO (sfuso) 7,5x15 Cod. **111** □



230257
ROYAL MARBLES ROYAL GOLD
RETTIFICATO 15x15 Cod. **78** □

230258
ROYAL MARBLES ROYAL GOLD
LAPPATO RETTIFICATO 15x15 Cod. **90** □

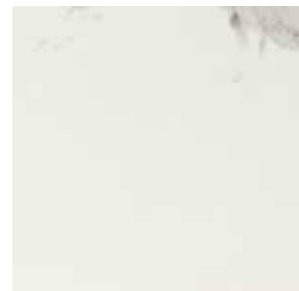

040971
ROYAL MARBLES ROYAL GOLD
RETTIFICATO 30x30 Cod. **78** □

040972
ROYAL MARBLES ROYAL GOLD
LAPPATO RETTIFICATO 30x30 Cod. **90** □



103078
ROYAL MARBLES ROYAL GOLD
RETTIFICATO 10x30 Cod. **77** □

103079
ROYAL MARBLES ROYAL GOLD
LAPPATO RETTIFICATO 10x30 Cod. **93** □

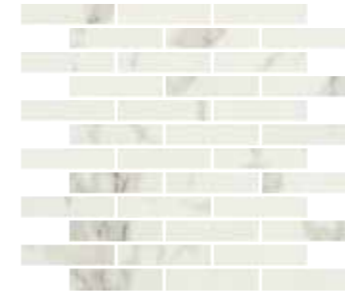

041001
ROYAL MARBLES ROYAL GOLD
MURETTO 2,4x10 SU RETE 30x30
Cod. **46** ○

041002
ROYAL MARBLES ROYAL GOLD LAPPATO
MURETTO 2,4x10 SU RETE 30x30
Cod. **58** ○



040995
ROYAL MARBLES ROYAL GOLD
MOSAICO 5x5 SU RETE 30x30
Cod. **24** ○

040996
ROYAL MARBLES ROYAL GOLD LAPPATO
MOSAICO 5x5 SU RETE 30x30
Cod. **31** ○



18,80 kg



040983
ROYAL MARBLES ROYAL GOLD MOSAICO
ESAGONO SU RETE 27x28
Cod. **136** ○

040984
ROYAL MARBLES ROYAL GOLD LAPPATO
MOSAICO ESAGONO SU RETE 27x28
Cod. **49** ○



10,30 kg



041175
ROYAL MARBLES ROYAL GOLD NATURALE
MOSAICO ARABESQUE SU RETE 30x30
Cod. **57** ○

041176
ROYAL MARBLES ROYAL GOLD LAPPATO
MOSAICO ARABESQUE SU RETE 30x30
Cod. **72** ○



12,00 kg



040989
ROYAL MARBLES ROYAL GOLD
MOSAICO BASKETWAVE SU RETE 30x30
Cod. **47** ○

040990
ROYAL MARBLES ROYAL GOLD LAPPATO
MOSAICO BASKETWAVE SU RETE 30x30
Cod. **60** ○



18,80 kg



380228
ROYAL MARBLES ROYAL GOLD
NATURALE LONDON 5x30
Cod. **33** ○

380229
ROYAL MARBLES ROYAL GOLD
LUCIDO LONDON 5x30
Cod. **33** ○



6,43 kg



380234
ROYAL MARBLES ROYAL GOLD
BORDURA MURETTO SU RETE 7x30
Cod. **28** ○

380235
ROYAL MARBLES ROYAL GOLD LAPPATO
BORDURA MURETTO SU RETE 7x30
Cod. **28** ○



4,50 kg

IMBALLI • PACKAGES • EMBALLAGES • FORMATE

	SCATOLA • BOX • BOITE • KARTON			PALLET • PALLETS • PALETTS • PALETTE		
	pz	mq	kg	box	mq	kg
60x60	3	1,08	24,10	40	43,20	980,00
30x60	6	1,08	24,48	40	43,20	980,00
15x60	10	0,90	19,60	48	43,20	940,00
30x30	11	0,99	23,20	46	45,54	1.070,00
10x30	20	0,60	15,00	60	36,00	920,00
15x15	46	1,035	20,20	33	34,15	665,00
7,5x15	50	0,56	11,30	76	42,56	858,80
10x10	50	0,50	8,70	36	18,00	315,00



royal marbles RETT. LAPPATO

La finitura lappata è consigliata per uso rivestimento o per pavimenti da bagno in ambito residenziale. Nello specifico il tipo di pavimentazione deve essere non soggetta ad eccessive sollecitazioni e mai a diretto contatto con aree esterne. Come si verifica comunemente nelle pietre naturali l'eventuale presenza di puntini sulla superficie o di qualche disuniformità della lucentezza sono da considerare caratteristiche del prodotto derivanti dalla lavorazione a cui viene sottoposto.

The polished finish is recommended for wall coverings or for the floors of residential bathrooms. Specifically, floor coverings in this material must not be subjected to excessively heavy traffic and must never be in direct contact with outdoor areas. As is often the case with natural stones, any spots on the surface or any unevenness in shine are typical characteristics of the product, deriving from the process used.

La finition polie est recommandée pour le revêtement sol et mur des salles de bains résidentielles. Notamment, ce type de carreau au sol ne doit pas être exposé à des contraintes excessives, et il ne doit jamais être en contact direct avec des zones extérieures. Comme cela est souvent le cas pour les pierres naturelles, les micro trous éventuellement présents à la surface du produit ou l'hétérogénéité de son éclat forment des caractéristiques propres au façonnage.

Die polierte Oberfläche wird für Wandverkleidungen und Bodenbeläge in Privatbädern empfohlen. Der Bodenbelag darf keinen starken Beanspruchungen ausgesetzt sein und keinen direkten Kontakt zu Außenbereichen haben. Wie bei Natursteinen üblich, kann die Oberfläche Körnungen oder einen unregelmäßigen Glanz aufweisen. Diese Merkmale sind typische, beabsichtigte Produkteigenschaften, die durch das Bearbeitungsverfahren hervorgerufen werden.

Pezzi speciali • Special trims • Pièces spéciales • Formstücke

Battiscopa



23,60 kg



23,60 kg

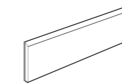

290628
ROYAL MARBLES LIGHT BARDIGLIO
BATTISCOPA NATURALE 7x30
Cod. **116** △

290630
ROYAL MARBLES MARFIL SELECT
BATTISCOPA NATURALE 7x30
Cod. **116** △

290632
ROYAL MARBLES ROYAL GOLD
BATTISCOPA NATURALE 7x30
Cod. **116** △

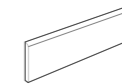

290629
ROYAL MARBLES LIGHT BARDIGLIO
BATTISCOPA LAPPATO 7x30
Cod. **22** △

290631
ROYAL MARBLES MARFIL SELECT
BATTISCOPA LAPPATO 7x30
Cod. **22** △

290633
ROYAL MARBLES ROYAL GOLD
BATTISCOPA LAPPATO 7x30
Cod. **22** △

CARATTERISTICHE DI QUALITÀ QUALITY CHARACTERISTICS CARACTÉRISTIQUES DE QUALITÉ QUALITÄTSEIGENSCHAFTEN	NORMA NORM NORME NORME	REQUISITO NORMA REQUIRED STANDARDS VALEUR PRESCRITE SELON LA NORME NORMVORGABE	RISULTATO RESULT RÉSULTAT ERGEBNISS
Assorbimento d'acqua Water absorption of the body Absorption d'eau de support Wasseraufnahme des Scherbens	ISO 10545-3	≤ 0,5	Conforme Conformity Conforme Gemäss
Resistenza a flessione Breaking strenght Résistance à la flexion Biegefestigkeit	ISO 10545-4	≥ 35 N/mm ²	Conforme Conformity Conforme Gemäss
Resistenza all'abrasione Abrasion resistance Resistance à l'abrasion Abriebbeständigkeit	ISO 10545-7	Royal Marbles Rettificato Royal Marbles Lappato	PEI IV
Resistenza al gelo Frost resistance Résistance au gel Frostbeständigkeit	ISO 10545-12	Nessun campione deve presentare rotture o alterazioni apprezzabili alla superficie No samples must show ruptures or noticeable surface alteration Aucuns enchanions doit présenter ruptures ou altérations appréciables de la surface Keines der Muster sollte Risse oder sichtbare Fehler der Oberflaeche zeigen	Conforme Conformity Conforme Gemäss
Resistenza all'attacco chimico Chemical resistance Résistance à l'attaque chimique Beständigkeit gegen chemikalien	ISO 10545-13	Royal Marbles Rettificato Royal Marbles Lappato	GA GLA GA GLB
Resistenza agli sbalzi termici Thermal shock resistance Resistance aux écarts de température Temperaturwechselbeständigkeit	ISO 10545-5		Conforme Conformity Conforme Gemäss
Resistenza scivolosità Sliding resistance Resistance au glissement Rutschfestigkeit	DIN 51130 R	Royal Marbles Rettificato Royal Marbles Lappato	R9
Moderata variazione Moderate variation Variation modérée Mäßige Abweichung			V3

Aspetto uniforme
Uniform appearance
Aspect uniforme
Einheitliches Aussehen
V1

Lieve variazione
Slight variation
Légère variation
Geringe Abweichung
V2

Moderata variazione
Moderate variation
Variation modérée
Mäßige Abweichung
V3

Forte stonizzazione
Substantial variation
Effet dénuancé très accentué
Akzentuierte Variation
V4

PER UNA POSA OTTIMALE DEL PRODOTTO CONSIGLIAMO SEMPRE DI MESCOLARE ALMENO TRE SCATOLE DI MATERIALE.

For the best product laying results, material from at least three boxes should be mixed.

Pour une pose excellente, nous recommandons toujours de mélanger le contenu d'au moins trois boîtes.

Für eine optimale Verlegung des Erzeugnisses empfehlen wir stets, mindestens drei Packungen Material anzumischen.



Tipologia
Type
Typologie
Typ
Gres porcellanato smaltato
Glazed porcelain
Grès cérame emaille
Feinsteinzeug glasiert

Formati R10 A+B
Sizes
Formats
Formate
60x120
20x120
40x80
20x80
60x60
30x60
30x30
10x30
5x20

Spessore
Thickness
Épaisseur
Stärke
10 mm
20mm

Formati R11 A+B+C
30x60
40x80 (20mm)

Resistenza scivolosità
Sliding resistance
Resistance au glissement
Rutschfestigkeit
R10 / A+B
R11 / A+B+C

Grado di variazione cromatica
Degree of colour change
Degré de variation chromatique
Grad der Farbabweichung
V3



601238
SLIDE BLACK RETTIFICATO 60x120
Cod. **94** □



201216
SLIDE BLACK RETTIFICATO 20x120
Cod. **111** □



606165
SLIDE BLACK RETTIFICATO 60x60
Cod. **79** □



490500
SLIDE BLACK RETTIFICATO 30x60
Cod. **76** □

490504
SLIDE BLACK RETTIFICATO **R11** 30x60
Cod. **77** □



041015
SLIDE BLACK RETTIFICATO 30x30
Cod. **78** □



103085
SLIDE BLACK RETTIFICATO 10x30
Cod. **77** □



408111
SLIDE BLACK RETTIFICATO 40x80
Cod. **79** □



208043
SLIDE BLACK RETTIFICATO 20x80
Cod. **89** □



041027
SLIDE BLACK MOSAICO ESAGONO
LATO 4,5 SU RETE 26x30
Cod. **128** ○



6,00 kg



272902
SLIDE INTARSIO HYDRO BLACK-WHITE
10,5x10,5 SU RETE 21x21 Cod. **62** ○



3,00 kg



050214
SLIDE BLACK 5x20
Cod. **93** □



310196
SLIDE BLACK LONDON 3,5x30
Cod. **33** ○



2,80 kg

IMBALLI • PACKAGES • EMBALLAGES • FORMATE

	SCATOLA • BOX • BOITE • KARTON			PALLET • PALLETS • PALETTS • PALETTE		
	pz	m ^q	kg	box	m ^q	kg
60x120	2	1,44	33,00	30	43,20	1.015,00
20x120	4	0,96	21,60	30	28,80	670,00
40x80	3	0,96	23,12	56	53,76	1.320,00
20x80	6	0,96	21,80	42	40,32	940,00
60x60	3	1,08	24,00	40	43,20	990,00
30x60-30x60 R11	6	1,08	24,00	40	43,20	990,00
30x30	11	0,99	23,00	46	45,54	1.085,00
10x30	20	0,60	15,00	60	36,00	920,00
5x20	56	0,56	11,70	60	33,60	730,00



041018
SLIDE BLACK MOSAICO 5x5
SU RETE 30x30 Cod. **24** ○



12,30 kg

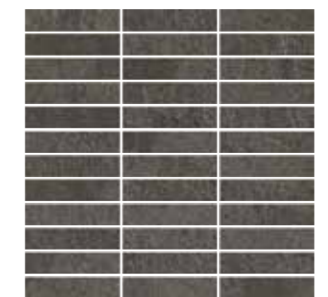

041021
SLIDE BLACK MOSAICO 2,4x10
SU RETE 30x30 Cod. **46** ○



19,60 kg

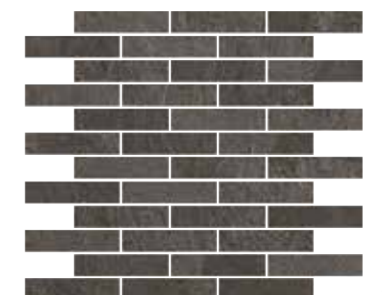

041024
SLIDE BLACK MOSAICO MURETTO 2,4x10
SU RETE 30x30 Cod. **46** ○



19,60 kg



380241
SLIDE BLACK BORDURA WAVE 7x30
Cod. **16** ○



3,25 kg



380238
SLIDE BLACK BORDURA WAVE 14x30
Cod. **33** ○



3,25 kg



601239
SLIDE GREY RETTIFICATO 60x120
Cod. **94** □



201217
SLIDE GREY RETTIFICATO 20x120
Cod. **111** □



606166
SLIDE GREY RETTIFICATO 60x60
Cod. **79** □



490501
SLIDE GREY RETTIFICATO 30x60
Cod. **76** □

490505
SLIDE GREY RETTIFICATO **R11** 30x60
Cod. **77** □



041016
SLIDE GREY RETTIFICATO 30x30
Cod. **78** □



103086
SLIDE GREY RETTIFICATO 10x30
Cod. **77** □



408112
SLIDE GREY RETTIFICATO 40x80
Cod. **79** □



208044
SLIDE GREY RETTIFICATO 20x80
Cod. **89** □



041028
SLIDE GREY MOSAICO ESAGONO
LATO 4,5 SU RETE 26x30
Cod. **128** ○



6,00 kg



272901
SLIDE INTARSIO HYDRO GREY-WHITE
10,5x10,5 SU RETE 21x21 Cod. **62** ○



3,00 kg

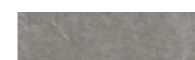

050215
SLIDE GREY 5x20
Cod. **93** □



310197
SLIDE GREY LONDON 3,5x30
Cod. **33** ○



2,80 kg

IMBALLI • PACKAGES • EMBALLAGES • FORMATE

	SCATOLA • BOX • BOITE • KARTON			PALLET • PALLETS • PALETTS • PALETTE		
	pz	mq	kg	box	mq	kg
60x120	2	1,44	33,00	30	43,20	1.015,00
20x120	4	0,96	21,60	30	28,80	670,00
40x80	3	0,96	23,12	56	53,76	1.320,00
20x80	6	0,96	21,80	42	40,32	940,00
60x60	3	1,08	24,00	40	43,20	990,00
30x60-30x60 R11	6	1,08	24,00	40	43,20	990,00
30x30	11	0,99	23,00	46	45,54	1.085,00
10x30	20	0,60	15,00	60	36,00	920,00
5x20	56	0,56	11,70	60	33,60	730,00

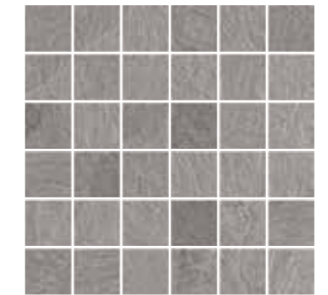

12,30 kg

041019
SLIDE GREY MOSAICO 5x5
SU RETE 30x30 Cod. **24** ○

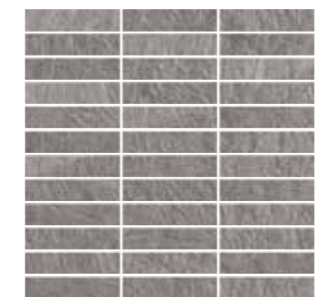

19,60 kg

041022
SLIDE GREY MOSAICO 2,4x10
SU RETE 30x30 Cod. **46** ○



19,60 kg

041025
SLIDE GREY MOSAICO MURETTO 2,4x10
SU RETE 30x30 Cod. **46** ○



3,25 kg

380242
SLIDE GREY BORDURA WAVE 7x30
Cod. **16** ○



3,25 kg

380239
SLIDE GREY BORDURA WAVE 14x30
Cod. **33** ○



601240
SLIDE WHITE RETTIFICATO 60x120
Cod. **94** □



201218
SLIDE WHITE RETTIFICATO 20x120
Cod. **111** □



606167
SLIDE WHITE RETTIFICATO 60x60
Cod. **79** □



490502
SLIDE WHITE RETTIFICATO 30x60
Cod. **76** □

490506
SLIDE WHITE RETTIFICATO **R11** 30x60
Cod. **77** □

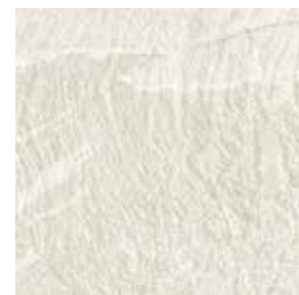

041017
SLIDE WHITE RETTIFICATO 30x30
Cod. **78** □

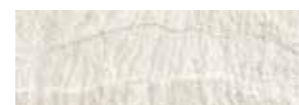

103087
SLIDE WHITE RETTIFICATO 10x30
Cod. **77** □



408113
SLIDE WHITE RETTIFICATO 40x80
Cod. **79** □



208045
SLIDE WHITE RETTIFICATO 20x80
Cod. **89** □



041029
SLIDE WHITE MOSAICO ESAGONO
LATO 4,5 SU RETE 26x30
Cod. **128** ○



050216
SLIDE WHITE 5x20
Cod. **93** □



272901
SLIDE INTARSIO HYDRO GREY-WHITE
10,5x10,5 SU RETE 21x21 Cod. **62** ○



272902
SLIDE INTARSIO HYDRO BLACK-WHITE
10,5x10,5 SU RETE 21x21 Cod. **62** ○

IMBALLI • PACKAGES • EMBALLAGES • FORMATE

	SCATOLA • BOX • BOITE • KARTON			PALLET • PALLETS • PALETTS • PALETTE		
	pz	m ^q	kg	box	m ^q	kg
60x120	2	1,44	33,00	30	43,20	1.015,00
20x120	4	0,96	21,60	30	28,80	670,00
40x80	3	0,96	23,12	56	53,76	1.320,00
20x80	6	0,96	21,80	42	40,32	940,00
60x60	3	1,08	24,00	40	43,20	990,00
30x60-30x60 R11	6	1,08	24,00	40	43,20	990,00
30x30	11	0,99	23,00	46	45,54	1.085,00
10x30	20	0,60	15,00	60	36,00	920,00
5x20	56	0,56	11,70	60	33,60	730,00



041020
SLIDE WHITE MOSAICO 5x5
SU RETE 30x30 Cod. **24** ○

6
12,30 kg



041023
SLIDE WHITE MOSAICO 2,4x10
SU RETE 30x30 Cod. **46** ○

11
19,60 kg



310198
SLIDE WHITE LONDON 3,5x30
Cod. **33** ○

24
2,80 kg



041026
SLIDE WHITE MOSAICO MURETTO 2,4x10
SU RETE 30x30 Cod. **46** ○

11
19,60 kg



380243
SLIDE WHITE BORDURA WAVE 7x30
Cod. **16** ○

12
3,25 kg



380240
SLIDE WHITE BORDURA WAVE 14x30
Cod. **33** ○

6
3,25 kg



408115
SLIDE BLACK 2 CM RETTIFICATO 40x80
Cod. 105 □

20 mm



408116
SLIDE GREY 2 CM RETTIFICATO 40x80
Cod. 105 □

20 mm



408117
SLIDE WHITE 2 CM RETTIFICATO 40x80
Cod. 105 □

20 mm









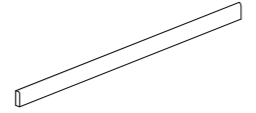
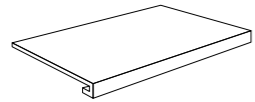
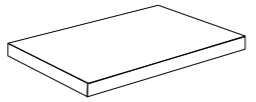
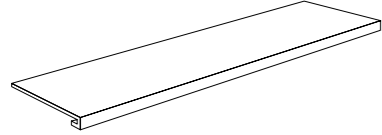
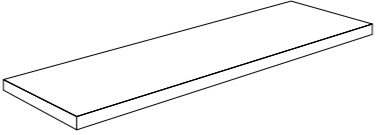
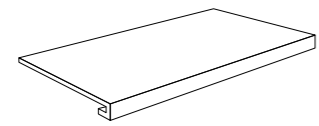
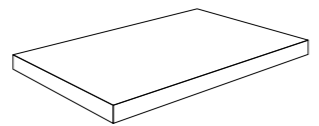



IMBALLI • PACKAGES • EMBALLAGES • FORMATE

	SCATOLA • BOX • BOITE • KARTON			PALLET • PALLETS • PALETTS • PALETTE		
	<i>pz</i>	<i>mq</i>	<i>kg</i>	<i>box</i>	<i>mq</i>	<i>kg</i>
40x80 (20mm)	2	0,64	31	24	15,36	765,00

Pezzi speciali • Special trims • Pièces spéciales • Formstücke

Battiscopa		40 9,00 kg	20 9,00 kg
	290644 SLIDE BLACK BATTISCOPIA 5x30 Cod. 116 △		290647 SLIDE BLACK BATTISCOPIA 5x60 Cod. 121 △
	290645 SLIDE GREY BATTISCOPIA 5x30 Cod. 116 △		290648 SLIDE GREY BATTISCOPIA 5x60 Cod. 121 △
	290646 SLIDE WHITE BATTISCOPIA 5x30 Cod. 116 △		290649 SLIDE WHITE BATTISCOPIA 5x60 Cod. 121 △
Gradino		2 10,00 kg	2 11,00 kg
	490530 SLIDE BLACK GRADINO 33x60 Cod. 112 ○		490548 SLIDE BLACK ANGOLARE 33x60 Cod. 107 ○
	490531 SLIDE GREY GRADINO 33x60 Cod. 112 ○		490549 SLIDE GREY ANGOLARE 33x60 Cod. 107 ○
	490532 SLIDE WHITE GRADINO 33x60 Cod. 112 ○		490550 SLIDE WHITE ANGOLARE 33x60 Cod. 107 ○
Gradino		2 20,00 kg	2 22,00 kg
	490527 SLIDE BLACK GRADINO 33x120 Cod. 114 ○		490545 SLIDE BLACK ANGOLARE 33x120 Cod. 110 ○
	490528 SLIDE GREY GRADINO 33x120 Cod. 114 ○		490546 SLIDE GREY ANGOLARE 33x120 Cod. 110 ○
	490529 SLIDE WHITE GRADINO 33x120 Cod. 114 ○		490547 SLIDE WHITE ANGOLARE 33x120 Cod. 110 ○
Gradino		2 15,30 kg	2 16,00 kg
	408119 SLIDE BLACK GRADINO 40x80 Cod. 109 ○		408127 SLIDE BLACK ANGOLARE 40x80 Cod. 113 ○
	408120 SLIDE GREY GRADINO 40x80 Cod. 109 ○		408128 SLIDE GREY ANGOLARE 40x80 Cod. 113 ○
	408121 SLIDE WHITE GRADINO 40x80 Cod. 109 ○		408129 SLIDE WHITE ANGOLARE 40x80 Cod. 113 ○

CARATTERISTICHE DI QUALITÀ Quality characteristics Caractéristiques de qualité Qualitätseigenschaften	NORMA Norm Norme Norme	REQUISITO NORMA Required standards Valeur prescrite selon la norme Normvorgabe	RISULTATO Result Résultat Ergebniss
 Assorbimento d'acqua Water absorption of the body Absorption d'eau de support Wasseraufnahme des Scherbens	ISO 10545-3	≤ 0,5	Conforme Conformity Conforme Gemäss
 Resistenza a flessione Breaking strenght Résistance à la flexion Biegefestigkeit	ISO 10545-4	≥ 35 N/mm ²	Conforme Conformity Conforme Gemäss
 Resistenza all'abrasione Abrasion resistance Resistance à l'abrasion Abriebbeständigkeit	EN ISO 10545-7	WHITE - GREY BLACK	PEI V PEI IV
 Resistenza al gelo Frost resistance Résistance au gel Frostbeständigkeit	ISO 10545-12	Nessun campione deve presentare rotture o alterazioni apprezzabili alla superficie No samples must show ruptures or noticeable surface alteration Aucuns enchantions doit présenter ruptures ou altérations appréciables de la surface Keines der Muster sollte Risse oder sichtbare Fehler der Oberflaeche zeigen	Conforme Conformity Conforme Gemäss
 Resistenza all'attacco chimico Chemical resistance Résistance à l'attaque chimique Beständigkeit gegen chemikalien	ISO 10545-13		GA GLA
 Resistenza agli sbalzi termici Thermal shock resistance Resistance aux écarts de température Temperaturwechselbeständigkeit	ISO 10545-5		Conforme Conformity Conforme Gemäss
 Resistenza scivolosità Sliding resistance Resistance au glissement Rutschfestigkeit	DIN 51130 R	Slide Rettificato Slide Rettificato (20mm) 40x80 - Slide 30x60 R11	R10 R11
 Resistenza scivolosità Sliding resistance Resistance au glissement Rutschfestigkeit	DIN 51097 (A+B+C)	Slide Rettificato Slide Rettificato (20mm) 40x80 - Slide 30x60 R11	A+B A+B+C
 Coefficiente d'attrito dinamico Wet dynamic coefficient of friction Coefficient de friction dynamique Reibungskoeffizient Schlupfrigkeit (in Bewegung)	Bot 3000 E	DCOF ≥ 0,42	> 0,42
 Moderata variazione Moderate variation Variation modérée Mäßige Abweichung			V3

V1 Aspetto uniforme
Uniform appearance
Aspect uniforme
Einheitliches Aussehen

V2 Lieve variazione
Slight variation
Légère variation
Geringe Abweichung

V3 Moderata variazione
Moderate variation
Variation modérée
Mäßige Abweichung

V4 Forte stonizzazione
Substantial variation
Effet dénuancé très accentué
Akzentuierte Variation

PER UNA POSA OTTIMALE DEL PRODOTTO CONSIGLIAMO SEMPRE DI MESCOLARE ALMENO TRE SCATOLE DI MATERIALE.
For the best product laying results, material from at least three boxes should be mixed.
Pour une pose excellente, nous recommandons toujours de mélanger le contenu d'au moins trois boîtes.
Für eine optimale Verlegung des Erzeugnisses empfehlen wir stets, mindestens drei Packungen Material anzumischen.



Tipologia
Type
Typologie
Typ
Gres porcellanato smaltato
Glazed porcelain
Grès cérame emaille
Feinsteinzeug glasiert

Formati
Sizes
Formats
Formate
20x20

Spessore
Thickness
Épaisseur
Stärke
10 mm

Resistenza scivolosità
Sliding resistance
Resistance au glissement
Rutschfestigkeit
R10

Grado di variazione cromatica
Degree of colour change
Degré de variation chromatique
Grad der Farbabweichung
V3



130046
STAGE COZY BLEND RETTIFICATO
20x20
Cod. **81** □



130042
STAGE COZY No.1
RETTIFICATO 20x20
Cod. **81** □

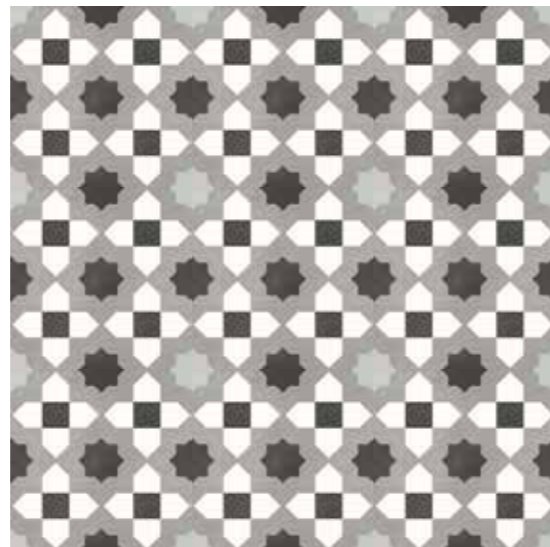

130043
STAGE COZY No.2
RETTIFICATO 20x20
Cod. **81** □



130044
STAGE COZY No.3
RETTIFICATO 20x20
Cod. **81** □



130045
STAGE COZY No.4
RETTIFICATO 20x20
Cod. **81** □



130047
STAGE COZY No.5
RETTIFICATO 20x20
Cod. **81** □



130048
STAGE COZY No.6
RETTIFICATO 20x20
Cod. **81** □

IMBALLI • PACKAGES • EMBALLAGES • FORMATE

SCATOLA • BOX • BOITE • KARTON
PALLET • PALLETS • PALETTS • PALETTE

	<i>pz</i>	<i>mq</i>	<i>kg</i>
20x20	24	0,96	21,50
	<i>box</i>	<i>mq</i>	<i>kg</i>
	54	51,84	1.200,00



130041
STAGE HIPSTER BLEND
RETTIFICATO 20x20
Cod. **81** □



130037
STAGE HIPSTER No.1
RETTIFICATO 20x20
Cod. **81** □



130038
STAGE HIPSTER No.2
RETTIFICATO 20x20
Cod. **81** □



130039
STAGE HIPSTER No.3
RETTIFICATO 20x20
Cod. **81** □



130040
STAGE HIPSTER No.4
RETTIFICATO 20x20
Cod. **81** □



130049
STAGE HIPSTER No.5
RETTIFICATO 20x20
Cod. **81** □

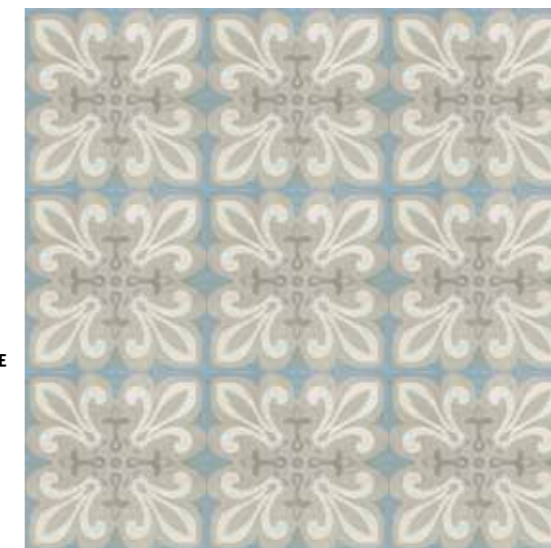

130050
STAGE HIPSTER No.6
RETTIFICATO 20x20
Cod. **81** □

IMBALLI • PACKAGES • EMBALLAGES • FORMATE

SCATOLA • BOX • BOITE • KARTON
PALLET • PALLETS • PALETTS • PALETTE

	<i>pz</i>	<i>mq</i>	<i>kg</i>
20x20	24	0,96	21,50
	<i>box</i>	<i>mq</i>	<i>kg</i>
	54	51,84	1.200,00



130036
STAGE SHABBY CHIC BLEND
RETTIFICATO 20x20
Cod. **81** □



130032
STAGE SHABBY CHIC No.1
RETTIFICATO 20x20
Cod. **81** □



130033
STAGE SHABBY CHIC No.2
RETTIFICATO 20x20
Cod. **81** □

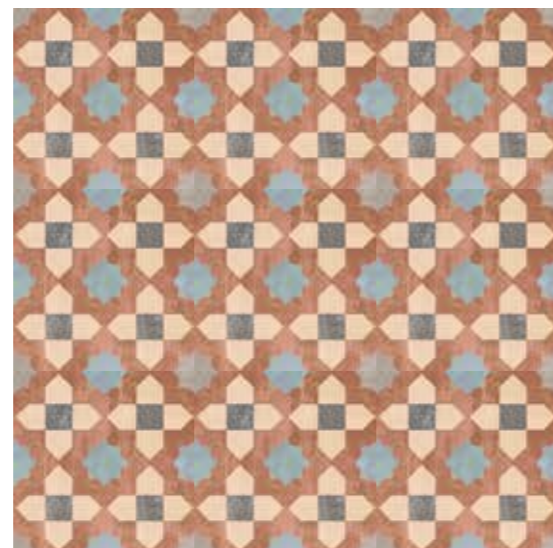

130034
STAGE SHABBY CHIC No.3
RETTIFICATO 20x20
Cod. **81** □

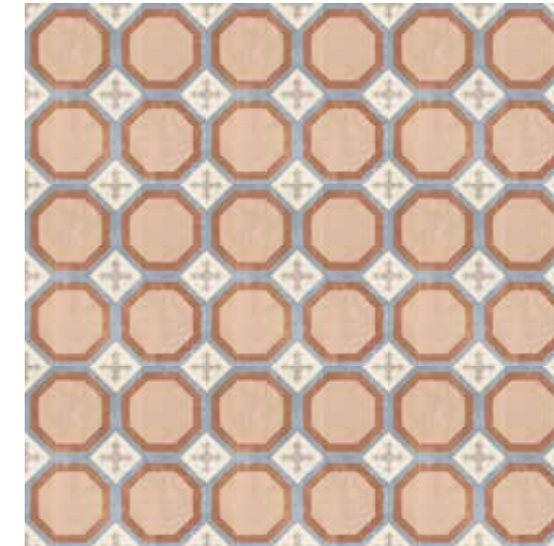

130035
STAGE SHABBY CHIC No.4
RETTIFICATO 20x20
Cod. **81** □

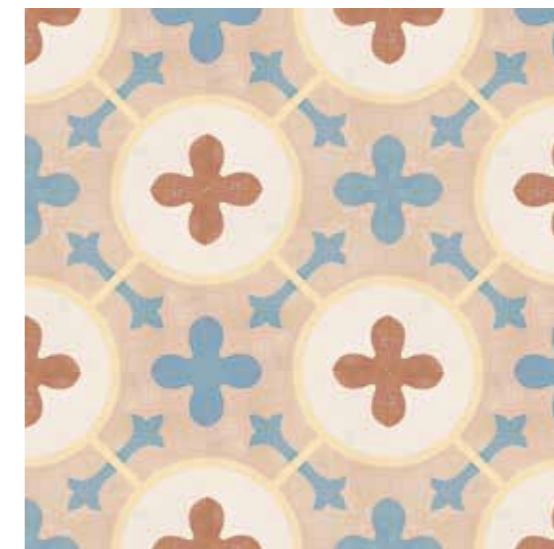

130051
stage SHABBY CHIC No.5
RETTIFICATO 20x20
Cod. **81** □

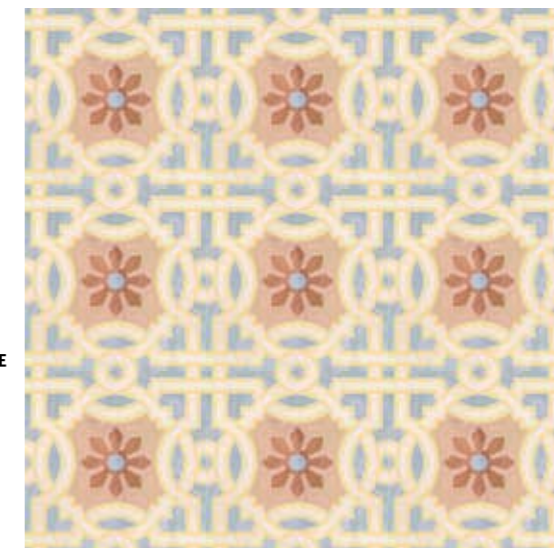

130052
STAGE SHABBY CHIC No.6
RETTIFICATO 20x20
Cod. **81** □

IMBALLI • PACKAGES • EMBALLAGES • FORMATE

SCATOLA • BOX • BOITE • KARTON
PALLET • PALLETS • PALETTS • PALETTE

	<i>pz</i>	<i>mq</i>	<i>kg</i>
20x20	24	0,96	21,50
	<i>box</i>	<i>mq</i>	<i>kg</i>
	54	51,84	1.200,00



CARATTERISTICHE DI QUALITÀ Quality characteristics Caractéristiques de qualité Qualitätseigenschaften	NORMA Norm Norme Norme	REQUISITO NORMA Required standards Valeur prescrite selon la norme Normvorgabe	RISULTATO Result Résultat Ergebniss
Assorbimento d'acqua Water absorption of the body Absorption d'eau de support Wasseraufnahme des Scherbens		≤ 0,5	Conforme Conformity Conforme Gemäss
Resistenza a flessione Breaking strenght Résistance à la flexion Biegefestigkeit	ISO 10545-4	≥ 35 N/mm ²	Conforme Conformity Conforme Gemäss
Resistenza all'abrasione Abrasion resistance Resistance a l'abrasion Abriebbestaendigkeit	ISO 10545-7		PEI IV
Resistenza al gelo Frost resistance Résistance au gel Frostbeständigkeit	ISO 10545-12	Nessun campione deve presentare rotture o alterazioni apprezzabili alla superficie No samples must show ruptures or noticeable surface alteration Aucuns enchantions doit présenter ruptures ou altérations appréciables de la surface Keines der Muster sollte Risse oder sichtbare Fehler der Oberflaeche zeigen	Conforme Conformity Conforme Gemäss
Resistenza all'attacco chimico Chemical resistance Résistance à l'attaque chimique Beständigkeit gegen chemikalien	ISO 10545-13		GA GLA
Resistenza agli sbalzi termici Thermal shock resistance Resistance aux ecart de température Temperaturwechselbeständigkeit	ISO 10545-5		Conforme Conformity Conforme Gemäss
Resistenza scivolosità Sliding resistance Resistance au glissement Rutschfestigkeit	DIN 51130 R		R10
Coefficiente d'attrito dinamico Wet dynamic coefficient of friction Coefficient de friction dynamique Reibungskoeffizient Schlupfrigkeit (in Bewegung)	Bot 3000 E	DCOF ≥ 0,42	> 0,42
Moderata variazione Moderate variation Variation modérée Mäßige Abweichung			V3

V1
Aspetto uniforme
Uniform appearance
Aspect uniforme
Einheitliches Aussehen

V2
Lieve variazione
Slight variation
Légère variation
Geringe Abweichung

V3
Moderata variazione
Moderate variation
Variation modérée
Mäßige Abweichung

V4
Forte stonalizzazione
Substantial variation
Effet dénuancé très accentué
Akzentuierte Variation



Tipologia
Type
Typologie
Typ
Gres porcellanato smaltato
Glazed porcelain
Grès cérame emaille
Feinsteinzeug glasiert

Formati
Sizes
Formats
Formate
120x120
60x120
30x120
60x60
30x60
15x60
30x30
10x30
15x15
7,5x15

Spessore
Thickness
Épaisseur
Stärke
10 mm

Resistenza scivolosità
Sliding resistance
Resistance au glissement
Rutschfestigkeit
R9

Grado di variazione cromatica
Degree of colour change
Degré de variation chromatique
Grad der Farbabweichung
V3



121207
STAT ONE NATURALE RETTIFICATO 120x120
Cod. **100**

121208
STAT ONE LAPPATO RETTIFICATO 120x120
Cod. **141**



601247
STAT ONE NATURALE
RETTIFICATO 60x120
Cod. **94** □

601248
STAT ONE LAPPATO
RETTIFICATO 60x120
Cod. **103** □



301242
STAT ONE NATURALE
RETTIFICATO 30x120
Cod. **99** □

301243
STAT ONE LAPPATO
RETTIFICATO 30x120
Cod. **106** □



550111
STAT ONE NATURALE RETTIFICATO 15x60
Cod. **95** □

550112
STAT ONE LAPPATO RETTIFICATO 15x60
Cod. **111** □

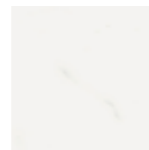

230262
STAT ONE NATURALE
RETTIFICATO 15x15
Cod. **78** □



041044
STAT ONE NATURALE
RETTIFICATO 7,5x15
Cod. **95** □

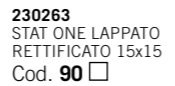

230263
STAT ONE LAPPATO
RETTIFICATO 15x15
Cod. **90** □

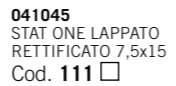

041045
STAT ONE LAPPATO
RETTIFICATO 7,5x15
Cod. **111** □

IMBALLI • PACKAGES • EMBALLAGES • FORMATE

	SCATOLA • BOX • BOITE • KARTON			PALLET • PALLETS • PALETTS • PALETTE		
	pz	mq	kg	box	mq	kg
120x120	2	2,88	68,80	18	51,84	1.260,00
60x120	2	1,44	33,00	30	43,20	1.010,00
30x120	3	1,08	26,50	42	45,36	1.140,00
60x60	3	1,08	24,10	40	43,20	980,00
30x60	6	1,08	24,48	40	43,20	980,00
15x60	10	0,90	19,60	48	43,20	940,00
30x30	11	0,99	23,20	46	45,54	1.070,00
10x30	20	0,60	15,00	60	36,00	920,00
15x15	46	1,04	20,20	33	34,15	665,00
7,5x15	50	0,56	11,30	76	42,56	858,80



606176
STAT ONE NATURALE RETTIFICATO 60x60
Cod. **79** □

606177
STAT ONE LAPPATO RETTIFICATO 60x60
Cod. **93** □

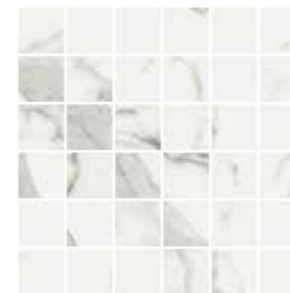

041046
STAT ONE NATURALE
MOSAICO 5x5 SU RETE 30x30
Cod. **24** ○



12,30 kg



041048
STAT ONE NATURALE
MURETTO 2,4x10
SU RETE 30x30
Cod. **46** ○



18,80 kg



041050
STAT ONE NATURALE MOSAICO
ESAGONO SU RETE 27x28
Cod. **136** ○



18,80 kg



041052
STAT ONE NATURALE MOSAICO
INLAY SU RETE 30x30
Cod. **63** ○



18,80 kg

041047
STAT ONE LAPPATO
MOSAICO 5x5 SU RETE 30x30
Cod. **31** ○

041049
STAT ONE LAPPATO
MURETTO 2,4x10
SU RETE 30x30
Cod. **58** ○

041051
STAT ONE LAPPATO MOSAICO
ESAGONO SU RETE 27x28
Cod. **49** ○

041053
STAT ONE LAPPATO MOSAICO
INLAY SU RETE 30x30
Cod. **71** ○



380248
STAT ONE NATURALE
LISTELLO INLAY 5x30
Cod. **10** ○



4,50 kg



380250
STAT ONE NATURALE
LONDON 5x30
Cod. **33** ○



6,43 kg



041179
STAT ONE NATURALE MOSAICO
ARABESQUE SU RETE 30x30
Cod. **57** ○



12,00 kg

380249
STAT ONE LAPPATO
LISTELLO INLAY 5x30
Cod. **11** ○

380251
STAT ONE LUCIDO
LONDON 5x30
Cod. **33** ○

041180
STAT ONE LAPPATO MOSAICO
ARABESQUE SU RETE 30x30
Cod. **72** ○



STAT-ONE RETT. LAPPATO

La finitura lappata è consigliata per uso rivestimento o per pavimenti da bagno in ambito residenziale. Nello specifico il tipo di pavimentazione deve essere non soggetta ad eccessive sollecitazioni e mai a diretto contatto con aree esterne. Come si verifica comunemente nelle pietre naturali l'eventuale presenza di puntini sulla superficie o di qualche disuniformità della lucentezza sono da considerare caratteristiche del prodotto derivanti dalla lavorazione a cui viene sottoposto.









The polished finish is recommended for wall coverings or for the floors of residential bathrooms. Specifically, floor coverings in this material must not be subjected to excessively heavy traffic and must never be in direct contact with outdoor areas. As is often the case with natural stones, any spots on the surface or any unevenness in shine are typical characteristics of the product, deriving from the process used.

La finitura polie est recommandée pour le revêtement sol et mur des salles de bains résidentielles. Notamment, ce type de carreau au sol ne doit pas être exposé à des contraintes excessives, et il ne doit jamais être en contact direct avec des zones extérieures. Comme cela est souvent le cas pour les pierres naturelles, les micro trous éventuellement présents à la surface du produit ou l'hétérogénéité de son éclat forment des caractéristiques propres au façonnage.

Die polierte Oberfläche wird für Wandverkleidungen und Bodenbeläge in Privatbädern empfohlen. Der Bodenbelag darf keinen starken Beanspruchungen ausgesetzt sein und keinen direkten Kontakt zu Außenbereichen haben. Wie bei Natursteinen üblich, kann die Oberfläche Körnungen oder einen unregelmäßigen Glanz aufweisen. Diese Merkmale sind typische, beabsichtigte Produkteigenschaften, die durch das Bearbeitungsverfahren hervorgerufen werden.

Pezzi speciali • Special trims • Pièces spéciales • Formstücke

Battiscopa	 23,60 kg	 23,60 kg	
	290670 STAT ONE BATTISCOPA NATURALE 7x30 Cod. 116 △		290671 STAT ONE BATTISCOPA LAPPATO 7x30 Cod. 22 △

CARATTERISTICHE DI QUALITÀ Quality characteristics Caractéristiques de qualité Qualitätseigenschaften	NORMA Norm Norme Norme	REQUISITO NORMA Required standards Valeur prescrite selon la norme Normvorgabe	RISULTATO Result Résultat Ergebnis
 Assorbimento d'acqua Water absorption of the body Absorption d'eau de support Wasseraufnahme des Scherbens	ISO 10545-3	≤ 0,5	Conforme Conformity Conforme Gemäss
 Resistenza a flessione Breaking strenght Résistance à la flexion Biegefestigkeit	ISO 10545-4	≥ 35 N/mm ²	Conforme Conformity Conforme Gemäss
 Resistenza all'abrasione Abrasion resistance Resistance a l'abrasion Abriebbeständigkeit	EN ISO 10545-7	Stat One Ret.	PEI IV
 Resistenza al gelo Frost resistance Résistance au gel Frostbeständigkeit	ISO 10545-12	Nessun campione deve presentare rotture o alterazioni apprezzabili alla superficie No samples must show ruptures or noticeable surface alteration Aucuns enchantions doit présenter ruptures ou altérations appréciables de la surface Keines der Muster sollte Risse oder sichtbare Fehler der Oberflaeche zeigen	Conforme Conformity Conforme Gemäss
 Resistenza all'attacco chimico Chemical resistance Résistance à l'attaque chimique Beständigkeit gegen chemikalien	ISO 10545-13	Stat One Rettificato Stat One Lappato	GA GLA GA GLB
 Resistenza agli sbalzi termici Thermal shock resistance Resistance aux ecarts de température Temperaturwechselbeständigkeit	ISO 10545-5		Conforme Conformity Conforme Gemäss
 Resistenza scivolosità Sliding resistance Resistance au glissement Rutschfestigkeit	DIN 51130 R	Stat One Rettificato	R9
 Moderata variazione Moderate variation Variation modérée Mäßige Abweichung		Stat One Rettificato	V3

 V1 Aspetto uniforme Uniform appearance Aspect uniforme Einheitliches Aussehen	 V2 Lieve variazione Slight variation Légère variation Geringe Abweichung	 V3 Moderata variazione Moderate variation Variation modérée Mäßige Abweichung	 V4 Forte stonizzazione Substantial variation Effet dénuancé très accentué Akzentuierte Variation
--	---	--	---

PER UNA POSA OTTIMALE DEL PRODOTTO CONSIGLIAMO SEMPRE DI MESCOLARE ALMENO TRE SCATOLE DI MATERIALE.

For the best product laying results, material from at least three boxes should be mixed.

Pour une pose excellente, nous recommandons toujours de mélanger le contenu d'au moins trois boîtes.

Für eine optimale Verlegung des Erzeugnisses empfehlen wir stets, mindestens drei Packungen Material anzumischen.



Tipologia
Type
Typologie
Typ
Gres porcellanato smaltato
Glazed porcelain
Grès cérame emaille
Feinsteinzeug glasiert

Formati R10
Sizes
Formats
Formate
60x120
60x60
30x60
15x60
10x60
7,5x60
5x60
15x17 esagono

Formati R11
Sizes
Formats
Formate
60x60
30x60

Spessore
Thickness
Épaisseur
Stärke
10 mm
20 mm

Resistenza scivolosità
Sliding resistance
Résistance au glissement
Rutschfestigkeit
R10 / A+B
R11 (60x60 - 30x60) / A+B+C

Grado di variazione cromatica
Degree of colour change
Degré de variation chromatique
Grad der Farbabweichung
V2



601285
STONE SELECTION DARK CLOUD RETTIFICATO 60x120
Cod. **94** □



606236
STONE SELECTION DARK CLOUD RETTIFICATO 60x60
Cod. **79** □

606242
STONE SELECTION DARK CLOUD RETTIFICATO **R11** 60x60
Cod. **83** □



490715
STONE SELECTION DARK CLOUD RETTIFICATO 30x60
Cod. **76** □

490719
STONE SELECTION DARK CLOUD RETTIFICATO **R11** 30x60
Cod. **77** □



550121
STONE SELECTION DARK CLOUD RETTIFICATO 15x60
Cod. **82** □



700017
STONE SELECTION DARK CLOUD RETTIFICATO 7,5x60
Cod. **85** □



506006
STONE SELECTION DARK CLOUD RETTIFICATO 5x60
Cod. **90** □



103130
STONE SELECTION DARK CLOUD RETTIFICATO 10x30
Cod. **77** □



230296
STONE SELECTION DARK CLOUD
RETTIFICATO ESAGONO 15x17
Cod. **137** □

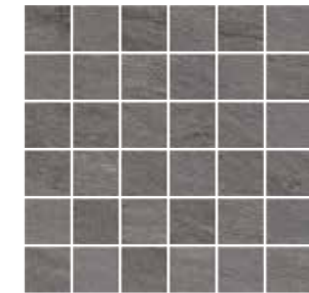

6
10,90 kg

041310
STONE SELECTION DARK CLOUD
MOSAICO 5x5 SU RETE 30x30
Cod. **24** ○



6
10,90 kg

041314
STONE SELECTION DARK CLOUD
MOSAICO FRAME 2,5x7,5
SU RETE 30x30
Cod. **24** ○



6
10,90 kg

041366
STONE SELECTION DARK CLOUD
MOSAICO TEXTURE 2,5x7,5
SU RETE 30x30
Cod. **36** ○

IMBALLI • PACKAGES • EMBALLAGES • FORMATE

	SCATOLA • BOX • BOITE • KARTON			PALLET • PALLETS • PALETTS • PALETTE		
	<i>pz</i>	<i>mq</i>	<i>kg</i>	<i>box</i>	<i>mq</i>	<i>kg</i>
60x120	2	1,44	30,00	32	46,08	985,00
60x60	3	1,08	22,80	40	43,20	935,00
30x60	6	1,08	22,90	40	43,20	940,00
15x60	10	0,90	18,33	48	43,20	905,00
10x60	12	0,72	16,00	60	43,20	985,00
7,5x60	18	0,81	15,20	64	51,84	995,00
5x60	24	0,72	14,50	60	43,20	930,00
15x17 esagono	30	0,57	13,00	56	31,92	748,00



601286
STONE SELECTION DOLMEN WHITE RETTIFICATO 60x120
Cod. **94** □



606237
STONE SELECTION DOLMEN WHITE RETTIFICATO 60x60
Cod. **79** □

606243
STONE SELECTION DOLMEN WHITE RETTIFICATO **R11** 60x60
Cod. **83** □



490716
STONE SELECTION DOLMEN WHITE RETTIFICATO 30x60
Cod. **76** □

490720
STONE SELECTION DOLMEN WHITE RETTIFICATO **R11** 30x60
Cod. **77** □



550122
STONE SELECTION DOLMEN WHITE RETTIFICATO 15x60
Cod. **82** □



700018
STONE SELECTION DOLMEN WHITE RETTIFICATO 7,5x60
Cod. **85** □



506007
STONE SELECTION DOLMEN WHITE RETTIFICATO 5x60
Cod. **90** □



103131
STONE SELECTION DOLMEN WHITE RETTIFICATO 10x30
Cod. **77** □



230297
STONE SELECTION DOLMEN WHITE
RETTIFICATO ESAGONO 15x17
Cod. **137** □



6
10,90 kg

041311
STONE SELECTION DOLMEN WHITE
MOSAICO 5x5 SU RETE 30x30
Cod. **24** ○



6
10,90 kg

041315
STONE SELECTION DOLMEN WHITE
MOSAICO FRAME 2,5x7,5
SU RETE 30x30
Cod. **24** ○



6
10,90 kg

041367
STONE SELECTION DOLMEN WHITE
MOSAICO TEXTURE 2,5x7,5
SU RETE 30x30
Cod. **36** ○

IMBALLI • PACKAGES • EMBALLAGES • FORMATE

	SCATOLA • BOX • BOITE • KARTON			PALLET • PALLETS • PALETTS • PALETTE		
	pz	mq	kg	box	mq	kg
60x120	2	1,44	30,00	32	46,08	985,00
60x60	3	1,08	22,80	40	43,20	935,00
30x60	6	1,08	22,90	40	43,20	940,00
15x60	10	0,90	18,33	48	43,20	905,00
10x60	12	0,72	16,00	60	43,20	985,00
7,5x60	18	0,81	15,20	64	51,84	995,00
5x60	24	0,72	14,50	60	43,20	930,00
15x17 esagono	30	0,57	13,00	56	31,92	748,00



601284
STONE SELECTION NEW GREY RETTIFICATO 60x120
Cod. **94** □



606235
STONE SELECTION NEW GREY RETTIFICATO 60x60
Cod. **79** □

606241
STONE SELECTION NEW GREY RETTIFICATO **R11** 60x60
Cod. **83** □



490714
STONE SELECTION NEW GREY RETTIFICATO 30x60
Cod. **76** □

490718
STONE SELECTION NEW GREY RETTIFICATO **R11** 30x60
Cod. **77** □



550120
STONE SELECTION NEW GREY RETTIFICATO 15x60
Cod. **82** □



700016
STONE SELECTION NEW GREY RETTIFICATO 7,5x60
Cod. **85** □



506005
STONE SELECTION NEW GREY RETTIFICATO 5x60
Cod. **90** □



103129
STONE SELECTION NEW GREY RETTIFICATO 10x30
Cod. **77** □



230295
STONE SELECTION NEW GREY
RETTIFICATO ESAGONO 15x17
Cod. **137** □

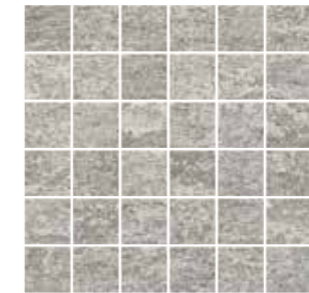

10,90 kg

041309
STONE SELECTION NEW GREY
MOSAICO 5x5 SU RETE 30x30
Cod. **24** ○



10,90 kg

041313
STONE SELECTION NEW GREY
MOSAICO FRAME 2,5x7,5
SU RETE 30x30
Cod. **24** ○



10,90 kg

041365
STONE SELECTION NEW GREY
MOSAICO TEXTURE 2,5x7,5
SU RETE 30x30
Cod. **36** ○

IMBALLI • PACKAGES • EMBALLAGES • FORMATE

	SCATOLA • BOX • BOITE • KARTON			PALLET • PALLETS • PALETTS • PALETTE		
	pz	mq	kg	box	mq	kg
60x120	2	1,44	30,00	32	46,08	985,00
60x60	3	1,08	22,80	40	43,20	935,00
30x60	6	1,08	22,90	40	43,20	940,00
15x60	10	0,90	18,33	48	43,20	905,00
10x60	12	0,72	16,00	60	43,20	985,00
7,5x60	18	0,81	15,20	64	51,84	995,00
5x60	24	0,72	14,50	60	43,20	930,00
15x17 esagono	30	0,57	13,00	56	31,92	748,00



601287
STONE SELECTION MOON CREAM RETTIFICATO 60x120
Cod. **94** □



606238
STONE SELECTION MOON CREAM RETTIFICATO 60x60
Cod. **79** □

606244
STONE SELECTION MOON CREAM RETTIFICATO R11 60x60
Cod. **83** □



490717
STONE SELECTION MOON CREAM RETTIFICATO 30x60
Cod. **76** □

490721
STONE SELECTION MOON CREAM RETTIFICATO R11 30x60
Cod. **77** □



550123
STONE SELECTION MOON CREAM RETTIFICATO 15x60
Cod. **82** □



700019
STONE SELECTION MOON CREAM RETTIFICATO 7,5x60
Cod. **85** □



506008
STONE SELECTION MOON CREAM RETTIFICATO 5x60
Cod. **90** □

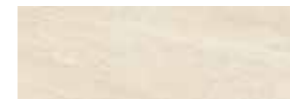

103132
STONE SELECTION MOON CREAM RETTIFICATO 10x30
Cod. **77** □



230298
STONE SELECTION MOON CREAM
RETTIFICATO ESAGONO 15x17
Cod. **137** □

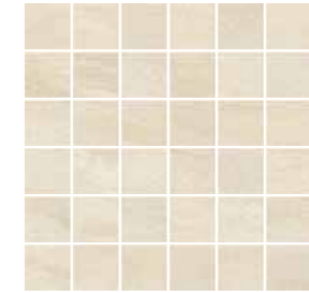

6
10,90 kg

041312
STONE SELECTION MOON CREAM
MOSAICO 5x5 SU RETE 30x30
Cod. **24** ○



6
10,90 kg

041316
STONE SELECTION MOON CREAM
MOSAICO FRAME 2,5x7,5
SU RETE 30x30
Cod. **24** ○



6
10,90 kg

041368
STONE SELECTION MOON CREAM
MOSAICO TEXTURE 2,5x7,5
SU RETE 30x30
Cod. **36** ○

IMBALLI • PACKAGES • EMBALLAGES • FORMATE

	SCATOLA • BOX • BOITE • KARTON			PALLET • PALLETS • PALETTS • PALETTE		
	<i>pz</i>	<i>mq</i>	<i>kg</i>	<i>box</i>	<i>mq</i>	<i>kg</i>
60x120	2	1,44	30,00	32	46,08	985,00
60x60	3	1,08	22,80	40	43,20	935,00
30x60	6	1,08	22,90	40	43,20	940,00
15x60	10	0,90	18,33	48	43,20	905,00
10x60	12	0,72	16,00	60	43,20	985,00
7,5x60	18	0,81	15,20	64	51,84	995,00
5x60	24	0,72	14,50	60	43,20	930,00
15x17 esagono	30	0,57	13,00	56	31,92	748,00



601289
STONE SELECTION DARK CLOUD 2 CM RETTIFICATO 60x120
Cod. 141

20 mm



601290
STONE SELECTION DOLMEN WHITE 2 CM RETTIFICATO 60x120
Cod. 141

20 mm



601288
STONE SELECTION NEW GREY 2 CM RETTIFICATO 60x120
Cod. 141

20 mm



601291
STONE SELECTION MOON CREAM 2 CM RETTIFICATO 60x120
Cod. 141

20 mm

IMBALLI • PACKAGES • EMBALLAGES • FORMATE

	SCATOLA • BOX • BOITE • KARTON			PALLET • PALLETS • PALETTS • PALETTE		
	<i>pz</i>	<i>mq</i>	<i>kg</i>	<i>box</i>	<i>mq</i>	<i>kg</i>

60x120 (20mm)	1	0,72	30,60	36	25,92	1.125,00
----------------------	---	------	-------	----	-------	----------



Pezzi speciali • Special trims • Pièces spéciales • Formstücke

Battiscopa  13,20 kg



290792
STONE SELECTION DARK CLOUD
BATTISCOPA 5x60
Cod. **121** △

290793
STONE SELECTION DOLMEN WHITE
BATTISCOPA 5x60
Cod. **121** △

290791
STONE SELECTION NEW GREY
BATTISCOPA 5x60
Cod. **121** △

290794
STONE SELECTION MOON CREAM
BATTISCOPA 5x60
Cod. **121** △

Gradino  29,40 kg

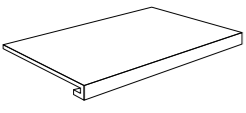

490745
STONE SELECTION DARK CLOUD
GRADINO 33x60
Cod. **112** ○

490746
STONE SELECTION DOLMEN WHITE
GRADINO 33x60
Cod. **112** ○

490744
STONE SELECTION NEW GREY
GRADINO 33x60
Cod. **112** ○

490747
STONE SELECTION MOON CREAM
GRADINO 33x60
Cod. **112** ○

Angolare  10,00 kg

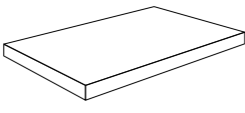



490749
STONE SELECTION DARK CLOUD
ANGOLARE 33x60
Cod. **107** ○

490750
STONE SELECTION DOLMEN WHITE
ANGOLARE 33x60
Cod. **107** ○

490748
STONE SELECTION NEW GREY
ANGOLARE 33x60
Cod. **107** ○

490751
STONE SELECTION MOON CREAM
ANGOLARE 33x60
Cod. **107** ○

 17,28 kg

 20,00 kg

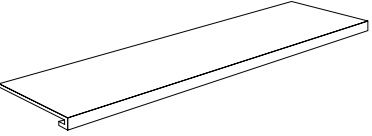

490753
STONE SELECTION DARK CLOUD
GRADINO 33x120
Cod. **114** ○

490754
STONE SELECTION DOLMEN WHITE
GRADINO 33x120
Cod. **114** ○

490752
STONE SELECTION NEW GREY
GRADINO 33x120
Cod. **114** ○

490755
STONE SELECTION MOON CREAM
GRADINO 33x120
Cod. **114** ○

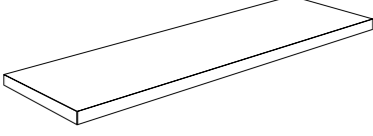











490757
STONE SELECTION DARK CLOUD
ANGOLARE 33x120
Cod. **110** ○

490758
STONE SELECTION DOLMEN WHITE
ANGOLARE 33x120
Cod. **110** ○

490756
STONE SELECTION NEW GREY
ANGOLARE 33x120
Cod. **110** ○

490759
STONE SELECTION MOON CREAM
ANGOLARE 33x120
Cod. **110** ○

CARATTERISTICHE DI QUALITÀ Quality characteristics Caractéristiques de qualité Qualitätseigenschaften	NORMA Norm Norme Norme	REQUISITO NORMA Required standards Valeur prescrite selon la norme Normvorgabe	RISULTATO Result Résultat Ergebniss
 Assorbimento d'acqua Water absorption of the body Absorption d'eau de support Wasseraufnahme des Scherbens	ISO 10545-3	≤ 0,5	Conforme Conformity Conforme Gemäss
 Resistenza a flessione Breaking strenght Résistance à la flexion Biegefestigkeit	ISO 10545-4	≥ 35 N/mm ²	Conforme Conformity Conforme Gemäss
 Resistenza all'abrasione Abrasion resistance Resistance à l'abrasion Abriebbeständigkeit	EN ISO 10545-7		PEI V
 Resistenza al gelo Frost resistance Résistance au gel Frostbeständigkeit	ISO 10545-12	Nessun campione deve presentare rotture o alterazioni apprezzabili alla superficie No samples must show ruptures or noticeable surface alteration Aucuns enchantions doit présenter ruptures ou altérations appréciables de la surface Keines der Muster sollte Risse oder sichtbare Fehler der Oberflaeche zeigen	Conforme Conformity Conforme Gemäss
 Resistenza all'attacco chimico Chemical resistance Résistance à l'attaque chimique Beständigkeit gegen chemikalien	ISO 10545-13		GA GLA
 Resistenza agli sbalzi termici Thermal shock resistance Resistance aux ecart de température Temperaturwechselbeständigkeit	ISO 10545-5		Conforme Conformity Conforme Gemäss
 Resistenza scivolosità Sliding resistance Resistance au glissement Rutschfestigkeit	DIN 51130 R	Versione 10 mm	R10
		60x60cm - 30x60 R11 60x120 20mm	R11 (60x60 - 30x60)
 Resistenza scivolosità Sliding resistance Resistance au glissement Rutschfestigkeit	DIN 51097 (A+B+C)	Versione 10 mm	A+B
		60x60cm - 30x60 R11 60x120 20mm	A+B+C
 Coefficiente d'attrito dinamico Wet dynamic coefficient of friction Coefficient de friction dynamique Reibungskoeffizient Schlupfrigkeit (in Bewegung)	Bot 3000 E	DCOF ≥ 0,42	> 0,42
 Lieve variazione Slight variation Légère variation Geringe Abweichung			V2

V1  Aspetto uniforme
Uniform appearance
Aspect uniforme
Einheitliches Aussehen

V2  Lieve variazione
Slight variation
Légère variation
Geringe Abweichung

V3  Moderata variazione
Moderate variation
Variation modérée
Mäßige Abweichung

V4  Forte stonizzazione
Substantial variation
Effet dénuancé très accentué
Akzentuierte Variation

PER UNA POSA OTTIMALE DEL PRODOTTO CONSIGLIAMO SEMPRE DI MESCOLARE ALMENO TRE SCATOLE DI MATERIALE.
For the best product laying results, material from at least three boxes should be mixed.
Pour une pose excellente, nous recommandons toujours de mélanger le contenu d'au moins trois boîtes.
Für eine optimale Verlegung des Erzeugnisses empfehlen wir stets, mindestens drei Packungen Material anzumischen.



Tipologia
Type
Typologie
Typ
Gres porcellanato smaltato
Glazed porcelain
Grès cérame emaille
Feinsteinzeug glasiert

Formati R10
Sizes
Formats
Formate
60x60
30x60
30x30
10x30
15x15
7,5x15

Spessore
Thickness
Epaisseur
Stärke
8 mm

Resistenza scivolosità
Sliding resistance
Resistance au glissement
Rutschfestigkeit
R10 / A+B

Grado di variazione cromatica
Degree of colour change
Degré de variation chromatique
Grad der Farbabweichung
V4



606110
STREAM CARAMEL RETTIFICATO 60x60
Cod. **77** □



490326
STREAM CARAMEL RETTIFICATO 30x60
Cod. **75** □



230226
STREAM CARAMEL
RETTIFICATO 15x15
Cod. **78** □



103040
STREAM CARAMEL RETTIFICATO 10x30
Cod. **77** □



040802
STREAM CARAMEL RETTIFICATO 30x30
Cod. **78** □



040806
STREAM CARAMEL 7,5x15 SFUSO
Cod. **95** □

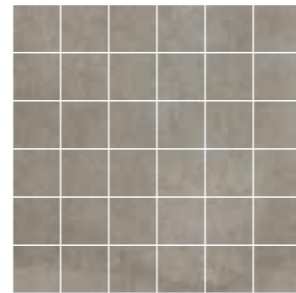

040810
STREAM CARAMEL 5x5
SU RETE 30x30
Cod. **24** ○  10,00 kg

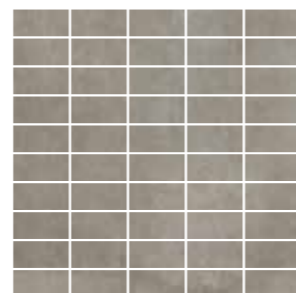

501122
STREAM CARAMEL 2,8x5,8
SU RETE 30x30
Cod. **28** ○  10,00 kg



380158
STREAM CARAMEL
BORDURA 5x30
Cod. **132** ○  5,36 kg
SOLO RIVESTIMENTO - Wall appli-
cation only - Pose mur seulement -
Ausschliesslich Wandbordure



606109
STREAM AVORIO RETTIFICATO 60x60
Cod. **77** □



490325
STREAM AVORIO RETTIFICATO 30x60
Cod. **75** □



230225
STREAM AVORIO
RETTIFICATO 15x15
Cod. **78** □



103039
STREAM AVORIO RETTIFICATO 10x30
Cod. **77** □



040801
STREAM AVORIO RETTIFICATO 30x30
Cod. **78** □



040805
STREAM AVORIO 7,5x15 SFUSO
Cod. **95** □

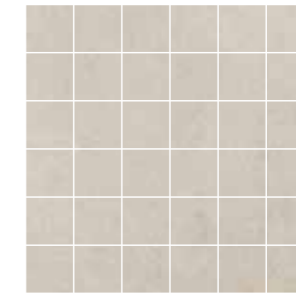

040809
STREAM AVORIO 5x5
SU RETE 30x30
Cod. **24** ○  10,00 kg

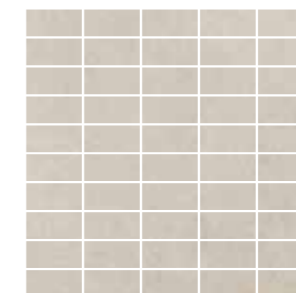

501121
STREAM AVORIO 2,8x5,8
SU RETE 30x30
Cod. **28** ○  10,00 kg



380157
STREAM AVORIO
BORDURA 5x30
Cod. **132** ○  5,36 kg
SOLO RIVESTIMENTO - Wall appli-
cation only - Pose mur seulement -
Ausschliesslich Wandbordure

IMBALLI • PACKAGES • EMBALLAGES • FORMATE

	SCATOLA • BOX • BOITE • KARTON			PALLET • PALLETS • PALETTS • PALETTE		
	pz	mq	kg	box	mq	kg
60x60	4	1,44	24,60	40	57,60	1.010,00
30x60	7	1,26	21,20	40	50,40	870,00
30x30	14	1,26	23,18	40	50,40	950,00
10x30	25	0,75	13,80	60	45,00	850,00
7,5x15	60	0,675	12,40	76	51,30	942,00
15x15	56	1,26	23,20	33	41,58	766,00

IMBALLI • PACKAGES • EMBALLAGES • FORMATE

	SCATOLA • BOX • BOITE • KARTON			PALLET • PALLETS • PALETTS • PALETTE		
	pz	mq	kg	box	mq	kg
60x60	4	1,44	24,60	40	57,60	1.010,00
30x60	7	1,26	21,20	40	50,40	870,00
30x30	14	1,26	23,18	40	50,40	950,00
10x30	25	0,75	13,80	60	45,00	850,00
7,5x15	60	0,675	12,40	76	51,30	942,00
15x15	56	1,26	23,20	33	41,58	766,00

Suggerimenti di posa • Laying proposals • Solutions de pose • Verlegevorschläge

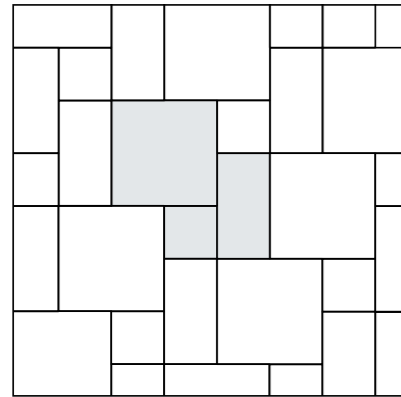

600127
COMPO 1
STREAM AVORIO
Cod. **80** □

600128
COMPO 1
STREAM CAMEL
Cod. **80** □

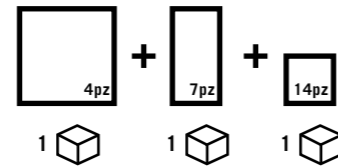

60x60.....57,14%
30x60.....28,57%
30x30.....14,29%

Pezzi speciali • Special trims • Pièces spéciales • Formstücke

Battiscopa



18,30 kg

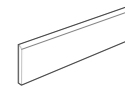

290537
STREAM AVORIO
BATTISCOPA 7x30
Cod. **116** △

290538
STREAM CAMEL
BATTISCOPA 7x30
Cod. **116** △



15,00 kg

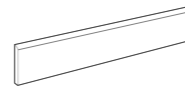

290542
STREAM AVORIO
BATTISCOPA 7x60
Cod. **121** △

290543
STREAM CAMEL
BATTISCOPA 7x60
Cod. **121** △

Gradino



8,00 kg

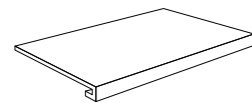

490396
STREAM AVORIO 33x60 GRADINO
Cod. **112** ○

490397
STREAM CAMEL 33x60 GRADINO
Cod. **112** ○

Angolare



8,50 kg

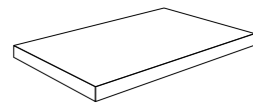

490401
STREAM AVORIO 33x60 ANGOLARE
Cod. **107** ○

490402
STREAM CAMEL 33x60 ANGOLARE
Cod. **107** ○

CARATTERISTICHE DI QUALITÀ Quality characteristics Caractéristiques de qualité Qualitätseigenschaften	NORMA Norm Norme Norme	REQUISITO NORMA Required standards Valeur prescrite selon la norme Normvorgabe	RISULTATO Result Résultat Ergebnis
Assorbimento d'acqua Water absorption of the body Absorption d'eau de support Wasseraufnahme des Scherbens	ISO 10545-3	≤ 0,5	Conforme Conformity Conforme Gemäss
Resistenza a flessione Breaking strenght Résistance à la flexion Biegefestigkeit	ISO 10545-4	≥ 35 N/mm ²	Conforme Conformity Conforme Gemäss
Resistenza all'abrasione Abrasion resistance Resistance à l'abrasion Abriebbeständigkeit	EN ISO 10545-7		PEI IV
Resistenza al gelo Frost resistance Résistance au gel Frostbeständigkeit	ISO 10545-12	Nessun campione deve presentare rotture o alterazioni apprezzabili alla superficie No samples must show ruptures or noticeable surface alteration Aucuns enchantions doit présenter ruptures ou altérations appréciables de la surface Keines der Muster sollte Risse oder sichtbare Fehler der Oberflaeche zeigen	Conforme Conformity Conforme Gemäss
Resistenza all'attacco chimico Chemical resistance Résistance à l'attaque chimique Beständigkeit gegen chemikalien	ISO 10545-13		GA GLA
Resistenza agli sbalzi termici Thermal shock resistance Resistance aux écarts de température Temperaturwechselbeständigkeit	ISO 10545-5		Conforme Conformity Conforme Gemäss
Resistenza scivolosità Sliding resistance Resistance au glissement Rutschfestigkeit	DIN 51130 R		R10
Resistenza scivolosità Sliding resistance Resistance au glissement Rutschfestigkeit	DIN 51097 (A+B+C)		A+B
Coefficiente d'attrito dinamico Wet dynamic coefficient of friction Coefficient de friction dynamique Reibungskoeffizient Schlupfrigkeit (in Bewegung)	Bot 3000 E	DCOF ≥ 0,42	> 0,42
Forte stonalizzazione Substantial variation Effet dénuancé très accentué Akzentuierte Variation			V4

V1
Aspetto uniforme
Uniform appearance
Aspect uniforme
Einheitliches Aussehen

V2
Lieve variazione
Slight variation
Légère variation
Geringe Abweichung

V3
Moderata variazione
Moderate variation
Variation modérée
Mäßige Abweichung

V4
Forte stonalizzazione
Substantial variation
Effet dénuancé très accentué
Akzentuierte Variation

PER UNA POSA OTTIMALE DEL PRODOTTO CONSIGLIAMO SEMPRE DI MESCOLARE ALMENO TRE SCATOLE DI MATERIALE.

For the best product laying results, material from at least three boxes should be mixed.

Pour une pose excellente, nous recommandons toujours de mélanger le contenu d'au moins trois boîtes.

Für eine optimale Verlegung des Erzeugnisses empfehlen wir stets, mindestens drei Packungen Material anzumischen.



Tipologia
Type
Typologie
Typ
Gres porcellanato smaltato
Glazed porcelain
Grès cérame emaille
Feinsteinzeug glasiert

Formati
Sizes
Formats
Formate
60x120
60x60
30x60
30x30
10x30

Spessore
Thickness
Épaisseur
Stärke
10 mm

Resistenza scivolosità
Sliding resistance
Resistance au glissement
Rutschfestigkeit
R9

Grado di variazione cromatica
Degree of colour change
Degré de variation chromatique
Grad der Farbabweichung
V3



601276
STYLISH TAUPE NATURALE
RETTIFICATO 60x120
Cod. **94** □

601277
STYLISH TAUPE LAPPATO
RETTIFICATO 60x120
Cod. **103** □



606221
STYLISH TAUPE NATURALE
RETTIFICATO 60x60
Cod. **79** □

606222
STYLISH TAUPE LAPPATO
RETTIFICATO 60x60
Cod. **93** □



490685
STYLISH TAUPE NATURALE
RETTIFICATO 30x60
Cod. **76** □

490686
STYLISH TAUPE LAPPATO
RETTIFICATO 30x60
Cod. **85** □



041151
STYLISH TAUPE NATURALE RETTIFICATO 30x30
Cod. **78** □

041152
STYLISH TAUPE LAPPATO RETTIFICATO 30x30
Cod. **90** □



103117
STYLISH TAUPE NATURALE
RETTIFICATO 10x30
Cod. **77** □

103118
STYLISH TAUPE LAPPATO
RETTIFICATO 10x30
Cod. **93** □



6
11,40 kg

041236
STYLISH TAUPE NATURALE
MOSAICO 5x5 SU RETE 30x30
Cod. **24** ○

041237
STYLISH TAUPE LAPPATO
MOSAICO 5x5 SU RETE 30x30
Cod. **31** ○



6
10,30 kg

041238
STYLISH TAUPE NATURALE
ESAGONO 27x28
Cod. **136** ○

041239
STYLISH TAUPE LAPPATO
ESAGONO 27x28
Cod. **49** ○



6
13,20 kg

041226
STYLISH TAUPE NATURALE
MOSAICO HB 28x32
Cod. **45** ○

041227
STYLISH TAUPE LAPPATO
MOSAICO HB 28x32
Cod. **48** ○



6
10,30 kg

041220
STYLISH TAUPE NATURALE
ESAGONO INTARSIO 20,7x27
Cod. **57** ○

041221
STYLISH TAUPE LAPPATO
ESAGONO INTARSIO 20,7x27
Cod. **72** ○



10
4,5 kg

380297
STYLISH TAUPE NATURALE
BORDURA MURETTO 7x30
Cod. **28** ○

380298
STYLISH TAUPE LAPPATO
BORDURA MURETTO 7x30
Cod. **28** ○



24
6,44 kg

380291
STYLISH TAUPE NATURALE
LONDON 5x30
Cod. **33** ○

380292
STYLISH TAUPE LUCIDO
LONDON 5x30
Cod. **33** ○

IMBALLI • PACKAGES • EMBALLAGES • FORMATE

	SCATOLA • BOX • BOITE • KARTON			PALLET • PALLETS • PALETTS • PALETTE		
	pz	mq	kg	box	mq	kg
60x120	2	1,44	33,00	30	43,20	1.010,00
60x60	3	1,08	24,10	40	43,20	980,00
30x60	6	1,08	24,48	40	43,20	980,00
30x30	11	0,99	23,20	46	45,54	1.070,00
10x30	20	0,60	15,00	60	36,00	920,00



stylish taupe RETT. LAPPATO

La finitura lappata è consigliata per uso rivestimento o per pavimenti da bagno in ambito residenziale. Nello specifico il tipo di pavimentazione deve essere non soggetta ad eccessive sollecitazioni e mai a diretto contatto con aree esterne. Come si verifica comunemente nelle pietre naturali l'eventuale presenza di puntini sulla superficie o di qualche disuniformità della lucentezza sono da considerare caratteristiche del prodotto derivanti dalla lavorazione a cui viene sottoposto.

The polished finish is recommended for wall coverings or for the floors of residential bathrooms. Specifically, floor coverings in this material must not be subjected to excessively heavy traffic and must never be in direct contact with outdoor areas. As is often the case with natural stones, any spots on the surface or any unevenness in shine are typical characteristics of the product, deriving from the process used.

La finitura polie est recommandée pour le revêtement sol et mur des salles de bains résidentielles. Notamment, ce type de carreau au sol ne doit pas être exposé à des contraintes excessives, et il ne doit jamais être en contact direct avec des zones extérieures. Comme cela est souvent le cas pour les pierres naturelles, les micro trous éventuellement présents à la surface du produit ou l'hétérogénéité de son éclat forment des caractéristiques propres au façonnage.

Die polierte Oberfläche wird für Wandverkleidungen und Bodenbeläge in Privatbädern empfohlen. Der Bodenbelag darf keinen starken Beanspruchungen ausgesetzt sein und keinen direkten Kontakt zu Außenbereichen haben. Wie bei Natursteinen üblich, kann die Oberfläche Körnungen oder einen unregelmäßigen Glanz aufweisen. Diese Merkmale sind typische, beabsichtigte Produkteigenschaften, die durch das Bearbeitungsverfahren hervorgerufen werden.

Pezzi speciali • Special trims • Pièces spéciales • Formstücke

Battiscopa

44
23,60 kg

18
18,00 kg

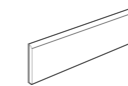

290760
STYLISH TAUPE NATURALE
BATTISCOPIA 7x30
Cod. **116** △

290761
STYLISH TAUPE LAPPATO
BATTISCOPIA 7x30
Cod. **22** △

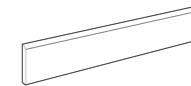

290766
STYLISH TAUPE NATURALE
BATTISCOPIA 7x60
Cod. **121** △

290767
STYLISH TAUPE LAPPATO
BATTISCOPIA 7x60
Cod. **26** △

	CARATTERISTICHE DI QUALITÀ QUALITY CHARACTERISTICS CARACTÉRISTIQUES DE QUALITÉ QUALITÄTSEIGENSCHAFTEN	NORMA NORM NORME NORME	REQUISITO NORMA REQUIRED STANDARDS VALEUR PRESCRITE SELON LA NORME NORMVORGABE	RISULTATO RESULT RÉSULTAT ERGEBNISS
	Assorbimento d'acqua Water absorption of the body Absorption d'eau de support Wasseraufnahme des Scherbens	ISO 10545-3	≤ 0,5	Conforme Conformity Conforme Gemäss
	Resistenza a flessione Breaking strenght Résistance à la flexion Biegefestigkeit	ISO 10545-4	≥ 35 N/mm ²	Conforme Conformity Conforme Gemäss
	Resistenza all'abrasione Abrasion resistance Résistance à l'abrasion Abriebbeständigkeit	ISO 10545-7	Stylish Taupe Rettificato	PEI IV
	Resistenza al gelo Frost resistance Résistance au gel Frostbeständigkeit	ISO 10545-12	Nessun campione deve presentare rotture o alterazioni apprezzabili alla superficie No samples must show ruptures or noticeable surface alteration Aucuns enchantions doit présenter ruptures ou altérations appréciables de la surface Keines der Muster sollte Risse oder sichtbare Fehler der Oberflaeche zeigen	Conforme Conformity Conforme Gemäss
	Resistenza all'attacco chimico Chemical resistance Résistance à l'attaque chimique Beständigkeit gegen chemikalien	ISO 10545-13	Stylish Taupe Naturale Stylish Taupe Lappato	GA GLA GA GLB
	Resistenza agli sbalzi termici Thermal shock resistance Résistance aux écarts de température Temperaturwechselbeständigkeit	ISO 10545-5		Conforme Conformity Conforme Gemäss
	Resistenza scivolosità Sliding resistance Résistance au glissement Rutschfestigkeit	DIN 51130 R		R9
	Moderata variazione Moderate variation Variation modérée Mäßige Abweichung		Stylish Taupe Rettificato	V3

Aspetto uniforme
Uniform appearance
Aspect uniforme
Einheitliches Aussehen
V1

Lieve variazione
Slight variation
Légère variation
Geringe Abweichung
V2

Moderata variazione
Moderate variation
Variation modérée
Mäßige Abweichung
V3

Forte stonalizzazione
Substantial variation
Effet dénuancé très accentué
Akzentuierte Variation
V4

PER UNA POSA OTTIMALE DEL PRODOTTO CONSIGLIAMO SEMPRE DI MESCOLARE ALMENO TRE SCATOLE DI MATERIALE.

For the best product laying results, material from at least three boxes should be mixed.

Pour une pose excellente, nous recommandons toujours de mélanger le contenu d'au moins trois boîtes.

Für eine optimale Verlegung des Erzeugnisses empfehlen wir stets, mindestens drei Packungen Material anzumischen.



Tipologia
Type
Typologie
Typ
Gres porcellanato smaltato
Glazed porcelain
Grès cérame emaille
Feinsteinzeug glasiert

Formati
Sizes
Formats
Formate
60x60
30x60
30x30
10x30
7,5x15

Spessore
Thickness
Epaisseur
Stärke
8 mm

Resistenza scivolosità
Sliding resistance
Resistance au glissement
Rutschfestigkeit
R9

Grado di variazione cromatica
Degree of colour change
Degré de variation chromatique
Grad der Farbabweichung
V4



606100
URBAN STYLE GRIGIO RETTIFICATO 60x60
Cod. 77 □



490295
URBAN STYLE GRIGIO RETTIFICATO 30x60
Cod. 75 □



040768
URBAN STYLE GRIGIO RETTIFICATO 7,5x15
Cod. 95 □



103025
URBAN STYLE GRIGIO
RETTIFICATO 10x30
Cod. 77 □



040764
URBAN STYLE GRIGIO RETTIFICATO 30x30
Cod. 78 □

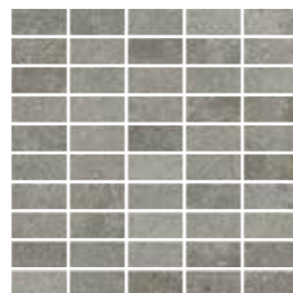

501113
URBAN STYLE GRIGIO FRAME 2,8x5,8
SU RETE 30x30 Cod. 28 ○



040772
URBAN STYLE GRIGIO MOSAICO 5x5
SU RETE 30x30 Cod. 24 ○



380139
URBAN STYLE GRIGIO BORDURA
5x30 Cod. 122 ○



606102
URBAN STYLE SABBIA RETTIFICATO 60x60
Cod. 77 □



490297
URBAN STYLE SABBIA RETTIFICATO 30x60
Cod. 75 □



040770
URBAN STYLE SABBIA RETTIFICATO 7,5x15
Cod. 95 □



103027
URBAN STYLE SABBIA
RETTIFICATO 10x30
Cod. 77 □



040766
URBAN STYLE SABBIA RETTIFICATO 30x30
Cod. 78 □



501114
URBAN STYLE SABBIA FRAME 2,8x5,8
SU RETE 30x30 Cod. 28 ○



040774
URBAN STYLE SABBIA MOSAICO 5x5
SU RETE 30x30 Cod. 24 ○



380141
URBAN STYLE SABBIA BORDURA 5x30
Cod. 122 ○



IMBALLI • PACKAGES • EMBALLAGES • FORMATE

	SCATOLA • BOX • BOITE • KARTON			PALLET • PALLETS • PALETTS • PALETTE		
	pz	mq	kg	box	mq	kg
60x60	4	1,44	26,50	40	57,60	1060,00
30x60	7	1,26	23,20	40	50,40	928,00
30x30	14	1,26	23,20	40	50,40	928,00
10x30	25	0,75	13,80	60	45,00	850,00
7,5x15	60	0,675	12,40	76	51,30	942,00

IMBALLI • PACKAGES • EMBALLAGES • FORMATE





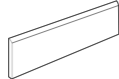

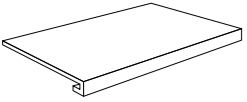
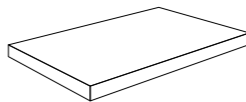

	SCATOLA • BOX • BOITE • KARTON			PALLET • PALLETS • PALETTS • PALETTE		
	pz	mq	kg	box	mq	kg
60x60	4	1,44	26,50	40	57,60	1060,00
30x60	7	1,26	23,20	40	50,40	928,00
30x30	14	1,26	23,20	40	50,40	928,00
10x30	25	0,75	13,80	60	45,00	850,00
7,5x15	60	0,675	12,40	76	51,30	942,00

Pezzi speciali • Special trims • Pièces spéciales • Formstücke

Battiscopa	44 18,30 kg	18 15,00 kg
	290506 URBAN STYLE GRIGIO BATTISCOPIA 7x30 Cod. 116 △	290515 URBAN STYLE GRIGIO BATTISCOPIA 7x60 Cod. 121 △
	290508 URBAN STYLE SABBIA BATTISCOPIA 7x30 Cod. 116 △	290517 URBAN STYLE SABBIA BATTISCOPIA 7x60 Cod. 121 △

Pezzi speciali • Special trims • Pièces spéciales • Formstücke

Gradino	2 8,00 kg	Angolare	2 8,50 kg
	490408 URBAN STYLE GRIGIO GRADINO 33x60 Cod. 112 ○		490412 URBAN STYLE GRIGIO ANGOLARE 33x60 Cod. 107 ○
	490409 URBAN STYLE SABBIA GRADINO 33x60 Cod. 112 ○		490413 URBAN STYLE SABBIA ANGOLARE 33x60 Cod. 107 ○

CARATTERISTICHE DI QUALITÀ Quality characteristics Caractéristiques de qualité Qualitätseigenschaften	NORMA Norm Norme Norme	REQUISITO NORMA Required standards Valeur prescrite selon la norme Normvorgabe	RISULTATO Result Résultat Ergebniss
 Assorbimento d'acqua Water absorption of the body Absorption d'eau de support Wasseraufnahme des Scherbens	ISO 10545-3	≤ 0,5	Conforme Conformity Conforme Gemäss
 Resistenza a flessione Breaking strenght Résistance à la flexion Biegefestigkeit	ISO 10545-4	≥ 35 N/mm ²	Conforme Conformity Conforme Gemäss
 Resistenza all'abrasione Abrasion resistance Resistance a l'abrasion Abriebbeständigkeit	EN ISO 10545-7		PEI IV
 Resistenza al gelo Frost resistance Résistance au gel Frostbeständigkeit	ISO 10545-12	Nessun campione deve presentare rotture o alterazioni apprezzabili alla superficie No samples must show ruptures or noticeable surface alteration Aucuns enchantions doit présenter ruptures ou altérations appréciables de la surface Keines der Muster sollte Risse oder sichtbare Fehler der Oberflaeche zeigen	Conforme Conformity Conforme Gemäss
 Resistenza all'attacco chimico Chemical resistance Résistance à l'attaque chimique Beständigkeit gegen chemikalien	ISO 10545-13		GA GLA
 Resistenza agli sbalzi termici Thermal shock resistance Resistance aux ecarts de température Temperaturwechselbeständigkeit	ISO 10545-5		Conforme Conformity Conforme Gemäss
 Resistenza scivolosità Sliding resistance Resistance au glissement Rutschfestigkeit	DIN 51130 R		R9
 Coefficiente d'attrito dinamico Wet dynamic coefficient of friction Coefficient de friction dynamique Reibungskoeffizient Schlupfgrigkeit (in Bewegung)	Bot 3000 E	DCOF ≥ 0,42	> 0,42
 Forte stonizzazione Substantial variation Effet dénuancé très accentué Akzentuierte Variation			V4

 V1 Aspetto uniforme Uniform appearance Aspect uniforme Einheitliches Aussehen	 V2 Lieve variazione Slight variation Légère variation Geringe Abweichung	 V3 Moderata variazione Moderate variation Variation modérée Mäßige Abweichung	 V4 Forte stonizzazione Substantial variation Effet dénuancé très accentué Akzentuierte Variation
---	--	---	--

PER UNA POSA OTTIMALE DEL PRODOTTO CONSIGLIAMO SEMPRE DI MESCOLARE ALMENO TRE SCATOLE DI MATERIALE.

For the best product laying results, material from at least three boxes should be mixed.

Pour une pose excellente, nous recommandons toujours de mélanger le contenu d'au moins trois boîtes.

Für eine optimale Verlegung des Erzeugnisses empfehlen wir stets, mindestens drei Packungen Material anzumischen.



Tipologia
Type
Typologie
Typ
Gres porcellanato smaltato
Glazed porcelain
Grès cérame emaille
Feinsteinzeug glasiert

Formati
Sizes
Formats
Formate
120x120
60x120
60x60
30x60
30x30
10x30

Spessore
Thickness
Épaisseur
Stärke
10 mm

Resistenza scivolosità
Sliding resistance
Resistance au glissement
Rutschfestigkeit
R9

Grado di variazione cromatica
Degree of colour change
Degré de variation chromatique
Grad der Farbabweichung
V3



121201
VENATO SELECT NATURALE RETTIFICATO 120x120
Cod. **100** □

121202
VENATO SELECT LAPPATO RETTIFICATO 120x120
Cod. **141** □



601262
VENATO SELECT NATURALE
RETTIFICATO 60x120
Cod. **94** □

601263
VENATO SELECT LAPPATO
RETTIFICATO 60x120
Cod. **103** □



606205
VENATO SELECT NATURALE
RETTIFICATO 60x60
Cod. **79** □

606206
VENATO SELECT LAPPATO
RETTIFICATO 60x60
Cod. **93** □



490604
VENATO SELECT NATURALE
RETTIFICATO 30x60
Cod. **76** □

490605
VENATO SELECT LAPPATO
RETTIFICATO 30x60
Cod. **85** □



041142
VENATO SELECT NATURALE RETTIFICATO 30x30
Cod. **78** □

041143
VENATO SELECT LAPPATO RETTIFICATO 30x30
Cod. **90** □



103104
VENATO SELECT NATURALE
RETTIFICATO 10x30
Cod. **77** □

103107
VENATO SELECT LAPPATO
RETTIFICATO 10x30
Cod. **93** □



041144
VENATO SELECT NATURALE
MOSAICO 5x5 SU RETE 30x30
Cod. **24** ○  11,40 kg

041145
VENATO SELECT LAPPATO
MOSAICO 5x5 SU RETE 30x30
Cod. **31** ○

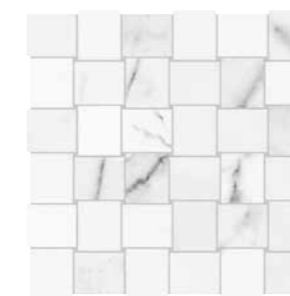

041149
VENATO SELECT NATURALE
MOSAICO INTARSIO 30x30
Cod. **31** ○  10,30 kg

041150
VENATO SELECT LAPPATO
MOSAICO INTARSIO 30x30
Cod. **35** ○



041127
VENATO SELECT NATURALE
MOSAICO HB 28x32
Cod. **45** ○  13,20 kg

041153
VENATO SELECT LAPPATO
MOSAICO HB 28x32
Cod. **48** ○



041146
VENATO SELECT NATURALE
MURETTO 2,4x10
SU RETE 30x30
Cod. **46** ○  10,30 kg

041147
VENATO SELECT LAPPATO
MURETTO 2,4x10
SU RETE 30x30
Cod. **58** ○



041126
VENATO SELECT NATURALE
MOSAICO ESAGONO 27x28
Cod. **136** ○  10,30 kg

041148
VENATO SELECT LAPPATO
MOSAICO ESAGONO 27x28
Cod. **49** ○



041183
VENATO SELECT NATURALE
MOSAICO ARABESQUE
SU RETE 30x30
Cod. **57** ○  12,00 kg

041184
VENATO SELECT LAPPATO
MOSAICO ARABESQUE
SU RETE 30x30
Cod. **72** ○

IMBALLI • PACKAGES • EMBALLAGES • FORMATE

	SCATOLA • BOX • BOITE • KARTON			PALLET • PALLETS • PALETTS • PALETTE		
	pz	mq	kg	box	mq	kg
120x120	2	2,88	68,80	18	51,84	1.260,00
60x120	2	1,44	33,00	30	43,20	1.015,00
60x60	3	1,08	24,00	40	43,20	990,00
30x60	6	1,08	24,00	40	43,20	990,00
30x30	11	0,99	23,00	46	45,54	1.085,00
10x30	20	0,60	15,00	60	36,00	920,00



380270
VENATO SELECT NATURALE
LONDON 5x30
Cod. **33** ○  3,22 kg

380271
VENATO SELECT LUCIDO
LONDON 5x30
Cod. **33** ○



venato select RETT. LAPPATO

La finitura lappata è consigliata per uso rivestimento o per pavimenti da bagno in ambito residenziale. Nello specifico il tipo di pavimentazione deve essere non soggetta ad eccessive sollecitazioni e mai a diretto contatto con aree esterne. Come si verifica comunemente nelle pietre naturali l'eventuale presenza di puntini sulla superficie o di qualche disuniformità della lucentezza sono da considerare caratteristiche del prodotto derivanti dalla lavorazione a cui viene sottoposto.

The polished finish is recommended for wall coverings or for the floors of residential bathrooms. Specifically, floor coverings in this material must not be subjected to excessively heavy traffic and must never be in direct contact with outdoor areas. As is often the case with natural stones, any spots on the surface or any unevenness in shine are typical characteristics of the product, deriving from the process used.

La finitura polie est recommandée pour le revêtement sol et mur des salles de bains résidentielles. Notamment, ce type de carreau au sol ne doit pas être exposé à des contraintes excessives, et il ne doit jamais être en contact direct avec des zones extérieures. Comme cela est souvent le cas pour les pierres naturelles, les micro trous éventuellement présents à la surface du produit ou l'hétérogénéité de son éclat forment des caractéristiques propres au façonnage.

Die polierte Oberfläche wird für Wandverkleidungen und Bodenbeläge in Privatbädern empfohlen. Der Bodenbelag darf keinen starken Beanspruchungen ausgesetzt sein und keinen direkten Kontakt zu Außenbereichen haben. Wie bei Natursteinen üblich, kann die Oberfläche Körnungen oder einen unregelmäßigen Glanz aufweisen. Diese Merkmale sind typische, beabsichtigte Produkteigenschaften, die durch das Bearbeitungsverfahren hervorgerufen werden.

Pezzi speciali • Special trims • Pièces spéciales • Formstücke

Battiscopa



23,60 kg



18,00 kg

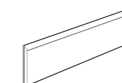

290713
VENATO SELECT NATURALE
BATTISCOPA 7x30
Cod. **116** △

290714
VENATO SELECT LAPPATO
BATTISCOPA 7x30
Cod. **22** △



290741
VENATO SELECT NATURALE
BATTISCOPA 7x60
Cod. **121** △

290742
VENATO SELECT LAPPATO
BATTISCOPA 7x60
Cod. **26** △

CARATTERISTICHE DI QUALITÀ QUALITY CHARACTERISTICS CARACTÉRISTIQUES DE QUALITÉ QUALITÄTSEIGENSCHAFTEN	NORMA NORM NORME NORME	REQUISITO NORMA REQUIRED STANDARDS VALEUR PRESCRITE SELON LA NORME NORMVORGABE	RISULTATO RESULT RÉSULTAT ERGEBNISS
Assorbimento d'acqua Water absorption of the body Absorption d'eau de support Wasseraufnahme des Scherbens	ISO 10545-3	≤ 0,5	Conforme Conformity Conforme Gemäss
Resistenza a flessione Breaking strenght Résistance à la flexion Biegefestigkeit	ISO 10545-4	≥ 35 N/mm ²	Conforme Conformity Conforme Gemäss
Resistenza all'abrasione Abrasion resistance Resistance a l'abrasion Abriebbeständigkeit	ISO 10545-7	Venato Select Rettificato Venato Select Lappato	PEI IV
Resistenza al gelo Frost resistance Résistance au gel Frostbeständigkeit	ISO 10545-12	Nessun campione deve presentare rotture o alterazioni apprezzabili alla superficie No samples must show ruptures or noticeable surface alteration Aucuns enchantions doit présenter ruptures ou altérations appréciables de la surface Keines der Muster sollte Risse oder sichtbare Fehler der Oberfläche zeigen	Conforme Conformity Conforme Gemäss
Resistenza all'attacco chimico Chemical resistance Résistance à l'attaque chimique Beständigkeit gegen chemikalien	ISO 10545-13	Venato Select Rettificato Venato Select Lappato	GA GLA GA GLB
Resistenza agli sbalzi termici Thermal shock resistance Resistance aux écarts de température Temperaturwechselbeständigkeit	ISO 10545-5		Conforme Conformity Conforme Gemäss
Resistenza scivolosità Sliding resistance Resistance au glissement Rutschfestigkeit	DIN 51130 R	Venato Select Rettificato Venato Select Lappato	R9
Moderata variazione Moderate variation Variation modérée Mäßige Abweichung			V3

Aspetto uniforme
Uniform appearance
Aspect uniforme
Einheitliches Aussehen
V1

Lieve variazione
Slight variation
Légère variation
Geringe Abweichung
V2

Moderata variazione
Moderate variation
Variation modérée
Mäßige Abweichung
V3

Forte stonizzazione
Substantial variation
Effet dénuancé très accentué
Akzentuierte Variation
V4

PER UNA POSA OTTIMALE DEL PRODOTTO CONSIGLIAMO SEMPRE DI MESCOLARE ALMENO TRE SCATOLE DI MATERIALE.

For the best product laying results, material from at least three boxes should be mixed.

Pour une pose excellente, nous recommandons toujours de mélanger le contenu d'au moins trois boîtes.

Für eine optimale Verlegung des Erzeugnisses empfehlen wir stets, mindestens drei Packungen Material anzumischen.



Tipologia
Type
Typologie
Typ
Gres porcellanato smaltato
Glazed porcelain
Grès cérame emaille
Feinsteinzeug glasiert

Formati
Sizes
Formats
Formate
60x60
30x60
30x30
15x30
7,5x30
20x20
15x15

Spessore
Thickness
Épaisseur
Stärke
10 mm

Resistenza scivolosità
Sliding resistance
Resistance au glissement
Rutschfestigkeit
R10

Grado di variazione cromatica
Degree of colour change
Degré de variation chromatique
Grad der Farbabweichung
V3



606189
VINTAGE TERRA RETTIFICATO 60x60
Cod. **79** □



490586
VINTAGE TERRA RETTIFICATO 30x60
Cod. **76** □



041073
VINTAGE TERRA RETTIFICATO 30x30
Cod. **78** □



250019
VINTAGE TERRA RETTIFICATO 15x30
Cod. **72** □



606190
VINTAGE TORTORA RETTIFICATO 60x60
Cod. **79** □



490587
VINTAGE TORTORA RETTIFICATO 30x60
Cod. **76** □



041074
VINTAGE TORTORA RETTIFICATO 30x30
Cod. **78** □



250020
VINTAGE TORTORA RETTIFICATO 15x30
Cod. **72** □



041078
VINTAGE TERRA MOSAICO
5x5 SU RETE 30x30
Cod. **24** ○  12,00 kg



501141
VINTAGE TERRA MURETTO
BURATTO 5x5 SU RETE 30x30
Cod. **46** ○  10,69 kg



753006
VINTAGE TERRA RETTIFICATO 7,5x30
Cod. **81** □



130030
VINTAGE TERRA RETTIFICATO 20x20
Cod. **120** □



230273
VINTAGE TERRA RETTIFICATO 15x15
Cod. **78** □



041079
VINTAGE TORTORA MOSAICO
5x5 SU RETE 30x30
Cod. **24** ○  12,00 kg



501142
VINTAGE TORTORA MURETTO
BURATTO 5x5 SU RETE 30x30
Cod. **46** ○  10,69 kg



041084
VINTAGE TORTORA MOSAICO
ESAGONO SU RETE 26x30
Cod. **128** ○  10,69 kg



041094
VINTAGE TORTORA MOSAICO
ARABESQUE SU RETE 20x31
Cod. **38** ○  18,90 kg



753007
VINTAGE TORTORA RETTIFICATO 7,5x30
Cod. **81** □



130031
VINTAGE TORTORA RETTIFICATO 20x20
Cod. **120** □



230274
VINTAGE TORTORA RETTIFICATO 15x15
Cod. **78** □

041083
VINTAGE TERRA MOSAICO
ESAGONO SU RETE 26x30
Cod. **128** ○  10,69 kg

041093
VINTAGE TERRA MOSAICO
ARABESQUE SU RETE 20x31
Cod. **38** ○  18,90 kg

IMBALLI • PACKAGES • EMBALLAGES • FORMATE

	SCATOLA • BOX • BOITE • KARTON			PALLET • PALLETS • PALETTS • PALETTE		
	pz	mq	kg	box	mq	kg
60x60	3	1,08	23,80	40	43,20	970,00
30x60	6	1,08	23,10	40	43,20	950,00
30x30	11	0,99	21,80	46	45,54	1.020,00
15x30	16	0,72	15,48	68	48,96	1.075,00
7,5x30	32	0,72	15,60	84	60,48	1.330,00
20x20	25	1,00	23,00	51	51,00	1.200,00
15x15	46	1,04	20,20	33	34,15	665,00



310204
VINTAGE TERRA
LONDON 5x30
Cod. **33** ○  6,48 kg

IMBALLI • PACKAGES • EMBALLAGES • FORMATE

	SCATOLA • BOX • BOITE • KARTON			PALLET • PALLETS • PALETTS • PALETTE		
	pz	mq	kg	box	mq	kg
60x60	3	1,08	23,80	40	43,20	970,00
30x60	6	1,08	23,10	40	43,20	950,00
30x30	11	0,99	21,80	46	45,54	1.020,00
15x30	16	0,72	15,48	68	48,96	1.075,00
7,5x30	32	0,72	15,60	84	60,48	1.330,00
20x20	25	1,00	23,00	51	51,00	1.200,00
15x15	46	1,04	20,20	33	34,15	665,00



310205
VINTAGE TORTORA
LONDON 5x30
Cod. **33** ○  6,48 kg



606188
VINTAGE COTTO RETTIFICATO 60x60
Cod. **79** □



490584
VINTAGE COTTO RETTIFICATO 30x60
Cod. **76** □



041072
VINTAGE COTTO RETTIFICATO 30x30
Cod. **78** □



250018
VINTAGE COTTO RETTIFICATO 15x30
Cod. **72** □



606192
VINTAGE ECRU RETTIFICATO 60x60
Cod. **79** □



490585
VINTAGE ECRU RETTIFICATO 30x60
Cod. **76** □



041076
VINTAGE ECRU RETTIFICATO 30x30
Cod. **78** □



250022
VINTAGE ECRU RETTIFICATO 15x30
Cod. **72** □



041077
VINTAGE COTTO MOSAICO
5x5 SU RETE 30x30
Cod. **24** ○  12,00 kg

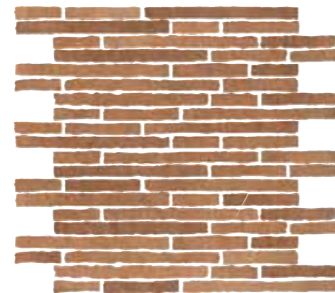

501140
VINTAGE COTTO MURETTO
BURATTO 5x5 SU RETE 30x30
Cod. **46** ○  10,69 kg



753005
VINTAGE COTTO RETTIFICATO 7,5x30
Cod. **81** □



130028
VINTAGE COTTO RETTIFICATO 20x20
Cod. **120** □



230272
VINTAGE COTTO RETTIFICATO 15x15
Cod. **78** □



041081
VINTAGE ECRU MOSAICO
5x5 SU RETE 30x30
Cod. **24** ○  12,00 kg



501144
VINTAGE ECRU MURETTO
BURATTO 5x5 SU RETE 30x30
Cod. **46** ○  10,69 kg



041086
VINTAGE ECRU MOSAICO
ESAGONO SU RETE 26x30
Cod. **128** ○  10,69 kg



041096
VINTAGE ECRU MOSAICO
ARABESQUE SU RETE 20x31
Cod. **38** ○  18,90 kg

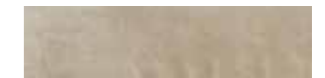

753009
VINTAGE ECRU RETTIFICATO 7,5x30
Cod. **81** □

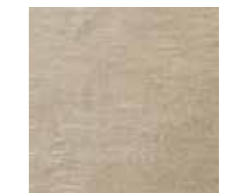

130029
VINTAGE ECRU RETTIFICATO 20x20
Cod. **120** □



230276
VINTAGE ECRU RETTIFICATO 15x15
Cod. **78** □



041082
VINTAGE COTTO MOSAICO
ESAGONO SU RETE 26x30
Cod. **128** ○  10,69 kg



041092
VINTAGE COTTO MOSAICO
ARABESQUE SU RETE 20x31
Cod. **38** ○  18,90 kg

IMBALLI • PACKAGES • EMBALLAGES • FORMATE

	SCATOLA • BOX • BOITE • KARTON			PALLET • PALLETS • PALETTS • PALETTE		
	pz	mq	kg	box	mq	kg
60x60	3	1,08	23,80	40	43,20	970,00
30x60	6	1,08	23,10	40	43,20	950,00
30x30	11	0,99	21,80	46	45,54	1.020,00
15x30	16	0,72	15,48	68	48,96	1.075,00
7,5x30	32	0,72	15,60	84	60,48	1.330,00
20x20	25	1,00	23,00	51	51,00	1.200,00
15x15	46	1,04	20,20	33	34,15	665,00



310203
VINTAGE COTTO
LONDON 5x30
Cod. **33** ○  6,48 kg

IMBALLI • PACKAGES • EMBALLAGES • FORMATE

	SCATOLA • BOX • BOITE • KARTON			PALLET • PALLETS • PALETTS • PALETTE		
	pz	mq	kg	box	mq	kg
60x60	3	1,08	23,80	40	43,20	970,00
30x60	6	1,08	23,10	40	43,20	950,00
30x30	11	0,99	21,80	46	45,54	1.020,00
15x30	16	0,72	15,48	68	48,96	1.075,00
7,5x30	32	0,72	15,60	84	60,48	1.330,00
20x20	25	1,00	23,00	51	51,00	1.200,00
15x15	46	1,04	20,20	33	34,15	665,00



310207
VINTAGE ECRU
LONDON 5x30
Cod. **33** ○  6,48 kg



606191
VINTAGE BLU RETTIFICATO 60x60
Cod. **79** □



490583
VINTAGE BLU RETTIFICATO 30x60
Cod. **76** □



041075
VINTAGE BLU RETTIFICATO 30x30
Cod. **78** □



250021
VINTAGE BLU RETTIFICATO 15x30
Cod. **72** □



041080
VINTAGE BLU MOSAICO
5x5 SU RETE 30x30
Cod. **24** ○



501143
VINTAGE BLU MURETTO
BURATTO 5x5 SU RETE 30x30
Cod. **46** ○



041085
VINTAGE BLU MOSAICO
ESAGONO SU RETE 26x30
Cod. **128** ○



041095
VINTAGE BLU MOSAICO
ARABESQUE SU RETE 20x31
Cod. **38** ○

IMBALLI • PACKAGES • EMBALLAGES • FORMATE

	SCATOLA • BOX • BOITE • KARTON			PALLET • PALLETS • PALETTS • PALETTE		
	pz	mq	kg	box	mq	kg
60x60	3	1,08	23,80	40	43,20	970,00
30x60	6	1,08	23,10	40	43,20	950,00
30x30	11	0,99	21,80	46	45,54	1.020,00
15x30	16	0,72	15,48	68	48,96	1.075,00
7,5x30	32	0,72	15,60	84	60,48	1.330,00
20x20	25	1,00	23,00	51	51,00	1.200,00
15x15	46	1,04	20,20	33	34,15	665,00



753008
VINTAGE BLU RETTIFICATO 7,5x30
Cod. **81** □



130027
VINTAGE BLU RETTIFICATO 20x20
Cod. **120** □



230275
VINTAGE BLU RETTIFICATO 15x15
Cod. **78** □



310206
VINTAGE BLU
LONDON 5x30
Cod. **33** ○

Pezzi speciali • Special trims • Pièces spéciales • Formstücke

Battiscopa



9,00 kg



290688
VINTAGE TERRA BATTISCOPIA
5x30 Cod. **116** △

290689
VINTAGE TORTORA BATTISCOPIA
5x30 Cod. **116** △

290687
VINTAGE COTTO BATTISCOPIA
5x30 Cod. **116** △

290691
VINTAGE ECRÙ BATTISCOPIA
5x30 Cod. **116** △

290690
VINTAGE BLU BATTISCOPIA
5x30 Cod. **116** △



13,32 kg

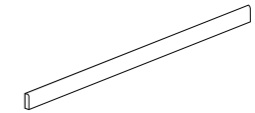

290693
VINTAGE TERRA BATTISCOPIA
5x60 Cod. **121** △

290694
VINTAGE TORTORA BATTISCOPIA
5x60 Cod. **121** △

290692
VINTAGE COTTO BATTISCOPIA
5x60 Cod. **121** △

290696
VINTAGE ECRÙ BATTISCOPIA
5x60 Cod. **121** △

290695
VINTAGE BLU BATTISCOPIA
5x60 Cod. **121** △

Gradino



15,60 kg

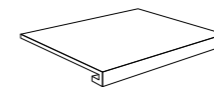

090417
VINTAGE TERRA GRADINO
30x30 Cod. **65** ○

090418
VINTAGE TORTORA GRADINO
30x30 Cod. **65** ○

090415
VINTAGE COTTO GRADINO
30x30 Cod. **65** ○

090416
VINTAGE ECRÙ GRADINO
30x30 Cod. **65** ○

090414
VINTAGE BLU GRADINO
30x30 Cod. **65** ○

Angolare



6,20 kg

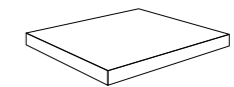

090422
VINTAGE TERRA ANGOLARE
30x30 Cod. **105** ○

090423
VINTAGE TORTORA ANGOLARE
30x30 Cod. **105** ○

090420
VINTAGE COTTO ANGOLARE
30x30 Cod. **105** ○

090421
VINTAGE ECRÙ ANGOLARE
30x30 Cod. **105** ○

090419
VINTAGE BLU ANGOLARE
30x30 Cod. **105** ○

Suggerimenti di posa • Laying proposals • Solutions de pose • Verlegevorschläge

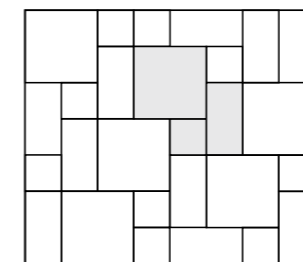

600153
VINTAGE TERRA COMPO 1
60x60+30x60+30x30
Cod. **79** □

600154
VINTAGE TORTORA COMPO 1
60x60+30x60+30x30
Cod. **79** □

600152
VINTAGE COTTO COMPO 1
60x60+30x60+30x30
Cod. **79** □

600156
VINTAGE ECRÙ COMPO 1
60x60+30x60+30x30
Cod. **79** □

600155
VINTAGE BLU COMPO 1
60x60+30x60+30x30
Cod. **79** □

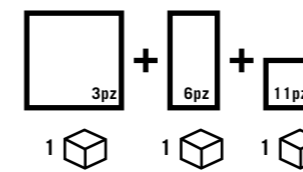

60x60..... 57,14%
30x60..... 28,57%
30x30..... 14,29%

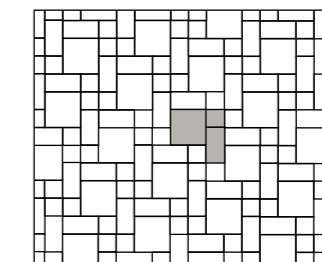

600158
VINTAGE TERRA COMPO 2
30x30+15x30+15x15
Cod. **79** □

600159
VINTAGE TORTORA COMPO 2
30x30+15x30+15x15
Cod. **79** □

600157
VINTAGE COTTO COMPO 2
30x30+15x30+15x15
Cod. **79** □





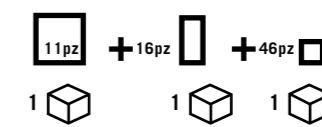



600161
VINTAGE ECRÙ COMPO 2
30x30+15x30+15x15
Cod. **79** □

600160
VINTAGE BLU COMPO 2
30x30+15x30+15x15
Cod. **79** □





30x30..... 57,14%
15x30..... 28,57%
15x15..... 14,29%



CARATTERISTICHE DI QUALITÀ Quality characteristics Caractéristiques de qualité Qualitätseigenschaften	NORMA Norm Norme Norme	REQUISITO NORMA Required standards Valeur prescrite selon la norme Normvorgabe	RISULTATO Result Résultat Ergebnis
 Assorbimento d'acqua Water absorption of the body Absorption d'eau de support Wasseraufnahme des Scherbens	ISO 10545-3	≤ 0,5	Conforme Conformity Conforme Gemäss
 Resistenza a flessione Breaking strenght Résistance à la flexion Biegefestigkeit	ISO 10545-4	≥ 35 N/mm ²	Conforme Conformity Conforme Gemäss
 Resistenza all'abrasione Abrasion resistance Resistance a l'abrasion Abriebbeständigkeit	EN ISO 10545-7		PEI IV
 Resistenza al gelo Frost resistance Résistance au gel Frostbeständigkeit	ISO 10545-12	Nessun campione deve presentare rotture o alterazioni apprezzabili alla superficie No samples must show ruptures or noticeable surface alteration Aucuns enchantions doit présenter ruptures ou altérations appréciables de la surface Keines der Muster sollte Risse oder sichtbare Fehler der Oberflaeche zeigen	Conforme Conformity Conforme Gemäss
 Resistenza all'attacco chimico Chemical resistance Résistance à l'attaque chimique Beständigkeit gegen chemikalien	ISO 10545-13		GA GLA
 Resistenza agli sbalzi termici Thermal shock resistance Resistance aux ecarts de température Temperaturwechselbeständigkeit	ISO 10545-5		Conforme Conformity Conforme Gemäss
 Resistenza scivolosità Sliding resistance Resistance au glissement Rutschfestigkeit	DIN 51130 R		R10
 Coefficiente d'attrito dinamico Wet dynamic coefficient of friction Coefficient de friction dynamique Reibungskoeffizient Schlupfrigkeit (in Bewegung)	Bot 3000 E	DCOF ≥ 0,42	> 0,42
 Moderata variazione Moderate variation Variation modérée Mäßige Abweichung			V3

 V1
Aspetto uniforme
Uniform appearance
Aspect uniforme
Einheitliches Aussehen

 V2
Lieve variazione
Slight variation
Légère variation
Geringe Abweichung

 V3
Moderata variazione
Moderate variation
Variation modérée
Mäßige Abweichung

 V4
Forte stonizzazione
Substantial variation
Effet dénuancé très accentué
Akzentuierte Variation

PER UNA POSA OTTIMALE DEL PRODOTTO CONSIGLIAMO SEMPRE DI MESCOLARE ALMENO TRE SCATOLE DI MATERIALE.

For the best product laying results, material from at least three boxes should be mixed.

Pour une pose excellente, nous recommandons toujours de mélanger le contenu d'au moins trois boîtes.

Für eine optimale Verlegung des Erzeugnisses empfehlen wir stets, mindestens drei Packungen Material anzumischen.



Tipologia
Type
Typologie
Typ
Gres porcellanato smaltato
Glazed porcelain
Grès cérame emaille
Feinsteinzeug glasiert

Formati
Sizes
Formats
Formate
120x120
60x120
30x120
60x60
30x60
15x60
30x30
10x30
15x15

Spessore
Thickness
Épaisseur
Stärke
10 mm

Resistenza scivolosità
Sliding resistance
Resistance au glissement
Rutschfestigkeit
R9

Grado di variazione cromatica
Degree of colour change
Degré de variation chromatique
Grad der Farbabweichung
V2



121203
WHITE DOLOMITE NATURALE RETTIFICATO 120x120
Cod. **100** □

121204
WHITE DOLOMITE LAPPATO RETTIFICATO 120x120
Cod. **141** □

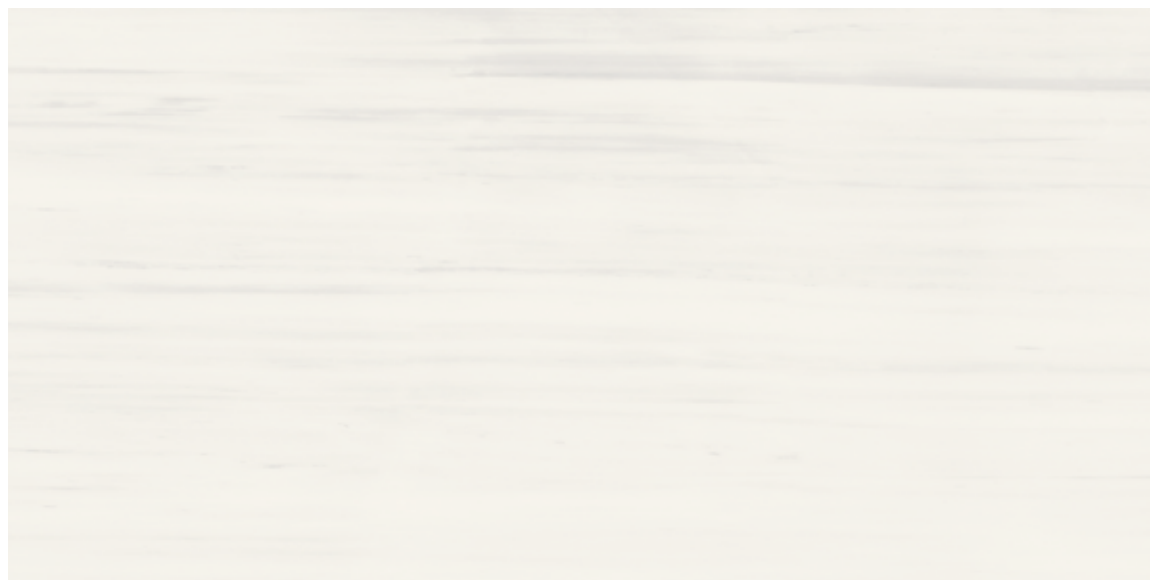

601245
WHITE DOLOMITE NATURALE
RETTIFICATO 60x120
Cod. **94** □

601246
WHITE DOLOMITE LAPPATO
RETTIFICATO 60x120
Cod. **103** □

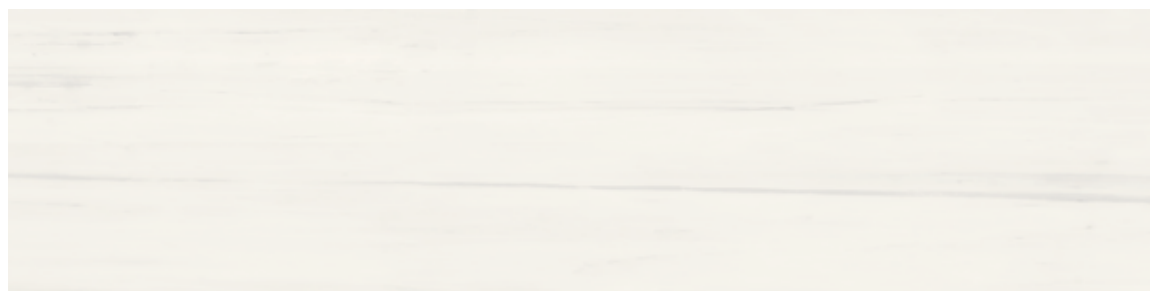

301240
WHITE DOLOMITE NATURALE
RETTIFICATO 30x120
Cod. **99** □

301241
WHITE DOLOMITE LAPPATO
RETTIFICATO 30x120
Cod. **106** □



550109
WHITE DOLOMITE NATURALE
RETTIFICATO 15x60
Cod. **95** □

550110
WHITE DOLOMITE LAPPATO
RETTIFICATO 15x60
Cod. **111** □



230260
WHITE DOLOMITE NATURALE
RETTIFICATO 15x15
Cod. **78** □

230261
WHITE DOLOMITE LAPPATO
RETTIFICATO 15x15
Cod. **90** □

IMBALLI • PACKAGES • EMBALLAGES • FORMATE

	SCATOLA • BOX • BOITE • KARTON			PALLET • PALLETS • PALETTS • PALETTE		
	pz	mq	kg	box	mq	kg
120x120	2	2,88	68,80	18	51,84	1.260,00
60x120	2	1,44	33,00	30	43,20	1.010,00
30x120	3	1,08	26,50	42	45,36	1.140,00
60x60	3	1,08	24,10	40	43,20	980,00
30x60	6	1,08	24,48	40	43,20	980,00
15x60	10	0,90	19,60	48	43,20	940,00
30x30	11	0,99	23,20	46	45,54	1.070,00
10x30	20	0,60	15,00	60	36,00	920,00
15x15	46	1,04	20,20	33	34,15	665,00

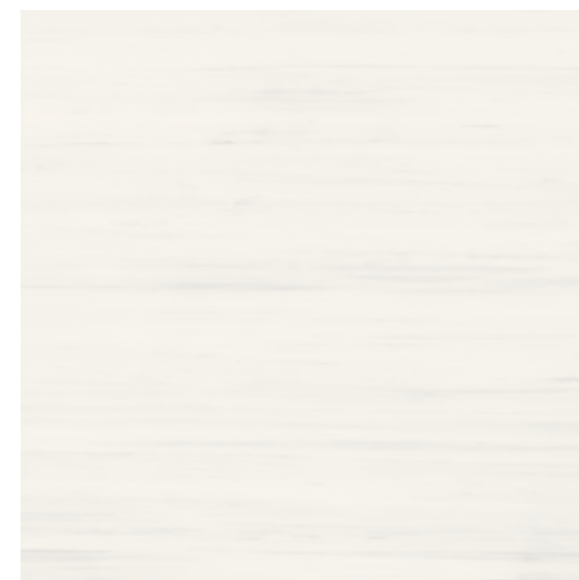

606174
WHITE DOLOMITE NATURALE RETTIFICATO 60x60
Cod. **79** □

606175
WHITE DOLOMITE LAPPATO RETTIFICATO 60x60
Cod. **93** □



490567
WHITE DOLOMITE NATURALE
RETTIFICATO 30x60
Cod. **76** □

490568
WHITE DOLOMITE LAPPATO
RETTIFICATO 30x60
Cod. **85** □



041030
WHITE DOLOMITE NATURALE RETTIFICATO 30x30
Cod. **78** □

041031
WHITE DOLOMITE LAPPATO RETTIFICATO 30x30
Cod. **90** □

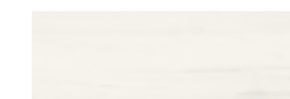

103088
WHITE DOLOMITE NATURALE
RETTIFICATO 10x30
Cod. **77** □

103089
WHITE DOLOMITE LAPPATO
RETTIFICATO 10x30
Cod. **93** □

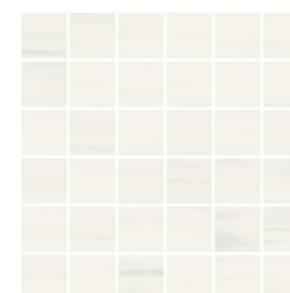

041034
WHITE DOLOMITE NATURALE
5x5 MOSAICO SU RETE 30x30
Cod. **24** □



041038
WHITE DOLOMITE NATURALE
MOSAICO ESAGONO
SU RETE 27x28
Cod. **136** ○



041036
WHITE DOLOMITE NATURALE
MURETTO 2,4x10
SU RETE 30x30
Cod. **46** ○

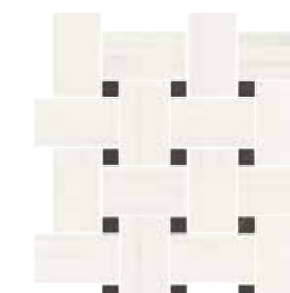

041040
WHITE DOLOMITE NATURALE
MOSAICO BASKETWAVE 30x30
Cod. **47** ○

041035
WHITE DOLOMITE LAPPATO
5x5 MOSAICO SU RETE 30x30
Cod. **31** ○

041039
WHITE DOLOMITE LAPPATO
MOSAICO ESAGONO SU RETE 27x28
Cod. **49** ○

041037
WHITE DOLOMITE LAPPATO
MURETTO 2,4x10
SU RETE 30x30
Cod. **58** ○

041041
WHITE DOLOMITE LAPPATO
MOSAICO BASKETWAVE 30x30
Cod. **60** ○



041058
WHITE DOLOMITE NATURALE
MOSAICO ESAGONO BLEND
SU RETE 21,5x18,6
Cod. **25** ○



5,70 kg



041016
WHITE DOLOMITE NATURALE
BORDURA MURETTO
SU RETE 7,3x30
Cod. **28** ○



4,50 kg



380244
WHITE DOLOMITE NATURALE
LONDON 5x30
Cod. **33** ○



6,43 kg

041059
WHITE DOLOMITE LAPPATO
MOSAICO ESAGONO BLEND
SU RETE 21,5x18,6
Cod. **34** ○

380247
WHITE DOLOMITE LAPPATO
BORDURA MURETTO
SU RETE 7,3x30
Cod. **28** ○

380245
WHITE DOLOMITE LUCIDO
LONDON 5x30
Cod. **33** ○



white dolomite RETT. LAPPATO

La finitura lappata è consigliata per uso rivestimento o per pavimenti da bagno in ambito residenziale. Nello specifico il tipo di pavimentazione deve essere non soggetta ad eccessive sollecitazioni e mai a diretto contatto con aree esterne. Come si verifica comunemente nelle pietre naturali l'eventuale presenza di puntini sulla superficie o di qualche disuniformità della lucentezza sono da considerare caratteristiche del prodotto derivanti dalla lavorazione a cui viene sottoposto.









The polished finish is recommended for wall coverings or for the floors of residential bathrooms. Specifically, floor coverings in this material must not be subjected to excessively heavy traffic and must never be in direct contact with outdoor areas. As is often the case with natural stones, any spots on the surface or any unevenness in shine are typical characteristics of the product, deriving from the process used.



La finitura polie est recommandée pour le revêtement sol et mur des salles de bains résidentielles. Notamment, ce type de carreau au sol ne doit pas être exposé à des contraintes excessives, et il ne doit jamais être en contact direct avec des zones extérieures. Comme cela est souvent le cas pour les pierres naturelles, les micro trous éventuellement présents à la surface du produit ou l'hétérogénéité de son éclat forment des caractéristiques propres au façonnage.

Die polierte Oberfläche wird für Wandverkleidungen und Bodenbeläge in Privatbädern empfohlen. Der Bodenbelag darf keinen starken Beanspruchungen ausgesetzt sein und keinen direkten Kontakt zu Außenbereichen haben. Wie bei Natursteinen üblich, kann die Oberfläche Körnungen oder einen unregelmäßigen Glanz aufweisen. Diese Merkmale sind typische, beabsichtigte Produkteigenschaften, die durch das Bearbeitungsverfahren hervorgerufen werden.

Pezzi speciali • Special trims • Pièces spéciales • Formstücke

Battiscopa	 23,60 kg	 23,60 kg	
	290668 WHITE DOLOMITE NATURALE BATTISCOPA 7x30 Cod. 116 △		290669 WHITE DOLOMITE LAPPATO BATTISCOPA 7x30 Cod. 22 △

CARATTERISTICHE DI QUALITÀ Quality characteristics Caractéristiques de qualité Qualitätseigenschaften	NORMA Norm Norme Norme	REQUISITO NORMA Required standards Valeur prescrite selon la norme Normvorgabe	RISULTATO Result Résultat Ergebnis
 Assorbimento d'acqua Water absorption of the body Absorption d'eau de support Wasseraufnahme des Scherbens	ISO 10545-3	≤ 0,5	Conforme Conformity Conforme Gemäss
 Resistenza a flessione Breaking strenght Résistance à la flexion Biegefestigkeit	ISO 10545-4	≥ 35 N/mm ²	Conforme Conformity Conforme Gemäss
 Resistenza all'abrasione Abrasion resistance Resistance a l'abrasion Abriebbeständigkeit	EN ISO 10545-7 EN ISO 10545-6	White Dolomite Rettificato White Dolomite Lappato	PEI IV
 Resistenza al gelo Frost resistance Résistance au gel Frostbeständigkeit	ISO 10545-12	Nessun campione deve presentare rotture o alterazioni apprezzabili alla superficie No samples must show ruptures or noticeable surface alteration Aucuns enchantions doit présenter ruptures ou altérations appréciables de la surface Keines der Muster sollte Risse oder sichtbare Fehler der Oberflaeche zeigen	Conforme Conformity Conforme Gemäss
 Resistenza all'attacco chimico Chemical resistance Résistance à l'attaque chimique Beständigkeit gegen chemikalien	ISO 10545-13	White Dolomite Rettificato White Dolomite Lappato	GA GLA GA GLB
 Resistenza agli sbalzi termici Thermal shock resistance Resistance aux écarts de température Temperaturwechselbeständigkeit	ISO 10545-5		Conforme Conformity Conforme Gemäss
 Resistenza scivolosità Sliding resistance Résistance au glissement Rutschfestigkeit	DIN 51130 R	White Dolomite Rettificato White Dolomite Lappato	R9
 Lieve variazione Slight variation Légère variation Geringe Abweichung			V2

 V1 Aspetto uniforme Uniform appearance Aspect uniforme Einheitliches Aussehen	 V2 Lieve variazione Slight variation Légère variation Geringe Abweichung	 V3 Moderata variazione Moderate variation Variation modérée Mäßige Abweichung	 V4 Forte stonizzazione Substantial variation Effet dénuancé très accentué Akzentuierte Variation
--	---	--	---

PER UNA POSA OTTIMALE DEL PRODOTTO CONSIGLIAMO SEMPRE DI MESCOLARE ALMENO TRE SCATOLE DI MATERIALE.

For the best product laying results, material from at least three boxes should be mixed.

Pour une pose excellente, nous recommandons toujours de mélanger le contenu d'au moins trois boîtes.

Für eine optimale Verlegung des Erzeugnisses empfehlen wir stets, mindestens drei Packungen Material anzumischen.



Tipologia
Type
Typologie
Typ
Gres porcellanato smaltato
Glazed porcelain
Grès cérame emaille
Feinsteinzeug glasiert

Formati
Sizes
Formats
Formate
60x120
60x60
30x60
30x30
10x30

Spessore
Thickness
Epaisseur
Stärke
10 mm

Resistenza scivolosità
Sliding resistance
Resistance au glissement
Rutschfestigkeit
R9

Grado di variazione cromatica
Degree of colour change
Degré de variation chromatique
Grad der Farbabweichung
V3



601274
WHITE ONYX NATURALE
RETTIFICATO 60x120
Cod. **94** □

601275
WHITE ONYX LAPPATO
RETTIFICATO 60x120
Cod. **103** □



606219
WHITE ONYX NATURALE
RETTIFICATO 60x60
Cod. **79** □

606220
WHITE ONYX LAPPATO
RETTIFICATO 60x60
Cod. **93** □



490681
WHITE ONYX NATURALE
RETTIFICATO 30x60
Cod. **76** □

490682
WHITE ONYX LAPPATO
RETTIFICATO 30x60
Cod. **85** □



041204
WHITE ONYX NATURALE RETTIFICATO 30x30
Cod. **78** □

041205
WHITE ONYX LAPPATO RETTIFICATO 30x30
Cod. **90** □



103113
WHITE ONYX NATURALE
RETTIFICATO 10x30
Cod. **77** □

103114
WHITE ONYX LAPPATO
RETTIFICATO 10x30
Cod. **93** □



11,40 kg

041206
WHITE ONYX NATURALE
MOSAICO 5x5 SU RETE 30x30
Cod. **24** ○

041207
WHITE ONYX LAPPATO
MOSAICO 5x5 SU RETE 30x30
Cod. **31** ○



10,30 kg

041212
WHITE ONYX NATURALE
ESAGONO 27x28
Cod. **136** ○

041213
WHITE ONYX LAPPATO
ESAGONO 27x28
Cod. **49** ○



13,20 kg

041218
WHITE ONYX NATURALE
MOSAICO HB 28x32
Cod. **45** ○

041219
WHITE ONYX LAPPATO
MOSAICO HB 28x32
Cod. **48** ○



10,30 kg

041214
WHITE ONYX NATURALE
ESAGONO INTARSIO 20,7x27
Cod. **57** ○

041215
WHITE ONYX LAPPATO
ESAGONO INTARSIO 20,7x27
Cod. **72** ○



4,5 kg

380287
WHITE ONYX NATURALE
BORDURA MURETTO 7x30
Cod. **28** ○

380288
WHITE ONYX LAPPATO
BORDURA MURETTO 7x30
Cod. **28** ○



6,44 kg

380285
WHITE ONYX NATURALE
LONDON 5x30
Cod. **33** ○

380286
WHITE ONYX LUCIDO
LONDON 5x30
Cod. **33** ○

IMBALLI • PACKAGES • EMBALLAGES • FORMATE

	SCATOLA • BOX • BOITE • KARTON			PALLET • PALLETS • PALETTS • PALETTE		
	pz	mq	kg	box	mq	kg
60x120	2	1,44	33,00	30	43,20	1.010,00
60x60	3	1,08	24,10	40	43,20	980,00
30x60	6	1,08	24,48	40	43,20	980,00
30x30	11	0,99	23,20	46	45,54	1.070,00
10x30	20	0,60	15,00	60	36,00	920,00



white onyx RETT. LAPPATO

La finitura lappata è consigliata per uso rivestimento o per pavimenti da bagno in ambito residenziale. Nello specifico il tipo di pavimentazione deve essere non soggetta ad eccessive sollecitazioni e mai a diretto contatto con aree esterne. Come si verifica comunemente nelle pietre naturali l'eventuale presenza di puntini sulla superficie o di qualche disuniformità della lucentezza sono da considerare caratteristiche del prodotto derivanti dalla lavorazione a cui viene sottoposto.

The polished finish is recommended for wall coverings or for the floors of residential bathrooms. Specifically, floor coverings in this material must not be subjected to excessively heavy traffic and must never be in direct contact with outdoor areas. As is often the case with natural stones, any spots on the surface or any unevenness in shine are typical characteristics of the product, deriving from the process used.

La finitura polie est recommandée pour le revêtement sol et mur des salles de bains résidentielles. Notamment, ce type de carreau au sol ne doit pas être exposé à des contraintes excessives, et il ne doit jamais être en contact direct avec des zones extérieures. Comme cela est souvent le cas pour les pierres naturelles, les micro trous éventuellement présents à la surface du produit ou l'hétérogénéité de son éclat forment des caractéristiques propres au façonnage.

Die polierte Oberfläche wird für Wandverkleidungen und Bodenbeläge in Privatbädern empfohlen. Der Bodenbelag darf keinen starken Beanspruchungen ausgesetzt sein und keinen direkten Kontakt zu Außenbereichen haben. Wie bei Natursteinen üblich, kann die Oberfläche Körnungen oder einen unregelmäßigen Glanz aufweisen. Diese Merkmale sind typische, beabsichtigte Produkteigenschaften, die durch das Bearbeitungsverfahren hervorgerufen werden.

Pezzi speciali • Special trims • Pièces spéciales • Formstücke

Battiscopa

44
23,60 kg

18
18,00 kg

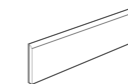

290754
WHITE ONYX NATURALE
BATTISCOPIA 7x30
Cod. **116** △

290755
WHITE ONYX LAPPATO
BATTISCOPIA 7x30
Cod. **22** △

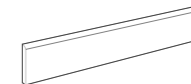

290756
WHITE ONYX NATURALE
BATTISCOPIA 7x60
Cod. **121** △

290757
WHITE ONYX LAPPATO
BATTISCOPIA 7x60
Cod. **26** △

CARATTERISTICHE DI QUALITÀ QUALITY CHARACTERISTICS CARACTÉRISTIQUES DE QUALITÉ QUALITÄTSEIGENSCHAFTEN	NORMA NORM NORME NORME	REQUISITO NORMA REQUIRED STANDARDS VALEUR PRESCRITE SELON LA NORME NORMVORGABE	RISULTATO RESULT RÉSULTAT ERGEBNISS
Assorbimento d'acqua Water absorption of the body Absorption d'eau de support Wasseraufnahme des Scherbens	ISO 10545-3	≤ 0,5	Conforme Conformity Conforme Gemäss
Resistenza a flessione Breaking strenght Résistance à la flexion Biegefestigkeit	ISO 10545-4	≥ 35 N/mm ²	Conforme Conformity Conforme Gemäss
Resistenza all'abrasione Abrasion resistance Résistance à l'abrasion Abriebbeständigkeit	ISO 10545-7	White Onyx Rettificato	PEI IV
Resistenza al gelo Frost resistance Résistance au gel Frostbeständigkeit	ISO 10545-12	Nessun campione deve presentare rotture o alterazioni apprezzabili alla superficie No samples must show ruptures or noticeable surface alteration Aucuns enchantions doit présenter ruptures ou altérations appréciables de la surface Keines der Muster sollte Risse oder sichtbare Fehler der Oberflaeche zeigen	Conforme Conformity Conforme Gemäss
Resistenza all'attacco chimico Chemical resistance Résistance à l'attaque chimique Beständigkeit gegen chemikalien	ISO 10545-13	White Onyx Naturale White Onyx Lappato	GA GLA GA GLB
Resistenza agli sbalzi termici Thermal shock resistance Résistance aux écarts de température Temperaturwechselbeständigkeit	ISO 10545-5		Conforme Conformity Conforme Gemäss
Resistenza scivolosità Sliding resistance Résistance au glissement Rutschfestigkeit	DIN 51130 R		R9
Moderata variazione Moderate variation Variation modérée Mäßige Abweichung		White Onyx Rettificato	V3

Aspetto uniforme
Uniform appearance
Aspect uniforme
Einheitliches Aussehen
V1

Lieve variazione
Slight variation
Légère variation
Geringe Abweichung
V2

Moderata variazione
Moderate variation
Variation modérée
Mäßige Abweichung
V3

Forte stonalizzazione
Substantial variation
Effet dénuancé très accentué
Akzentuierte Variation
V4

PER UNA POSA OTTIMALE DEL PRODOTTO CONSIGLIAMO SEMPRE DI MESCOLARE ALMENO TRE SCATOLE DI MATERIALE.

For the best product laying results, material from at least three boxes should be mixed.

Pour une pose excellente, nous recommandons toujours de mélanger le contenu d'au moins trois boîtes.

Für eine optimale Verlegung des Erzeugnisses empfehlen wir stets, mindestens drei Packungen Material anzumischen.



Tipologia
Type
Typologie
Typ
Gres porcellanato smaltato
Glazed porcelain
Grès cérame emaille
Feinsteinzeug glasiert

Formati R9
Sizes
Formats
Formate
30x120
20x120

Formati R10
Sizes
Formats
Formate
30x120
20x120

Spessore
Thickness
Épaisseur
Stärke
10 mm

Resistenza scivolosità
Sliding resistance
Resistance au glissement
Rutschfestigkeit
R9-R10 / A+B

Grado di variazione cromatica
Degree of colour change
Degré de variation chromatique
Grad der Farbabweichung
V2



301228
WOODLAND BROWN RETTIFICATO 30x120
Cod. **92** □

301236
WOODLAND BROWN RETTIFICATO 30x120 **R10**
Cod. **92** □



301229
WOODLAND HONEY RETTIFICATO 30x120
Cod. **92** □

301237
WOODLAND HONEY RETTIFICATO 30x120 **R10**
Cod. **92** □



201212
WOODLAND BROWN RETTIFICATO 20x120
Cod. **92** □

201219
WOODLAND BROWN RETTIFICATO 20x120 **R10**
Cod. **92** □



201213
WOODLAND HONEY RETTIFICATO 20x120
Cod. **92** □

201220
WOODLAND HONEY RETTIFICATO 20x120 **R10**
Cod. **92** □



490511
WOODLAND BROWN MOSAICO MURETTO 2x10 SU RETE 20x40
Cod. **125** ○



490512
WOODLAND HONEY MOSAICO MURETTO 2x10 SU RETE 20x40
Cod. **125** ○

IMBALLI • PACKAGES • EMBALLAGES • FORMATE

	SCATOLA • BOX • BOITE • KARTON			PALLET • PALLETS • PALETTS • PALETTE		
	pz	m ^q	kg	box	m ^q	kg
30x120	3	1,08	24,80	40	43,20	1.010,00
30x120 R10	3	1,08	24,80	40	43,20	1.010,00
20x120	4	0,96	20,20	48	46,08	995,00
20x120 R10	4	0,96	20,20	48	46,08	995,00

IMBALLI • PACKAGES • EMBALLAGES • FORMATE

	SCATOLA • BOX • BOITE • KARTON			PALLET • PALLETS • PALETTS • PALETTE		
	pz	m ^q	kg	box	m ^q	kg
30x120	3	1,08	24,80	40	43,20	1.010,00
30x120 R10	3	1,08	24,80	40	43,20	1.010,00
20x120	4	0,96	20,20	48	46,08	995,00
20x120 R10	4	0,96	20,20	48	46,08	995,00



301230
WOODLAND TAUPE RETTIFICATO 30x120
Cod. 92 □

301238
WOODLAND TAUPE RETTIFICATO 30x120 R10
Cod. 92 □



201214
WOODLAND TAUPE RETTIFICATO 20x120
Cod. 92 □

201221
WOODLAND TAUPE RETTIFICATO 20x120 R10
Cod. 92 □



18,70 kg

490513
WOODLAND TAUPE MOSAICO MURETTO 2x10 SU RETE 20x40
Cod. 125 ○



301231
WOODLAND VANILLA RETTIFICATO 30x120
Cod. 92 □

301239
WOODLAND VANILLA RETTIFICATO 30x120 R10
Cod. 92 □



201215
WOODLAND VANILLA RETTIFICATO 20x120
Cod. 92 □

201222
WOODLAND VANILLA RETTIFICATO 20x120 R10
Cod. 92 □



18,70 kg

490514
WOODLAND VANILLA MOSAICO MURETTO 2x10 SU RETE 20x40
Cod. 125 ○

IMBALLI • PACKAGES • EMBALLAGES • FORMATE

	SCATOLA • BOX • BOITE • KARTON			PALLET • PALLETS • PALETTS • PALETTE		
	pz	m ^q	kg	box	m ^q	kg
30x120	3	1,08	24,80	40	43,20	1.010,00
30x120 R10	3	1,08	24,80	40	43,20	1.010,00
20x120	4	0,96	20,20	48	46,08	995,00
20x120 R10	4	0,96	20,20	48	46,08	995,00

IMBALLI • PACKAGES • EMBALLAGES • FORMATE

	SCATOLA • BOX • BOITE • KARTON			PALLET • PALLETS • PALETTS • PALETTE		
	pz	m ^q	kg	box	m ^q	kg
30x120	3	1,08	24,80	40	43,20	1.010,00
30x120 R10	3	1,08	24,80	40	43,20	1.010,00
20x120	4	0,96	20,20	48	46,08	995,00
20x120 R10	4	0,96	20,20	48	46,08	995,00

Pezzi speciali • Special trims • Pièces spéciales • Formstücke

Battiscopa



9,00 kg



9,00 kg

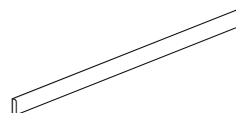

290650
WOODLAND BROWN
BATTISCOPA 5x60
Cod. **121** △

290651
WOODLAND HONEY
BATTISCOPA 5x60
Cod. **121** △

290652
WOODLAND TAUPE
BATTISCOPA 5x60
Cod. **121** △

290653
WOODLAND VANILLA
BATTISCOPA 5x60
Cod. **121** △

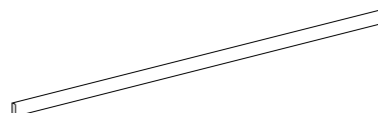

290656
WOODLAND BROWN
BATTISCOPA 5x120
Cod. **33** △

290657
WOODLAND HONEY
BATTISCOPA 5x120
Cod. **33** △

290658
WOODLAND TAUPE
BATTISCOPA 5x120
Cod. **33** △

290659
WOODLAND VANILLA
BATTISCOPA 5x120
Cod. **33** △

Gradino



19,00 kg

Angolari



20,00 kg

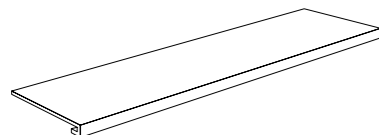

490515
WOODLAND BROWN
GRADINO 30x120
Cod. **114** ○

490516
WOODLAND HONEY
GRADINO 30x120
Cod. **114** ○

490517
WOODLAND TAUPE
GRADINO 30x120
Cod. **114** ○

490518
WOODLAND VANILLA
GRADINO 30x120
Cod. **114** ○

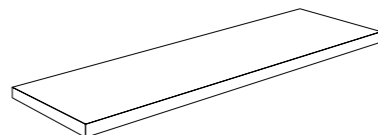

490533
WOODLAND BROWN
ANGOLARE 30x120
Cod. **110** ○

490534
WOODLAND HONEY
ANGOLARE 30x120
Cod. **110** ○

490535
WOODLAND TAUPE
ANGOLARE 30x120
Cod. **110** ○

490536
WOODLAND VANILLA
ANGOLARE 30x120
Cod. **110** ○

CARATTERISTICHE DI QUALITÀ Quality characteristics Caractéristiques de qualité Qualitätseigenschaften	NORMA Norm Norme Norme	REQUISITO NORMA Required standards Valeur prescrite selon la norme Normvorgabe	RISULTATO Result Résultat Ergebniss
Assorbimento d'acqua Water absorption of the body Absorption d'eau de support Wasseraufnahme des Scherbens	ISO 10545-3	≤ 0,5	Conforme Conformity Conforme Gemäss
Resistenza a flessione Breaking strenght Résistance à la flexion Biegefestigkeit	ISO 10545-4	≥ 35 N/mm ²	Conforme Conformity Conforme Gemäss
Resistenza all'abrasione Abrasion resistance Resistance a l'abrasion Abriebbestaendigkeit	EN ISO 10545-7		PEI IV
Resistenza al gelo Frost resistance Résistance au gel Frostbeständigkeit	ISO 10545-12	Nessun campione deve presentare rotture o alterazioni apprezzabili alla superficie No samples must show ruptures or noticeable surface alteration Aucuns enchantions doit présenter ruptures ou altérations appréciables de la surface Keines der Muster sollte Risse oder sichtbare Fehler der Oberflaeche zeigen	Conforme Conformity Conforme Gemäss
Resistenza all'attacco chimico Chemical resistance Résistance à l'attaque chimique Beständigkeit gegen chemikalien	ISO 10545-13		GA GLA
Resistenza agli sbalzi termici Thermal shock resistance Resistance aux ecart de température Temperaturwechselbeständigkeit	ISO 10545-5		Conforme Conformity Conforme Gemäss
Resistenza scivolosità Sliding resistance Resistance au glissement Rutschfestigkeit	DIN 51130 R		R9 - R10
Resistenza scivolosità Sliding resistance Resistance au glissement Rutschfestigkeit	DIN 51097 (A+B+C)	Versione R10	A+B
Coefficiente d'attrito dinamico Wet dynamic coefficient of friction Coefficient de friction dynamique Reibungskoeffizient Schlupfrigkeit (in Bewegung)	Bot 3000 E	DCOF ≥ 0,42	> 0,42
Lieve variazione Slight variation Légère variation Geringe Abweichung			V2

V1
Aspetto uniforme
Uniform appearance
Aspect uniforme
Einheitliches Aussehen

V2
Lieve variazione
Slight variation
Légère variation
Geringe Abweichung

V3
Moderata variazione
Moderate variation
Variation modérée
Mäßige Abweichung

V4
Forte stonalizzazione
Substantial variation
Effet dénuancé très accentué
Akzentuierte Variation

PER UNA POSA OTTIMALE DEL PRODOTTO CONSIGLIAMO SEMPRE DI MESCOLARE ALMENO TRE SCATOLE DI MATERIALE.

For the best product laying results, material from at least three boxes should be mixed.

Pour une pose excellente, nous recommandons toujours de mélanger le contenu d'au moins trois boîtes.

Für eine optimale Verlegung des Erzeugnisses empfehlen wir stets, mindestens drei Packungen Material anzumischen.

CONDIZIONI GENERALI DI VENDITA

General conditions of sale

Conditions Générales de vente

Allgemeine Geschäftsbedingungen

Condizioni generali di vendita

1. NORMATIVA CONTRATTUALE Le presenti condizioni generali, salvo modificazioni o deroghe concordate per iscritto, disciplinano tutti i contratti di vendita fra Gazzini S.p.A. e l'Acquirente. Le variazioni delle condizioni generali di vendita, le offerte, gli accrediti o gli abbuoni accordati dai nostri agenti o altri intermediari, non sono validi se non accettate per iscritto dalla nostra sede.

2. OGGETTO DELLA FORNITURA La fornitura comprende solamente i materiali, le prestazioni ed i quantitativi specificati nella nostra conferma d'ordine. Il testo della conferma d'ordine Gazzini S.p.A. prevarrà in ogni caso sul testo difforme della eventuale offerta o della ordinazione.

3. CONFERMA D'ORDINE Qualora nella conferma d'ordine Gazzini S.p.A. esistano differenze nei singoli elementi che la compongono rispetto alle intese od alle ordinazioni, l'Acquirente che non abbia contestato per iscritto entro 7gg dalla ricezione della nostra conferma s'intende che l'abbia accettata così come è stata redatta. Il cliente si impegna a comunicare a Gazzini S.p.A. l'eventuale variazione del luogo di destinazione della merce, se diverso da quello citato nella conferma d'ordine, entro e non oltre il giorno previsto per il ritiro presso Gazzini S.p.A., mediante invio, tramite posta, fax o e-mail, dei dati identificativi del destinatario delle merci e del luogo presso il quale dovrà essere effettuata la consegna. In mancanza di tale comunicazione la destinazione originariamente indicata si intende tacitamente confermata.

4. PREZZI I prezzi indicati sui listini Gazzini S.p.A. non sono impegnativi: di conseguenza ci riserviamo il diritto di modificarli prima dell'accettazione dell'ordine. I prezzi pattuiti per ogni singola vendita si intendono al netto, per contanti per consegna franco stabilimento, salvo diversa pattuizione scritta. Se fra la data di ordinazione (anche dopo la conferma d'ordine) e quella di consegna si verificassero aumenti nei costi delle materie prime, della manodopera, dei combustibili, nelle spese di produzione, di trasporto ecc., Gazzini S.p.A. potrà aumentare il prezzo convenuto dandone comunicazione scritta all'Acquirente anche a mezzo fax o posta elettronica. Tuttavia qualora detto prezzo superi del 20% quello convenuto al momento dell'ordinazione, l'Acquirente potrà recedere dal contratto notificandoci per raccomandata tale sua volontà entro il termine perentorio di 10 gg dal ricevimento dell'avviso dell'aumento di prezzo. In difetto, il nuovo prezzo s'intenderà accettato.

5. CONSEGNE La vendita è sempre franco stabilimento di Gazzini S.p.A.. La merce viaggia a rischio e pericolo dell'Acquirente ed ogni nostra responsabilità cessa con la consegna al vettore, nei confronti del quale l'Acquirente, effettuate le opportune verifiche, dovrà sporgere eventuali reclami. Le spedizioni, via mare o via terra, concernenti forniture sull'estero, vengono effettuate in base alle condizioni scelte di volta in volta, riportate negli "Incoterms" approvati dalla Camera di Commercio Internazionale.

6. TERMINI DI CONSEGNA I termini di consegna hanno carattere indicativo: eventuali ritardi nelle consegne, interruzioni, sospensioni totali o parziali delle forniture non daranno diritto ad indennizzi o risarcimento danni se non diversamente concordato per iscritto.

7. CAMPIONI I dati figuranti nei documenti illustrativi di Gazzini S.p.A., così come le caratteristiche dei campioni e modelli da quest'ultimo inviati l'Acquirente, hanno carattere di indicazioni approssimative. Questi dati non hanno valore impegnativo se non nella misura in cui siano stati espressamente menzionati come tali nell'offerta o nell'accettazione scritta di Gazzini S.p.A..

8. PAGAMENTI Le fatture di Gazzini S.p.A. vengono emesse il giorno della fornitura e devono essere pagate al netto alla scadenza pattuita. Ogni e qualsiasi obbligazione di pagamento tra le parti contraenti deve essere adempiuta presso la sede di Gazzini S.p.A. Eventuali pagamenti fatti ad agenti, rappresentanti o ausiliari di commercio di Gazzini S.p.A. non si intendono effettuati finché le relative somme non pervengano a Gazzini S.p.A.. Il pagamento dovrà essere effettuato, salvo diverso accordo scritto, contestualmente alla consegna, presso l'Istituto bancario indicato di Gazzini S.p.A.. Qualsiasi ritardo o irregolarità nel pagamento dà a Gazzini S.p.A. il diritto di sospendere le forniture o di risolvere i contratti in corso, anche se non relativi ai pagamenti in questione, nonché il diritto al risarcimento degli eventuali danni. Gazzini S.p.A. ha comunque diritto – a decorrere dalla scadenza del pagamento, senza necessità di messa in mora - agli interessi moratori nella misura prevista dal d.lgs. 09/10/2002 n. 231. In caso d'inadempimento, anche solo parziale, gli interessi moratori sull'importo non pagato decorreranno dal giorno della consegna anche se il termine di pagamento era stato convenuto a data successiva. Nessuna contestazione o controversia inerente alla qualità della merce, a vizi o difetti, o a qualsiasi altro aspetto del contratto, sarà efficace e potrà essere presa in considerazione, e così pure nessuna azione potrà essere iniziata se non dopo l'avvenuto integrale pagamento del prezzo (clausola solve et repete). Non è ammessa compensazione con eventuali crediti, comunque insorti, nei confronti di Gazzini S.p.A..

9. GARANZIE E RECLAMI La qualità del materiale ceramico è definita sulla base delle vigenti normative internazionali applicabili alla corrispondente classe di prodotto. Gazzini S.p.A. garantisce la sola merce fornita in prima scelta. Reclami relativi a merce in scelta differente dalla prima (commerciale, seconda, terza, secondaria, stock, etc.) non saranno presi in considerazione, né viene data implicitamente od esplicitamente alcun tipo di garanzia su tali materiali. È fatto obbligo all'Acquirente di verificare la merce in termini di qualità e quantità entro breve tempo dal ricevimento e, in caso di reclamo, darne comunicazione per iscritto entro e non oltre 8 (otto) giorni dal ricevimento stesso pena la decadenza da ogni diritto. Il materiale considerato difettoso dovrà essere tenuto a disposizione di Gazzini S.p.A. per le verifiche che riterrà opportuno effettuare; ogni ulteriore azione (restituzione, riparazione o altro) dovrà essere preventivamente autorizzata per iscritto da Gazzini S.p.A.. Reclami e richieste di intervento in garanzia dopo la posa in opera non saranno presi in esame nel caso in cui il difetto contestato dovesse risultare palese (es. sbeccate, difetti dimensionali, differenze di tono, ecc.). Si precisa che la prima scelta può contenere piastrelle difettose nel limite del 5% e che la tonalità del materiale fornito può differire dal campione esposto, essendo la ceramica intrinsecamente variabile come aspetto. I reclami imputati a difetti o vizi occulti dovranno essere formalizzati per iscritto entro 8 (otto) giorni dalla scoperta e, in ogni caso, entro un anno dalla consegna, pena la decadenza da ogni diritto alla garanzia e di risarcimento. La comunicazione dovrà contenere, oltre i dati di fatturazione, una precisa descrizione del vizio, un preventivo dei costi di riparazione o modificazione del prodotto; in mancanza di questi dati il reclamo si considera nullo. Qualora il reclamo dovesse risultare infondato l'Acquirente dovrà risarcire Gazzini S.p.A. di tutte le spese sostenute per l'accertamento (viaggi, perizie, ecc.). L'obbligo di Gazzini S.p.A. è, in ogni caso, limitato alla sostituzione dei soli pezzi difettosi o alla riparazione, con espressa esclusione di ulteriori diversi indennizzi quali, a titolo indicativo ma non limitativo, per costi di rimozione e risistemazione di mobili, attrezzature, macchinari ecc., mancati guadagni per interruzione o sospensione di attività, disagi, danni indiretti ecc. La presenza di piastrelle difettose non inficia la qualità dell'intera fornitura né comporta l'obbligo della integrale sostituzione. I limiti temporali della durata della garanzia sono quelli stabiliti dal codice civile italiano.

10. RISERVATO DOMINIO La vendita della merce viene effettuata con la clausola del riservato dominio; pertanto, nel caso in cui il pagamento, per accordi contrattuali, debba essere effettuato, in tutto o in parte dopo la consegna, i prodotti consegnati restano di proprietà Gazzini S.p.A. fino all'integrale pagamento del prezzo.

11. CESSIONE DEL CONTRATTO L'Acquirente non può cedere la sua posizione nel contratto od in singoli rapporti obbligatori da questo derivanti senza l'accettazione scritta di Gazzini S.p.A.: anche in tal caso l'Acquirente rimane comunque solidalmente responsabile col cessionario per le obbligazioni cedute.

12. PROPRIETÀ INDUSTRIALE E DISTRIBUZIONE SELETTIVA - LIMITI ALLA RIVENDITA Gazzini S.p.A. è titolare e legittimo detentore di esclusive relative ai marchi, a disegni e brevetti di invenzione. Al fine di garantire al meglio il rispetto dei diritti esclusivi di Gazzini S.p.A., nonché le aspettative dei consumatori finali in ordine alle caratteristiche qualitative attese, Gazzini S.p.A. gestisce le forniture dei propri prodotti mediante un sistema di distribuzione selettiva. Le forniture ricevute da Gazzini S.p.A. e dai propri punti vendita selettivi autorizzati sono destinate all'installazione presso l'utente finale e non è consentita altra forma di rivendita a ulteriori intermediari commerciali diversi dagli utenti finali, salvo previa autorizzazione iscritta da parte di Gazzini S.p.A.. La rivendita della merce in violazione di tale divieto deve considerarsi pertanto non consentita ed equiparata ad uso illecito dei diritti di proprietà industriale e intellettuale di Gazzini S.p.A., con diritto di Gazzini S.p.A. di chiederne il sequestro presso qualunque detentore. Gazzini S.p.A. si riserva il diritto di procedere giudizialmente nei confronti di chiunque sia coinvolto in rivendite non autorizzate.

13. LEGGE DEL CONTRATTO - FORO COMPETENTE Il contratto è disciplinato dalla legge italiana, compresi gli Usi di settore della Provincia di Reggio Emilia. Per qualsiasi controversia comunque derivante dal contratto di fornitura, tanto da parte di Gazzini S.p.A. come da parte dell'Acquirente, è esclusivamente competente il Tribunale di Reggio Emilia. È comunque in facoltà di Gazzini S.p.A. adire autorità giudiziarie diverse.

General conditions of sale

1. CONTRACTUAL REGULATIONS These general conditions, subject to modifications or waivers agreed in writing, govern all sales contracts between Gazzini S.p.A. and the Purchaser. Variations in the general conditions of sale, offers, credits or allowances agreed by our agents or other intermediaries, are not valid unless accepted in writing by our head office.

2. SUBJECT OF THE SUPPLY The supply includes only the materials, services and quantities specified in our order confirmation. The text of the Gazzini S.p.A. order confirmation shall prevail in any case over any differing text of the offer or order.

3. ORDER CONFIRMATION If, in the Gazzini S.p.A. order confirmation, there are differences in the individual elements comprising it, compared with the agreements or the orders, the Purchaser is understood to have accepted our confirmation as it was drawn up, unless an objection to it is made in writing within 7 days of receipt of it. The customer undertakes to notify Gazzini S.p.A. of the place of destination of the goods, if different from the address quoted on the order confirmation. In the case of any variation in the place of destination, the identification data of the destination address for the goods and the place where delivery is to be made must be sent by post, fax or email, before the day laid down for collection at Gazzini S.p.A.'s premises. If no notification is received, the destination originally shown shall be understood as tacitly confirmed.

4. PRICES The prices shown in the Gazzini S.p.A. price-lists are not binding: we therefore reserve the right to modify them before acceptance of the order. The prices agreed upon for each individual sale are understood as net, for cash and for delivery ex-works, subject to any different written stipulation. If there should be increases in costs of raw materials, labour, fuel, production or transport costs, etc. between the order date (even after the order confirmation) and the delivery date, Gazzini S.p.A. may increase the agreed price, giving written notification to the Purchaser also by fax or email. However, if this price should exceed the price agreed at the time of order by 20%, the Purchaser may withdraw from the contract by notifying us by registered letter of his desire to do so within the deadline of 10 days from receipt of the notice of price increase. If he fails to do so, the price shall be understood as accepted.

5. SHIPMENTS The sale is always ex-works at the Gazzini S.p.A. premises. The goods travel at the Purchaser's risk and our liability ends with delivery to the carrier, to whom the Purchaser after performing suitable checks must make any claims that may arise. Shipments by sea or land concerning supplies carried out abroad are performed according to conditions chosen on a time-by-time basis, shown in the "Incoterms" approved by the International Chamber of Commerce.

6. DELIVERY TIMES Delivery times are by way of indication only: any delays in delivery and interruptions and total or partial suspensions of supplies shall not give rise to an entitlement to refunds or claims for compensation unless otherwise agreed in writing.

7. SAMPLES The data shown in the Gazzini S.p.A. illustrative documents, as well as the characteristics of samples and models sent by Gazzini S.p.A. to the Purchaser, is of an approximately indicative nature. This data has no binding value except to the extent to which they were expressly mentioned as such in Gazzini S.p.A.'s offer or written acceptance.

8. PAYMENTS Gazzini S.p.A.'s invoices are issued on the day of supply and must be paid net on the agreed expiry date. Each and every obligation for payment between the contracting parties must be performed at Gazzini S.p.A.'s head office. Any payments made to agents, sales representatives or assistants of Gazzini S.p.A. are not considered to have been carried out until the relative sums have reached Gazzini S.p.A.. Payment must be carried out, subject to any other written agreement, at the same time as the delivery, to the bank indicated by Gazzini S.p.A.. Any delay or irregularity in payment gives Gazzini S.p.A. the right to suspend supplies or to terminate current contracts, even if they do not relate to the payments in question, as well as the right to claim any damages. Gazzini S.p.A. is in any case entitled – starting from the payment expiry date, and without the need for notice of default – to the interest on arrears to the extent provided for by Italian Legislative Decree No. 231 of 09/10/2002. In the case of non-fulfilment, even only partial, the interest on arrears for the unpaid amount shall start from the day of delivery even if the payment term was agreed on as a later date. No objection or dispute referring to the quality of the goods or to flaws or defects or to any other aspect of the contract shall be valid and can be taken into consideration; in addition, no action may be started up until after payment has been made of the entire amount of the price (solve et repete clause). Compensation to Gazzini S.p.A., with any credits, however they may have arisen, is not permitted.

9. GUARANTEES AND COMPLAINTS The quality of the ceramic material is defined on the basis of the prevailing international regulations applicable to the corresponding product class. Gazzini S.p.A. guarantees only goods supplied as prime quality. Complaints relating to goods other than of prime quality commercial, second, third, secondary, stock, etc.) shall not be taken into consideration, nor will any kind of guarantee be given, either implicitly or explicitly, on these materials. The Purchaser is obliged to check the goods in terms of quality and quantity within a short time after receipt and, in the case of a complaint, to give notification of this in writing no later than 8 (eight) days from receipt of the goods; failure to do so will incur the forfeiture of all rights. Material deemed to be defective must be held at Gazzini S.p.A.'s disposal for the checks that it will consider suitable to carry out; any further action (return, repair or other) must be authorized in advance by Gazzini S.p.A. in writing. Complaints and requests for intervention under guarantee after the material has been laid shall not be taken into account if the defect reported is evident (e.g. chips, defects of size, differences in colour shade, etc.). It is made clear that the prime quality may contain defective tiles up to a limit of 5% and that the colour shades of the material supplied may differ from the sample displayed, since ceramic is intrinsically variable in appearance. Complaints attributed to latent faults or defects must be formalized in writing within 8 (eight) days from their discovery and, in any case, within one year from delivery; failure to do so will incur the forfeiture of all rights under the guarantee and to compensation. As well as the invoice details, the notification must contain a precise description of the defect and an estimate of costs for repair or modification of the product; failure to notify this data will cause the complaint to be deemed invalid. If the complaint should prove to be unfounded the Purchaser must reimburse Gazzini S.p.A. for all the expenses incurred for assessment (travelling expenses, surveys, etc.). Gazzini S.p.A.'s obligation is, in any case, limited to replacing the defective pieces only or to repairing them, with the express exclusion of other, further indemnities such as, by way of a non-limiting example, for costs of removing and re-installing furniture, equipment, machinery, etc., or loss of earnings for interruption or suspension of business, inconvenience, consequential damages, etc. The presence of defective tiles does not invalidate the quality of the entire supply, nor does it incur the obligation for its entire replacement. The time limits for the duration of the guarantee are as established by the Italian Civil Code.

10. RETENTION OF TITLE Sale of the goods is carried out with the retention of title clause; therefore if payment, by contractual agreements, must be carried out wholly or in part after delivery, the products delivered remain the property of Gazzini S.p.A. until the entire price has been paid.

11. TRANSFER OF CONTRACT The Purchaser may not transfer his position in the contract or in individual binding agreements deriving from this without Gazzini S.p.A.'s written acceptance: also in this case the Purchaser anyway remains jointly liable with the transferee for the obligations transferred.

12. INDUSTRIAL PROPERTY AND SELECTIVE DISTRIBUTION - LIMITS ON RESALE Gazzini S.p.A. is the owner and legal holder of the exclusive rights to brand names, designs and patents. In order to guarantee full respect for Gazzini S.p.A.'s exclusive rights, as well as the end consumers' expectations with regard to expected quality characteristics, Gazzini S.p.A. manages the supplies of its products by means of a selective distribution system. Supplies received from Gazzini S.p.A. and from its authorized selective sales outlets are designed for installation at the end user's premises and no other form of resale to further sales agents other than the end users is permitted, unless with Gazzini S.p.A.'s prior written authorization. Goods that are re-sold in breach of this provision must therefore be considered as not permitted and treated as an unlawful use of Gazzini S.p.A.'s industrial and intellectual property rights, with Gazzini S.p.A.'s right to ask for them to be seized at the premises of any holder. Gazzini S.p.A. reserves the right to take legal proceedings against anyone who is involved in unauthorized re-selling.

13. LAW GOVERNING THE CONTRACT - PLACE OF JURISDICTION The contract is governed by Italian law, including the customs of the sector in Modena Province. For any dispute that may in any case derive from the supply contract, either on the part of Gazzini S.p.A. or on the part of the Purchaser, the Modena Court has exclusive competence. Gazzini S.p.A. nevertheless has the right to resort to different judicial authorities.

1. NORME CONTRACTUELLE Sauf modifications ou dérogations convenues par écrit, les présentes conditions générales s'appliquent à tous les contrats de vente entre Gazzini S.p.A. et l'Acquéreur. Les variations des conditions générales de vente, les offres, crédits ou réductions accordés par nos agents ou d'autres intermédiaires ne sont valables que s'ils ont été acceptés par écrit par notre siège.

2. OBJET DE LA FOURNITURE La fourniture correspond uniquement aux matériaux, prestations et quantités spécifiés dans notre confirmation de commande. Le texte de la confirmation de commande de Gazzini S.p.A. prévaut dans tous les cas par rapport au texte non conforme de la commande ou de l'offre éventuelle.

3. CONFIRMATION DE COMMANDE En cas de divergences des éléments de la confirmation de commande de Gazzini S.p.A. par rapport aux accords ou aux commandes, l'Acquéreur pourra formuler une réclamation écrite dans les 7 jours suivant la réception de notre confirmation. Passé ce délai, la commande sera considérée comme ayant été acceptée telle qu'elle a été rédigée. Le client s'engage à communiquer à Gazzini S.p.A. l'éventuelle variation du lieu de destination de la marchandise, si différente de celle prévue dans la confirmation de la commande, au plus tard le jour prévu du retrait chez Gazzini S.p.A., par l'envoi, par poste, fax ou e-mail, des données d'identification du destinataire des marchandises et du lieu où la livraison devra être effectuée. En cas de manquement de communication la destination indiquée à l'origine sera tacitement confirmée.

4. PRIX Les prix indiqués sur les catalogues Gazzini S.p.A. ne sont pas contraignants : nous nous réservons par conséquent le droit de les modifier préalablement à l'acceptation de la commande. Les prix convenus pour chaque vente s'entendent hors taxes, payés au comptant pour une livraison franco usine, sauf accord contraire stipulé par écrit. Si des hausses du coût des matières premières, de la main-d'oeuvre, des combustibles, des frais de production et de transport, etc. apparaissent entre la date de commande (même après la confirmation de commande) et la date de livraison, Gazzini S.p.A. pourra augmenter le prix convenu en informant l'Acquéreur par écrit, y compris par fax ou courrier électronique. Cependant, si ledit prix dépasse de 20 % celui convenu lors de la commande, l'Acquéreur pourra résilier le contrat en nous faisant part de sa volonté par lettre recommandée dans un délai préemptoire de 10 jours à compter de la réception de l'avis d'augmentation du prix. Dans le cas contraire, le nouveau prix sera considéré comme ayant été accepté.

5. LIVRAISONS La vente s'entend toujours franco usine Gazzini S.p.A.. La marchandise voyage aux risques et périls de l'Acquéreur. Toutes nos responsabilités prennent fin avec la remise au transporteur, auquel l'Acquéreur, après les contrôles de rigueur, devra s'adresser pour d'éventuelles réclamations. Les expéditions de fournitures à l'étranger par voie terrestre ou maritime sont effectuées selon les conditions choisies d'une fois sur l'autre, conformément aux Incoterms approuvés par la Chambre de commerce internationale.

6. DÉLAIS DE LIVRAISON Les délais de livraison sont donnés à titre indicatif : les éventuels retards de livraison, les interruptions, les suspensions totales ou partielles de fourniture n'ouvriront pas droit à une indemnisation ou à des dommages-intérêts, sauf accord contraire stipulé par écrit.

7. ÉCHANTILLONS Les informations reportées sur les documents d'illustration de Gazzini S.p.A., de même que les caractéristiques des échantillons et modèles envoyés par Gazzini S.p.A. à l'Acquéreur, sont données à titre purement indicatif. Ces données n'ont aucune valeur contraignante, à moins que cela ait été indiqué expressément dans l'offre ou dans l'acceptation écrite de Gazzini S.p.A..

8. PAIEMENTS Les factures de Gazzini S.p.A., émises au jour de la fourniture, doivent être payées conformément à l'échéance prévue. Toute obligation de paiement entre les parties contractantes doit être exécutée auprès du siège de Gazzini S.p.A.. Les paiements éventuels faits à des agents, représentants ou auxiliaires de commerce de Gazzini S.p.A. ne seront considérés comme effectifs qu'à compter de la réception par Gazzini S.p.A. des sommes dues. Sauf accord contraire stipulé par écrit, le paiement devra être effectué au moment de la livraison auprès de l'institut bancaire indiqué par Gazzini S.p.A.. Tout retard ou toute irrégularité de paiement donnera à Gazzini S.p.A. le droit de suspendre les fournitures ou de résilier les contrats en cours, y compris ceux qui ne sont pas en lien avec les paiements en question, et de demander le remboursement des dommages éventuellement subis. Gazzini S.p.A. peut quoi qu'il en soit prétendre – à compter de l'arrivée à échéance du paiement, et sans nécessité de mise en demeure – à des intérêts moratoires conformément à la loi n° 231 du 09/10/2002. En cas de manquement même partiel, les intérêts moratoires sur le montant restant dû courent à compter du jour de la livraison, même si le délai de paiement convenu est fixé à une date ultérieure. Aucune réclamation ni aucun litige portant sur la qualité de la marchandise, des vices ou des défauts ou tout autre aspect du contrat, n'aura de valeur et ne pourra être pris en considération, de même qu'aucune action ne pourra être initiée avant le paiement intégral du prix (clause solve et repete). Les compensations par d'éventuels crédits, même existants, vis-à-vis de Gazzini S.p.A., ne sont pas admises.

9. GARANTIES ET RÉCLAMATIONS La qualité des matériaux céramiques est définie sur la base des normes internationales en vigueur qui s'appliquent à la classe de produit correspondante. La garantie de Gazzini S.p.A. ne porte que sur la marchandise de premier choix fournie. Les réclamations relatives à des marchandises autres que celles de premier choix (commercial, 2e et 3e choix, secondaire, stock, etc.) ne seront pas prises en considération. Il ne sera donné aucun type de garantie sur ces matériaux, ni implicitement ni explicitement. Obligation est faite à l'Acquéreur de contrôler la qualité et la quantité de la marchandise rapidement après la livraison et, en cas de réclamation, d'en donner communication par écrit dans les 8 (huit) jours suivant la réception sous peine de déchéance de ses droits. Les matériaux considérés comme défectueux devront être laissés à la disposition de Gazzini S.p.A. pour les contrôles jugés opportuns ; toute action ultérieure (restitution, réparation ou autre) devra avoir été préalablement autorisée par écrit par Gazzini S.p.A.. Les réclamations et demandes d'intervention en garantie postérieures à la pose ne seront pas prises en considération si le défaut constaté est manifeste (ex. pièces ébréchées, défauts dimensionnels, différences de teinte, etc.). Il est précisé que le premier choix peut présenter des carreaux défectueux dans une limite de 5 % et que la teinte du matériau fourni peut différer de l'échantillon exposé, l'aspect de la céramique étant intrinsèquement variable. Les réclamations pour des défauts ou des vices cachés devront être adressées par écrit dans les 8 (huit) jours suivant leur découverte, et dans tous les cas dans l'année suivant la livraison, sous peine d'une déchéance de tout droit à la garantie et au remboursement. La réclamation devra mentionner, outre les références de facturation, une description précise du vice et un devis des coûts de réparation ou de modification du produit ; en l'absence de ces informations, la réclamation sera considérée comme nulle et non avenue. Si la réclamation se révèle infondée, l'Acquéreur devra rembourser à Gazzini S.p.A. toutes les dépenses engagées dans le cadre des contrôles (déplacements, expertises, etc.) effectués. Les obligations de Gazzini S.p.A. se limitent quoi qu'il en soit au remplacement des pièces défectueuses ou à leur réparation, à l'exclusion expresse de toute indemnisation ultérieure comme, à titre indicatif mais sans limitation aucune, pour des coûts de déplacement et de remise en place de mobilier, de matériel, de machines, etc., de manques à gagner du fait d'une interruption ou d'une suspension d'activité, de perturbations, de dommages indirects, etc. La présence de carreaux défectueux n'invalide pas la qualité de l'ensemble de la fourniture et n'entraîne aucune obligation de remplacement intégral. Les limites temporelles de la durée de garantie sont celles définies par le code civil italien.

10. RÉSERVE DE PROPRIÉTÉ La vente de la marchandise s'effectue avec la clause de réserve de propriété. Par conséquent, si le paiement, du fait d'accords contractuels, est effectué en tout ou partie après la livraison, les produits livrés resteront la propriété de Gazzini S.p.A. jusqu'au paiement intégral du prix.

11. CESSIION DU CONTRAT L'Acquéreur ne peut pas céder ses droits et obligations ni chacune des relations obligatoires nés du présent contrat sans l'accord écrit de Gazzini S.p.A.: même dans ce cas, l'Acquéreur restera solidaire du cessionnaire vis-à-vis des obligations cédées.

12. PROPRIÉTÉ INDUSTRIELLE ET DISTRIBUTION SÉLECTIVE - LIMITES À LA REVENTE Gazzini S.p.A. est le titulaire et propriétaire légitime des exclusivités relatives aux marques, dessins et brevets d'invention. Pour garantir au mieux le respect des droits exclusifs de Gazzini S.p.A. et les attentes du consommateur final en matière de caractéristiques qualitatives, Gazzini S.p.A. gère la fourniture de ses produits par l'intermédiaire d'un système de distribution sélective. Les fournitures acquises auprès de Gazzini S.p.A. et de ses points de vente sélectifs agréés sont destinées à une installation auprès de l'utilisateur final ; aucune autre forme de revente à des intermédiaires commerciaux autres que les utilisateurs finals n'est autorisée, sauf autorisation préalable de Gazzini S.p.A. stipulée par écrit. Toute revente de marchandise en violation de ce principe doit donc être considérée comme interdite et assimilée à un usage illicite des droits de propriété industrielle et intellectuelle de Gazzini S.p.A., donnant droit à Gazzini S.p.A. de demander la saisie de ladite marchandise auprès de son détenteur. Gazzini S.p.A. se réserve le droit de poursuivre en justice quiconque serait impliqué dans des reventes non autorisées.

13. LOI APPLICABLE ET JURIDICTION COMPÉTENTE Le contrat est régi par la loi italienne, y compris les Usages de branche de la Province de Reggio Emilia. Le tribunal de Reggio Emilia est exclusivement compétent pour tout litige relatif au contrat de fourniture entre Gazzini S.p.A. et l'Acquéreur. Gazzini S.p.A. garde néanmoins la faculté de saisir d'autres autorités judiciaires.

1. VERTRAGSVORSCHRIFTEN Alle Verkaufsverträge zwischen Gazzini S.p.A. und dem Käufer werden, vorbehaltlich schriftlich vereinbarter Änderungen oder Abweichungen, durch die vorliegenden allgemeinen Geschäftsbedingungen geregelt. Die Abänderungen der allgemeinen Geschäftsbedingungen, die Angebote, die von unseren Handelsagenten oder anderen Vermittlern gewährten Gutschriften oder Nachlässe haben nur Gültigkeit, sofern sie von unserem Sitz schriftlich angenommen wurden.

2. GEGENSTAND DER LIEFERUNG Die Lieferung umfasst nur die Materialien, Leistungen und Mengen, die in unserer Auftragsbestätigung angegeben sind. Der Text der Auftragsbestätigung von Gazzini S.p.A. hat auf jeden Fall Vorrang gegenüber dem Text, der von dem eventuellen Angebot oder der Bestellung abweichen sollte.

3. AUFTRAGSBESTÄTIGUNG Falls in der Auftragsbestätigung von Gazzini S.p.A. Unterschiede der darin aufgelisteten einzelnen Elemente gegenüber den Vereinbarungen oder Bestellungen bestehen, gilt die Bestätigung in ihrer abgefassten Form als angenommen, sofern der Käufer sie nicht binnen 7 Tagen nach Erhalt unserer Bestätigung schriftlich beanstandet hat.

4. PREISE Die auf den Gazzini S.p.A.-Preislisten angeführten Preise sind unverbindlich: Demzufolge behalten wir uns das Recht vor, sie vor der Auftragsannahme abzuändern. Sofern keine anderen schriftlichen Vereinbarungen vorliegen, verstehen sich die für jeden Einzelverkauf vereinbarten Preise netto, gegen bar, Lieferung ab Werk. Sollten zwischen dem Bestelldatum (auch nach der Auftragsbestätigung) und dem Lieferdatum ein Kostenanstieg der Rohstoffe, Löhne, Brennstoffe, Herstellung, des Transports, usw. auftreten, kann Gazzini S.p.A. den vereinbarten Preis erhöhen, indem er dies dem Käufer schriftlich, auch mittels Fax oder E-Mail, mitteilt. Sollte besagter Preis jedoch den bei der Bestellung vereinbarten Preis um 20% übersteigen, hat der Käufer die Möglichkeit, vom Vertrag zurückzutreten, indem er uns binnen der bindenden Frist von 10 Tagen nach Erhalt der Mitteilung bez. des Preisanstiegs seinen Willen per Einschreiben meldet. In Ermangelung dessen gilt der neue Preis als angenommen.

5. LIEFERUNGEN Der Verkauf ist immer ab Gazzini S.p.A.-Werk. Der Warentransport erfolgt auf Risiko und Gefahr des Käufers. Unsere Haftung endet mit der Übergabe an den Frachtführer, an den der Käufer nach angemessener Überprüfung eventuelle Beanstandungen zu richten hat.

Auslandslieferungen auf dem See- oder Landweg werden auf der Grundlage der von Fall zu Fall gewählten Bedingungen vorgenommen, die in den von der Internationalen Handelskammer gebilligten "Incoterms" aufgeführt sind.

6. LIEFERBEDINGUNGEN Die Lieferbedingungen sind hinweisend: Eventuelle Lieferverzögerungen, Unterbrechungen, komplette oder partielle Einstellungen der Lieferungen berechtigen weder zu einer Entschädigung noch zu einem Schadensersatz, sofern keine anderen schriftlichen Vereinbarungen vorliegen.

7. MUSTER Die auf den veranschaulichenden Dokumenten von Gazzini S.p.A. abgebildeten Angaben sowie die Eigenschaften der vom Letztgenannten dem Käufer zugesandten Muster und Modelle sind als ungefähre Angaben zu verstehen. Es handelt sich nicht um verbindliche Angaben, sofern sie nicht ausdrücklich als derartig im Angebot oder in der schriftlichen Annahme von Gazzini S.p.A. erwähnt wurden.

8. ZAHLUNGEN Die Rechnungen von Gazzini S.p.A. werden am Tag der Lieferung ausgestellt und sind netto innerhalb der vereinbarten Frist zu bezahlen.

Jegliche Zahlungsverpflichtung zwischen den Vertragsparteien ist am Gazzini S.p.A.-Sitz zu erfüllen. Eventuell an Handelsagenten, Vertreter oder Geschäftshelfer von Gazzini S.p.A. geleistete Zahlungen verstehen sich so lange als nicht vorgenommen, bis die bezüglichen Summen bei Gazzini S.p.A. eingehen. Die Bezahlung hat, vorbehaltlich anderer schriftlicher Vereinbarungen, unmittelbar nach der Lieferung beim Bankinstitut zu erfolgen, das von Gazzini S.p.A. angegeben wurde. Jegliche Zahlungsverzögerungen oder –unregelmäßigkeiten geben Gazzini S.p.A. das Recht, die Lieferungen einzustellen und die laufenden Verträge aufzulösen, auch wenn sie sich nicht auf die zutreffenden Zahlungen beziehen, sowie das Recht auf den Ersatz etwaiger Schäden. Gazzini S.p.A. hat auf jeden Fall Anspruch auf die Verzugszinsen – ab der Zahlungsfrist und ohne die Notwendigkeit einer Inverzugsetzung – in der laut Gesetzesverordnung Nr. 231 vom 09.10.2002 vorgesehenen Höhe. Im Falle einer auch nur teilweisen Nichterfüllung laufen die Verzugszinsen für den nicht bezahlten Betrag ab dem Tag der Lieferung, auch wenn als Zahlungsfrist ein späteres Datum vereinbart wurde. Keine Beanstandung oder Streitigkeit bezüglich der Warenqualität, Mängel oder Defekte, oder jedes anderen Vertragsaspekts ist wirksam und kann in Betracht gezogen werden, und gleichermaßen kann keine Klage eingeleitet werden, sofern keine vollständige Bezahlung des Preises erfolgte (Klausel solve et repete). Die Verrechnung mit eventuell entstandenen Forderungen gegen Gazzini S.p.A. ist unzulässig.

9. GARANTIE UND BEANSTANDUNGEN Die Qualität des Keramikmaterials wird auf der Grundlage der geltenden internationalen Rechtsvorschriften festgelegt, die auf die jeweilige Produktklasse Anwendung finden. Gazzini S.p.A. garantiert nur die als erste Wahl gelieferte Ware. Beanstandung über die nicht zur ersten Klasse gehörenden Waren (kommerzielle, zweite, dritte, zweitrangige Wahl, Lagerbestand, usw.) bleiben unberücksichtigt, wobei auf diese Materialien keine Art von Garantie, weder implizit noch explizit, erteilt wird. Der Käufer ist verpflichtet, die Ware binnen kurzer Zeit ab Erhalt auf Qualität und Quantität zu prüfen und bei einer Beanstandung diese schriftlich binnen spätestens 8 (acht) Tagen ab Warenerhalt mitzuteilen, da andernfalls jeglicher Anspruch verwirkt. Die als fehlerhaft betrachtete Ware ist Gazzini S.p.A. für seine als angemessen betrachteten Überprüfungen verfügbar zu halten; jeder weitere Vorgang (Rückerstattung, Reparatur oder sonstiges) bedarf der vorherigen schriftlichen Genehmigung von Gazzini S.p.A.. Beanstandungen und Beantragungen von Garantieeingriffen nach erfolgter Verlegung werden nicht in Betracht gezogen, sofern sich der beanstandete Defekt als offensichtlich erweisen sollte (zum Beispiel Schlagstellen, Maßunterschiede, Tonabweichungen, usw.). Es wird präzisiert, dass die erste Wahl bis zu 5% fehlerhafte Fliesen enthalten und die Farbgebung des gelieferten Materials vom ausgestellten Muster abweichen darf, da Keramik von Natur aus unterschiedlich aussehen kann. Auf verborgene Fehler oder Mängel bezogene Beanstandungen sind schriftlich binnen 8 (acht) Tagen ab ihrer Feststellung und auf jeden Fall binnen einem Jahr ab Lieferung zu formalisieren, da andernfalls die Verwirkung jeglichen Anspruchs auf Garantie und Entschädigung droht. Die Mitteilung muss neben den Rechnungsdaten eine genaue Beschreibung des Mangels und einen Kostenvoranschlag der Reparatur oder Änderung des Produkts enthalten; in Ermangelung dieser Angaben wird die Beanstandung als nichtig betrachtet. Sollte sich die Beanstandung als unbegründet erweisen, muss der Käufer Gazzini S.p.A. alle für die Überprüfung aufgetragenen Kosten (Reisen, Sachverständigengutachten, usw.) vergüten. Die Pflicht von Gazzini S.p.A. beschränkt sich auf jeden Fall allein auf den Ersatz nur der fehlerhaften Teile oder auf die Reparatur, mit ausdrücklichem Ausschluss anderweitiger Entschädigungen wie beispielsweise - aber nicht ausschließlich - für Kosten zur Beseitigung und Wiederherrichtung von Möbeln, Ausrüstungen, Maschinen, usw., entgangene Gewinne wegen Tätigkeitsunterbrechung oder –Einstellung, Unannehmlichkeiten, Folgeschäden, usw. Das Vorhandensein fehlerhafter Fliesen setzt weder die Güte der Gesamtlieferung herab noch ist damit die Pflicht des Gesamtersatzes verbunden. Die zeitlichen Beschränkungen der Garantiedauer sind laut dem italienischen Bürgerlichen Gesetzbuch festgelegt.

10. EIGENTUMSVORBEHALT Der Warenverkauf erfolgt mit der Klausel des Eigentumsvorbehalts; deshalb bleiben die gelieferten Produkte, sofern deren Bezahlung laut Vertragsvereinbarungen gänzlich oder teilweise nach der Lieferung zu erfolgen hat, bis zur vollkommenen Bezahlung des Preises Eigentum von Gazzini S.p.A..

11. VERTRAGSABTRETUNG Der Käufer darf seine Stellung im Vertrag oder in einzelnen, aus diesem herrührenden obligatorischen Verhältnissen ohne schriftliche Einwilligung von Gazzini S.p.A. nicht abtreten: Auch in diesem Fall haftet der Käufer weiterhin mit dem Übernehmer solidarisch für die abgetretenen Verpflichtungen.

12. GEWERBLICHES EIGENTUM UND SELEKTIVER VERTRIEB - BESCHRÄNKUNGEN BEIM WEITERVERKAUF Gazzini S.p.A. ist Inhaber und rechtmäßiger Besitzer von Alleinrechten bezüglich Marken, Zeichnungen und Erfinderpateuten. Um die Beachtung der Alleinrechte von Gazzini S.p.A. und die Ansprüche der Endkunden im Hinblick auf die erwarteten Güteeigenschaften auf ein Höchstmaß gewährleisten zu können, liefert Gazzini S.p.A. seine Produkte im Rahmen eines selektiven Vertriebssystems. Die von Gazzini S.p.A. und seinen dazu befugten selektiven Verkaufsstellen gelieferten Produkte sind für die Verlegung beim Endbenutzer bestimmt. Eine andere Form des Weiterverkaufs an weitere Handelsvertreter, die nicht den Endbenutzern entsprechen, ist ohne vorherige schriftliche Einwilligung von Gazzini S.p.A. unzulässig. Die Ware, dessen Weiterverkauf trotz dieses Verbots erfolgte, ist somit als unzulässig zu betrachten und einem unerlaubten Gebrauch der gewerblichen und geistigen Eigentumsrechte von Gazzini S.p.A. gleichzusetzen, wobei Gazzini S.p.A. berechtigt ist, die Beschlagnahme bei jedem Besitzer zu beantragen. Gazzini S.p.A. behält sich das Recht vor, gegen all diejenigen gerichtlich vorzugehen, die zu einem unbefugten Weiterverkauf beteiligt sind.

13. VERTRAGSGESETZ - ZUSTÄNDIGES GERICHT Der Vertrag ist durch das italienische Gesetz, einschließlich der Branchengewohnheiten der Provinz Reggio Emilia, geregelt. Für jegliche aus dem Liefervertrag herrührende Streitigkeit sowohl seitens Gazzini S.p.A. als auch des Käufers ist allein das Gericht Reggio Emilia zuständig. Nur Gazzini S.p.A. kann eine andere zuständige Gerichtsbehörde anrufen.

CATALOGO
GENERALE
2021-2022

Catalogo - Listino Prezzi in vigore da 01/01/2021.

Il presente catalogo e listino prezzi annullano e sostituiscono i precedenti.

Le tonalità dei colori sono indicative.

L'azienda si riserva di modificare i prodotti illustrati nei presenti catalogo e listino prezzi in qualsiasi momento e senza preavviso.

Ceramica Gazzini SpA declina ogni responsabilità dovuta ad eventuali errori e/o omissioni nelle informazioni pubblicate.

Catalogue - Price List in force as of 01/01/2021.

These catalogue and price list cancel and replace all the previous ones.

These colour shades are indicative.

The company reserves the right to modify the products illustrated in these catalogue and price list at any time without prior notice.

Ceramica Gazzini SpA accepts no liability for errors and/or omissions in the information published.

Catalogue - Liste des Prix en vigueur à partir de 01/01/2021.

Le présent catalogue / liste des prix annule et remplace les précédent.

Les nuances des couleurs sont indicatives.

La société se réserve le droit de modifier, à tout moment et sans avis préalable, les produits figurant sur ce catalogue.

La responsabilité de Ceramica Gazzini SpA ne peut être mise en cause dans le cas d'éventuelles omissions et/ou erreurs qui se seraient glissées dans les informations publiées.

Katalog - Preisliste ab 01/01/2021.

Die vorliegenden Katalog und Preisliste annullieren und ersetzen die Vorigen.

Je nach Brand ist die Tonalität annähernd. Muster und Fliesen können deshalb leicht unterschiedlich ausfallen laut DIN Norm.

Die Firma behält sich vor, die in diesen Katalog und Preisliste abgebildeten Produkte jederzeit und ohne Vorankündigung abzuändern.

Ceramica Gazzini SpA lehnt jegliche Haftung für evtl. Fehler bzw. Auslassungen in den veröffentlichten Informationen ab.

MADE IN ITALY



AD project
www.puntodigital.it

3D & photo
www.puntoimmaginesrl.it

LISTINO GENERALE

COLLECTIONS
2021-2022

Codici Prezzo 1° scelta - IVA Esclusa

Codeprice 1st choice - Preisgruppe 1. Wahl - Codeprix 1 ere choix

1.....	0,65	48.....	35,36	95.....	76,96
2.....	2,94	49.....	36,38	96.....	77,04
3.....	4,07	50.....	38,24	97.....	78,00
4.....	4,68	51.....	39,06	98.....	79,04
5.....	6,42	52.....	39,20	99.....	80,00
6.....	7,49	53.....	39,28	100.....	81,00
7.....	8,00	54.....	39,41	101.....	81,32
8.....	8,03	55.....	39,52	102.....	82,16
9.....	8,56	56.....	39,60	103.....	83,46
10.....	9,63	57.....	40,56	104.....	84,24
11.....	10,70	58.....	40,66	105.....	85,60
12.....	11,18	59.....	40,98	106.....	86,00
13.....	11,24	60.....	41,18	107.....	124,12
14.....	11,77	61.....	41,60	108.....	128,40
15.....	12,00	62.....	41,73	109.....	145,60
16.....	12,31	63.....	42,22	110.....	235,40
17.....	12,84	64.....	42,64	111.....	90,00
18.....	13,91	65.....	42,80	112.....	110,00
19.....	14,98	66.....	43,00	113.....	180,00
20.....	15,00	67.....	43,68	114.....	210,00
21.....	15,52	68.....	44,72	115.....	11,25
22.....	16,05	69.....	45,00	116.....	13,50
23.....	17,12	70.....	45,76	117.....	53,00
24.....	17,66	71.....	49,92	118.....	1,95
25.....	18,00	72.....	50,00	119.....	190,00
26.....	19,00	73.....	51,36	120.....	58,00
27.....	19,26	74.....	52,00	121.....	16,50
28.....	20,00	75.....	54,00	122.....	26,70
29.....	20,33	76.....	56,16	123.....	22,50
30.....	20,35	77.....	60,00	124.....	3,50
31.....	21,00	78.....	60,32	125.....	20,60
32.....	21,40	79.....	62,40	126.....	6,60
33.....	21,84	80.....	63,44	127.....	26,40
34.....	23,54	81.....	64,20	128.....	24,70
35.....	24,00	82.....	64,48	129.....	10,00
36.....	25,68	83.....	66,56	130.....	132,00
37.....	26,00	84.....	67,00	131.....	37,50
38.....	27,82	85.....	68,80	132.....	28,60
39.....	28,00	86.....	69,04	133.....	18,50
40.....	28,89	87.....	69,24	134.....	44,00
41.....	28,98	88.....	70,00	135.....	8,80
42.....	29,00	89.....	70,72	136.....	30,80
43.....	29,96	90.....	72,00	137.....	168,00
44.....	32,10	91.....	72,51	138.....	248,00
45.....	33,17	92.....	72,80	139.....	102,00
46.....	34,00	93.....	74,88	140.....	2,70
47.....	35,00	94.....	76,00	141.....	95,00

SU LISTINI E CATALOGHI

Il codice prezzo su □ significa prezzo al **mq.**
Il codice prezzo su ○ significa prezzo al **pz.**
Il codice prezzo su △ significa prezzo al **ml.**

GAZZINI
CERAMICA & DESIGN

GAZZINI
CERAMICA & DESIGN

Ceramica Gazzini SpA - via Milano, 2 - 42048 Rubiera (Reggio Emilia) Italy
Tel. 0522 628112 - 627518 - 628639 - Fax 0522 628437
info@ceramicagazzini.it - www.ceramicagazzini.it

C.F. E P.I. 00140380353 - REG. IMP. REGGIO EMILIA N° 00140380353
CAPITALE SOCIALE I.V. € 546.000,00

